INTERNATIONAL

ŒNOLOGICAL

CODEX



**INTERNATIONAL ORGANISATION
OF VINE AND WINE**

***INTERNATIONAL
ŒNOLOGICAL
CODEX***

2023 ISSUE



INCLUDED

Resolution adopted in Ensenada (Mexico)

20th G.A. – 4 November 2022

Printed in Paris (France)
Legal deposit : January 2023
ISBN : 978-2-85038-063-1

Chapter I: Products used in oenology

Edition 2023

N°	Monograph	Adoption	Sheet name
1.	GENERAL PRINCIPLES	OIV-OENO 602-2022	COEI-1-GENPRI
2.	ALGINIC ACID	OENO 6/2005, OIV/OENO 410/2010	COEI-1-ALGIAC
3.	AMMONIUM CHLORIDE	OENO 13/2000 OENO 4/2007	COEI-1-AMMCHL
4.	AMMONIUM HYDROGEN SULFITE	OENO 14/2000 OENO 3/2007	COEI-1-AMMHYD
5.	AMMONIUM SULFATE	OENO 16/2000	COEI-1-AMMSUL
6.	ANTI-FOAMING AGENTS	OENO 5/94 OENO 17/2000	COEI-1-ACIGRA
7.	ARGON	OENO 31/2004	COEI-1-ARGON
8.	ASCORBIC ACID	OENO 18/2000 OENO 4/2007	COEI-1-ASCACI
9.	LACTIC ACID BACTERIA	OENO 3/89 OENO 15/2003 OIV/OENO 328/2009 OIV-OENO 494-2012	COEI-1-BALACT
10.	BENTONITES	OENO 11/2003, OIV-OENO 441-2011	COEI-1-BENTON
11.	BETA-GLUCANASE	OENO 27/2004	COEI-1-BGLUCA
12.	CALCIUM CARBONATE	OENO 20/2000 OENO 4/2007	COEI-1-CALCAR
13.	POTASSIUM CARBONATE	AG 8/78-OEN OIV-OENO 579-2018	COEI-1-POTCAR
14.	CALCIUM PHYTATE	OENO 21/2000	COEI-1-CALPHY
15.	CALCIUM TARTRATE	OENO 22/2000	COEI-1-CALTAR
16.	CALCIUM SULFATE	OIV-OENO 644-2020	COEI-1-CALSUL
17.	CARAMEL	OENO 20/2004	COEI-1-CARAME
18.	CARBON DIOXIDE	OENO 26/2000	COEI-1-DIOCAR
19.	CASEINS	OENO 12/2003, OIV-OENO 555-2015	COEI-1-CASEIN
20.	CATION-EXCHANGE RESINS	OENO 4/95 OENO 43/2000	COEI-1-RESECA
21.	CARBON (OENOLOGICAL)	OENO 7/2007, OIV-OENO 604-2018	COEI-1-CHARBO
22.	CARBOXYMETHYLCELLULOSE (CELLULOSE GUM, CMC)	OIV/OENO 366/2009	COEI-1-CMC
23.	CELLULOSE	OENO 08/2002	COEI-1-CELLUL
24.	CELLULOSE POWDERED	OIV-OENO 681-2022	COEI-1-POWCEL
25.	CHITIN-GLUCAN	OIV/OENO 367/2009	COEI-1-CHITGL
26.	CHITOSAN	OIV/OENO 368/2009	COEI-1-CHITOS
27.	CITRIC ACID, MONOHYDRATE	OENO 23/2000	COEI-1-CITACI

INTERNATIONAL CENOLOGICAL CODEX

COEI-0-TABCON: 2023

28.	COLLOIDAL SILICON DIOXIDE SOLUTION	OENO 4/87 OENO 44/2000 OIV-OENO 617-2019	COEI-1-DIOSIL
29.	COPPER SULFATE, PENTAHYDRATE	OENO 25/2000	COEI-1-CUISUL
30.	COPPER CITRATE	OIV-OENO 413-2011	COEI-1-CUICIT
31.	D,L-TARTARIC ACID	AG 3/80-OEN OENO 48/2000 OENO 4/2007	COEI-1-DLTART
32.	DIAMMONIUM HYDROGEN PHOSPHATE	OENO 15/2000	COEI-1-PHODIA
33.	DIATOMITE	OENO 10/2002	COEI-1-DIATOM
34.	DIMETHYL DICARBONATE	OENO 25/2004 OENO 4/2007	COEI-1-DICDIM
35.	EGG (ALBUMIN OF)	OENO 32/2000 OIV-OENO 650-2019	COEI-1-OEUALB
36.	ELECTRODIALYSIS MEMBRANES	OENO 5/95 OENO 29/2000	COEI-1-MEMELE
37.	BIPOLAR ELECTRODIALYSIS MEMBRANES	OIV-OENO 411-2011	COEI-1-MEMBIP
ENZYMES			
38.	ENZYMATIC PREPARATIONS	AG 4/82-OEN AG 6/84-OEN OENO 6/95 OENO 14/2003 OIV/OENO 365/2009 OIV-OENO 485-2012	COEI-1-PRENZY
39.	ARABINANASE ACTIVITY	OIV-OENO 412-2012	COEI-1-ACTARA
40.	XYLANASE ACTIVITY	OIV-OENO 573-2018	COEI-1-XYLANA
41.	BETA-GLUCANASE ACTIVITY (β 1-3, β 1-6)	OIV/OENO 340/2010, OIV-OENO 488-2013	COEI-1-ACTGLU
42.	CINNAMOYL ESTERASE ACTIVITY	OENO 6/2007, OIV-OENO 487-2013	COEI-1-CINEST
43.	CELLULASE	OENO 8/2008 OIV-OENO 486B-2012	COEI-1-ACTCEL
44.	GLYCOSIDASE	OENO 5/2007; OIV-OENO 451-2012; OIV-OENO 489-2012	COEI-1-GLYCOS
45.	PECTINLYASE ACTIVITY	OIV/OENO 314/2009; OIV-OENO 491-2012	COEI-1-ACTPLY
46.	POLYGALACTURONASE ACTIVITY	OENO 10/2008 ; OIV-OENO 364-2012	COEI-1-ACTPGA
47.	PROTEASES (ASPERGILLOPEPSINE I)	OIV-OENO 625-2021	COEI-1-PROTEA
48.	PECTINMETHYLESTERASE ACTIVITY	OENO 9/2008; OIV-OENO 363-2012	COEI-1-ACTPME
49.	UREASE	OENO 5/2005	COEI-1-UREASE
50.	FISH GLUE	OENO 24/2000	COEI-1-COLPOI
51.	FILTER SHEET	OIV-OENO 629-2021	COEI-1-PLAQFI
52.	GELATINE	OENO 13/2003	COEI-1-GELATI
53.	GLUTATHIONE	OIV-OENO 571-2017	COEI-1-GLUTAT
54.	GRAPE SUGAR	OENO 4/87 OENO 2/88	COEI-1-SUCRAI

INTERNATIONAL OENOLOGICAL CODEX

COEI-0-TABCON: 2023

		OENO 47/2000, OIV-OENO 419A-2011. OIV- OENO 419B-2012 OIV-OENO 419C-2015 OIV-OENO 419D-2015	
55.	GUM ARABIC	OENO 27/2000	COEI-1-GOMARA
56.	KAOLIN	OENO 28/2000	COEI-1-KAOLIN
57.	INACTIVATED YEASTS	OIV-OENO 459-2013	COEI-1-INAYEA
58.	INACTIVATED YEASTS (GLUTATHION)	OIV-OENO 603-2018	COEI-1-LEVGLU
59.	L(+) TARTARIC ACID	OENO 49/2000 OENO 4/2007	COEI-1-LTARAC
60.	LACTIC ACID	OENO 29/2004 OENO 4/2007	COEI-1-ACILAC
61.	LIQUID SULFUR DIOXIDE	OENO 46/2000	COEI-1-SOUDIO
62.	LYSOZYME	OENO 15/2001 OENO 4/2007	COEI-1-LYSOZY
63.	MALIC ACID	OENO 30/2004	COEI-1-ACIMAL
64.	METATARTARIC ACID	OENO 31/2000	COEI-1-METACI
65.	MYCROCISTALLINE CELLULOSE	OENO 09/2002	COEI-1-CELMIC
66.	NANOFILTRATION MEMBRANES	OIV-OENO 482-2013	COEI-1-NANMEM
67.	NITROGEN	OENO 19/2000	COEI-1-AZOTE
SPECIFIC MONOGRAPHS ON OENOLOGICAL TANNINS			
68.	OENOLOGICAL TANNINS	OENO 12/2002 OENO 6/2008 OENO 5/2008 OIV/OENO 352/2009, OIV-OENO 554-2015 OIV-OENO 574-2017 OIV-OENO 624-2022	COEI-1-TANINS
69.	PROCYANIDINS/ PRODELPHINIDINS TANNINS	OIV-OENO 675A-2022	COEI-1-PROCYA
70.	ELLAGITANNINS	OIV-OENO 675B-2022	COEI-1-ELLAGI
71.	GALLIC TANNINS	OIV-OENO 675C-2022	COEI-1-GALLOT
72.	PROFISSETINIDINS/ PROROBITENIDINS TANNINS	OIV-OENO 675D-2022	COEI-1-PROFIS
73.	OXYGEN	OENO 32/2004	COEI-1-OXYGEN
74.	PERLITE	OENO 10/2003	COEI-1-PERLIT
75.	POLYVINYLMIDAZOLE /POLYVINYLPIRROLIDONE	OIV-OENO 262-2014 OIV-OENO 605-2017	COEI-1-PVIPVP
76.	POLYVINYL POLYPYRROLIDONE	AG 2/85-OEN OENO 2/88 OENO 11/2002 OENO 4/2007	COEI-1-PVPP
77.	POTASSIUM POLYASPARTATE	OIV-OENO 572-2017 OIV-OENO 645-2020	COEI-1-POTPOL
78.	POTASSIUM ALGINATE	OENO 33/2000, OIV/OENO 410/2010	COEI-1-POTALG
79.	POTASSIUM ANHYDROUS SULFITE	OENO 34/2000	COEI-1-POTANH
80.	POTASSIUM CASEINATE	OENO 35/2000 OIV-OENO 673-2021	COEI-1-POTCAS
81.	POTASSIUM D,L-TARTRATE	OENO 42/2000	COEI-1-POTRAC

INTERNATIONAL OENOLOGICAL CODEX

COEI-0-TABCON: 2023

82.	POTASSIUM HEXACYANOFERRATE (II)	OENO 36/2000	COEI-1-POTFER
83.	POTASSIUM HYDROGEN CARBONATE	OENO 37/2000	COEI-1-POTBIC
84.	POTASSIUM HYDROGEN SULFITE	OENO 38/2000 OIV-OENO 646-2019	COEI-1-POTBIS
85.	POTASSIUM HYDROGEN TARTRATE	OENO 39/2000	COEI-1-POTBIT
86.	POTASSIUM SORBATE	OENO 40/2000	COEI-1-POTSOR
87.	POTASSIUM-L(+)- TARTRATE	OENO 41/2000	COEI-1-POTTAR
88.	PROTEIN PLANT ORIGIN	OENO 28/2004, OIV-OENO 495-2013, OIV-OENO 557-2015 OIV-OENO 575-2016	COEI-1-PROVEG
89.	RECTIFIED ALCOHOL OF AGRICULTURAL ORIGIN	C 6/77-OEN OENO 11/2000	COEI-1-ALCAGR
90.	RECTIFIED ALCOHOL OF VITIVINICULTURAL ORIGIN	C 6/77-OEN OENO 12/2000	COEI-1-ALCVIT
91.	REVERSE OSMOSIS MEMBRANES	OENO 3/95 OENO 30/2000	COEI-1-MEMOSM
92.	SELECTIVE PLANT FIBRES	OIV-OENO 578-2017	COEI-1-FIBVEG
93.	SORBIC ACID	OENO 45/2000 OENO 4/2007	COEI-1-SORACI
94.	SKIM MILK	OENO 7/2008	COEI-1-LAIECR
95.	STYRENE-DIVINYLBENZENE BEADS	OIV-OENO 643-2020	COEI-1-STYDVB
96.	THIAMINE HYDROCHLORIDE	OENO 50/2000	COEI-1-THIAMIN
97.	ULTRAFILTRATION MEMBRANES	OIV-OENO 481-2013	COEI-1-ULTMEM
98.	PIECES OF OAK WOOD	OENO 3/2005, OIV/OENO 430/2010 OIV-OENO 406-2011	COEI-1-WOOPIE
99.	WOOD FOR WINE CONTAINERS	OENO 4/2005	COEI-1-WOOCON
100.	SACCHAROMYCES SPP. SELECTED YEASTS	OIV-OENO 576A-2017	COEI-1-SACCHA
101.	NON SACCHAROMYCES SPP. SELECTED YEASTS	OIV-OENO 576B-2017	COEI-1-NOSACC
102.	YEAST MANNOPROTEINS	OENO 26/2004 OIV-OENO 674-2022	COEI-1-MANPRO
103.	YEAST PROTEIN EXTRACTS	OIV-OENO 452-2012	COEI-1-EPLEV
104.	YEAST AUTOLYSATES	OIV-OENO 496-2013	COEI-1-AUTLYS
105.	YEAST HULLS	OENO 4/87 OIV-OENO 497-2013	COEI-1-YEHULL
106.	ZEOLITE Y-FAUJASITE	OIV-OENO 506-2016	COEI-1-ZEOLIT

Chapter I:

For the record in French – monographs being revised (green part)

Monograph	Adoption	Sheet name
Sodium (Alginate de)	Edition 1978	COEI-V-1-SODALG

Chapter II: Analytical and Control Techniques

	Title	Adoption	Sheet name
107.	5-(hydroxymethyl)furfural - Determination	OENO 18/2003	COEI-2-HMF
108.	Arsenic - determination by AAS	OENO 18/2003	COEI-2-ARSENI
109.	Bacteriological Control	AG 4/82-OEN OENO 16/2003 OENO 17/2003, OIV/OENO 328/2009, OIV/OENO 329/2009, OIV- OENO 632-2021	COEI-2-CONBAC
110.	Benzo[a]pyrene - Determination	OENO 18/2003	COEI-2-HYDCAR
111.	Detection of biogenic amines by TLC	OIV/OENO 348/2010	COEI-2-AMIBIO
112.	Bromine - Index	OENO 18/2003	COEI-2-IBROME
113.	Cadmium - determination by AAS	OENO 18/2003	COEI-2-CADMIU
114.	Calcium - determination by AAS	OENO 18/2003	COEI-2-CALCIU
115.	Chlorides - Research	OENO 18/2003	COEI-2-CHLORU
116.	Chrome - determination by AAS	OENO 18/2003	COEI-2-CHROME
117.	Cinders Sulfuric - Total	OENO 18/2003	COEI-2-CENDRE
118.	Copper - determination by AAS	OENO 18/2003	COEI-2-CUIVRE
119.	Gas control by GC	OENO 18/2003	COEI-2-CONGAZ
120.	Heavy metals - Research	OENO 18/2003	COEI-2-METAUX
121.	Iron - determination by AAS	OENO 36/2000 OENO 18/2003	COEI-2-FER
122.	Lead - determination by AAS	OENO 18/2003	COEI-2-PLOMB
123.	Mercury - Determination	OENO 18/2003	COEI-2-MERCUR
124.	Mineralisation methods before determination by AAS	OENO 18/2003	COEI-2-MINERA
125.	Nickel - determination by AAS	OENO 18/2003	COEI-2-NICKEL
126.	Potassium - determination by AAS	OENO 18/2003	COEI-2-POTASS
127.	Determination of the ability of an enzymatic preparation to interrupt pectic chains by measuring viscosity	OIV/OENO 351/2009	COEI-2-VISCPE
128.	Saccharose - Grape sugar - Determination	AG 4/81-OEN OENO 18/2003	COEI-2-SUCSAC
129.	Selenium - determination by AAS	OENO 18/2003	COEI-2-SELENI
130.	Sodium - determination by AAS	OENO 18/2003	COEI-2-SODIUM
131.	Sulphates - Research	OENO 18/2003	COEI-2-SULFAT
132.	Tantalisation of platforms	OENO 18/2003	COEI-2-TANTAL
133.	Total Nitrogen - Determination	OENO 18/2003	COEI-2-AZOTOT
134.	Zinc - determination by AAS	OENO 18/2003	COEI-2-ZINC

Chapter III: Reagents and Titrated Solutions

For the record in French –being revised (green part)

	Title	Adoption	Sheet name
135.	Reagents and Titrated Solutions	OENO 19/2003	COEI-3-REASOL

Warning:

In 2000, the OIV adopted 40 monographs of products used in oenology, which make up the new edition of the **International Oenological Codex**, and are listed in this binder on white paper.

This important scientific contribution is being pursued in order to update the remaining monographs and in order to add new ones suited to the **International Code of Oenological Practices** index cards.

Moreover, the O.I.V. Sub-Commission of Methods of Analysis and Appraisal of Wines in charge with the revising of the International Oenological Codex has also undertaken the task of revising Chapter 2 « Analytical and Control techniques » and Chapter 3 « Reagents and titrated solutions ». This work thus led to the adoption in 2003 of new monographs of the chapters concerned.

Introduction

The **International Oenological Codex** gathers descriptions of the main chemical, organic and gas products used in the making and the keeping of wines.

Conditions for usage and the directions and the limits of use are set out in the **International Code of Oenological Practices**. The authorization for usage comes under national legislation.

On one hand, the identifying characteristics and the degree of purity are described in detail herein, in addition to the minimum efficiency required to be qualified as "*conforming to the International Oenological Codex*".

On the other hand, the definition or the formula, with possible synonymy, of every product is provided. Molecular weight, general characteristics, and in particular the solubilities are mentioned. To avoid any possible error, simple means of identification are indicated.

Each monograph indicates the research necessary to reveal and dose the impurities and their acceptable limit. These limits have been set for some of these including:

- selenium, arsenic, heavy metals etc., in order to prevent oenological products, given the maximum dose for its usage, to bring about even the smallest toxic effect,
- iron, copper, calcium, in order to prevent all harmful effects on wine quality and its aspect.
-

In terms of holdings of other products including chlorides, sodium, sulfates, etc. the limits have been set fairly large because these products are not toxic and wines naturally contain these products in larger amounts than possibly do oenological products.

General observation: Unless otherwise indicated, solubilities are expressed at 20 °C in grams of solvent for one gram of product..

Chapter I
Products
used in œnology

**GENERAL PRINCIPLES TO TAKE INTO ACCOUNT IN THE ASSESSMENT OF
OENOLOGICAL PRACTICES AND SUBSTANCES COMPOSING OENOLOGICAL
PRODUCTS**

(OIV-OENO 602-2022)

Oenological practices:

- are safe biological, physical and chemical practices intended for the production and preservation of vitivinicultural products,
- preserve the natural and essential characteristics and composition of wine,
- should not cause consumer confusion or facilitate this.

Wherever possible and reasonable, preference should be given to substances that are extracted from grapes/substances of vitivinicultural origin.

Oenological practices and the use of oenological substances should not mask the effects of the use of defective raw materials, faulty raw materials, or unhygienic practices¹.

Taking this into consideration the OIV establishes a specific description of each oenological practice and any use of oenological substances, including its objectives, purposes and conditions of use. Oenological practices and the use of oenological substances recommended and published by OIV shall only be used for the purposes described and, in the manner, described to provide a benchmark for good manufacturing practice.

Oenological practices and oenological substances are used:

- to prevent or eliminate wine defects (oxidation, bacterial contamination, tartaric precipitation, etc.),
- to improve the process of winemaking (control the fermentations, improve the filterability, improve clarification,...),
- to improve the storage capacity or stability of the vitivinicultural product and maintenance of its organoleptic qualities,
- as additives or processing aids, while the status of the substance depends on their use.

¹ "hygiene", means the measures and conditions necessary to control hazards and to ensure fitness for human consumption of wine, wine-based beverages, table grapes, raisins and other vine-based products taking into account its intended use

There is a sufficient technological need to justify the use of the oenological substance, or the treatment gives evident advantages, economically or technically, compared to the present practices and consumers are not misled through the use of the oenological treatment agent; the oenological substance provides advantages to consumers and consequently fulfils one or several objectives such as:

- preservation of the nutritive quality of the vitivincultural products,
- improvement of the storage capacity or stability of the vitivincultural product and maintenance of its organoleptic qualities.

The OIV establishes a specification for each oenological substance concerning the origin, purity and other necessary indications.

The OIV evaluates and develops new oenological practices or revises those that already exist, also taking into account environmental impact/sustainability according to technological innovations.

The OIV recommends that:

- the quantity of an oenological treatment agent added in the elaboration of a product shall be limited to the lowest possible level necessary to accomplish its desired effect,
- the quantity of the oenological treatment agent that as a result of its use transforms to another product not intended to accomplish any physical or other technical effect in the vitivincultural product itself, is reduced to the extent reasonably possible.

The OIV recommends maximum numerical use levels for oenological substances with an acceptable daily intake (ADI) set by JECFA or other Food Safety Authorities, also taking account of the opinion of the OIV's "Food Safety" Group. The OIV also recommends numerical limits for best use of the technological function and/or for quality purposes on the basis of experimental data analysed by its own experts. In the absence of fixed numerical limits from the OIV, the OIV recommends oenological substances shall be used at levels established for GMP, which are the lowest levels possible to provide a specific technological function.

ALGINIC ACID**Sin no. 400****C.A.S. no.: 9005-32-7**

OENO 6/2005

OIV-OENO 410/2010

1. SUBJECT, ORIGIN AND SCOPE

Alginate acid is a colloidal polysaccharide extracted from various varieties of brown algae in particular from Laminaria. The monomers constituting the α -L-glucuronic acid and β -D-mannuronic acid are bound in pairs as connections of the type 1 \rightarrow 4



A clarifying agent, which, after being neutralized before use by potassium chloride, or potassium carbonate or potassium hydrogenocarbonate can be added to the drawn-off liquid, designed to carry out the second fermentation of sparkling wines (foam formation). Alginate acid is made up on average of 200 basic units of uronic acids. Their molecular weight ranges between 10 000 and 600 000 U.

2. LABELING

The concentration of alginate acid must be indicated on the label, as well as the conditions of safety and conservation.

3. CHARACTERISTICS

Alginate acid exists in powder or filament form, or as amorphous granules of a yellowish white to brown color, insoluble in pure water and the various organic solvents. It can dissolve in water alkalized by sodium carbonate, sodium hydroxide or trisodium phosphate.

4. IDENTIFYING CHARACTERISTICS**4.1 pH**

A suspension of 3% alginate acid in water has a pH ranging between 2 and 3.5.

4.2 Differentiation with other polysaccharides

An alginate acid solution of 5 g/l in sodium hydroxide (dissolve 4.3 g of sodium hydroxide in water and complete to 100 ml)

precipitate in gelatinous form by adding a fifth of volume of a 2.5% solution of calcium chloride.

Furthermore, an addition of a half volume of a solution saturated with ammonia sulfate to the solution previously described does not cause any turbidity.

These two tests can be used to differentiate alginic acid from other polysaccharides that may be used in foodstuffs or pharmaceuticals.

4.3 Organoleptic characteristics

Alginic acid must have no taste, or abnormal odor.

5. TESTS

All the limits described below refer to the dry weight of alginic acid.

5.1 Insoluble in a solution of sodium hydroxide

Dissolve by prolonged magnetic agitation 1 g of alginic acid weighed with precision in 100 ml of a solution of sodium hydroxide (dissolve 4.3 g of sodium hydroxide in water and complete to 100 ml), centrifuge, decant, and wash the residue 5 times with distilled water, with centrifugation and drainage of the washwater each time. Transfer all the residue using distilled water to a Gooch filter that has been tared beforehand (filter made of sintered glass of low porosity), dry for 1 hour at 105°C and weigh again.

The rate of insoluble should not exceed 2% in relation to the dry weight of the alginic acid.

5.2 Loss on desiccation

Determine until constant weight, on a test specimen of 2 g, the loss of weight, at 100-105°C, the alginic acid must be lower than 15 p. 100

5.3 Sulfuric ash

Proceed as indicated in chapter II of the international oenological Codex. The sulfuric ash content should not be higher than 8 p 100 in weight of the alginic acid.

5.4 Preparation of the solution for tests

After weighing the ashes, dissolve them in 2 ml of concentrated hydrochloric acid (R) and 10 ml of water. Heat to activate the dissolution and add water until a volume equal to 25 times the

weight of the dry alginic acid is obtained. 1 ml of this solution contains the mineral matter of 0.04 g of dry alginic acid.

5.5 Lead

On the solution prepared for tests (5.4), to carry out the dosage of lead according to the method described in chapter II of the international oenological Codex.

The lead content must be lower than 5 mg/kg.

5.6 Cadmium

On the solution prepared for the tests (5.4), determine the cadmium using the method described in chapter II of the international oenological Codex.

The cadmium content must be lower than 1 mg/kg.

5.7 Mercury

Determine the mercury using the method described in Chapter II of the international oenological Codex.

The mercury content must be lower than 1 mg/kg.

5.8 Arsenic

On the solution prepared for the tests (5.4), determine the arsenic using the method described in Chapter II of the international oenological Codex.

The arsenic content must be lower than 3 mg/kg.

5.9 Bacteriological control

Proceed as indicated in chapter II of the international Oenological Codex for each parameter.

Limit: total viable microorganisms: less than 5×10^3 CFU/g.

5.10 Coliforms

The number of coliforms must be lower than or equal to 1 per g.

5.11 Staphilococca

The number of staphilococca (β -haemolytics with positive coagulase) must be lower than or equal to 1 per g.

5.12 Salmonella

The number of salmonella must be lower than 1 per 100 g.

5.13 Yeast

Limit concentration: 5×10^2 CFU per g of preparation.

5.14 Lactic bacteria

Limit concentration: 10^2 CFU per g of preparation.

5.15 *Lactobacillus sp.*

Limit concentration: 10 CFU per g of preparation.

5.16 *Pediococcus sp.*

Limit concentration: absence in a sample of 10 g of preparation.

5.17 Acetic bacteria

Limit concentration: 10^3 CFU per g of preparation.

5.18 Moulds

Limit concentration: 5×10^2 CFU per g of preparation.

6. STORAGE

Alginate acid must be kept in sealed bags.

CALCIUM (ALGINATE)

SIN N°: 402

1. OBJECT, ORIGIN AND SCOPE OF APPLICATION

Calcium alginate is obtained from a 1 % aqueous solution of potassium alginate or alginate acid placed in contact with a 20 % aqueous solution of calcium chloride. Beads of calcium alginate can be produced by dropping droplets of potassium alginate solution into a calcium chloride solution.

Beads of calcium alginate, dry or wet, can contain yeasts or lactic bacteria, dry or wet. They are used for foam forming purposes in the bottle for sparkling wine or to restart alcoholic fermentation in still wines or to start the malolactic fermentation.

These beads can be coated with a double layer of potassium or calcium alginate or with colloidal silica to prevent the precipitation of the yeasts or bacteria incorporated into the beads.

2. LABELLING

The label should indicate the product's purity and the safety and storage conditions for calcium alginate, the yeasts or bacteria incorporated into the beads, the expiration date and the lot number.

3. CHARACTERISTICS

Calcium alginate is a translucent gel, which is insoluble in water and wine. It only dissolves in a sodium metaphosphate solution.

An alginic acid precipitate is also produced if 1 ml of sulfuric acid diluted to 10 % (R) is added to 10 ml of an aqueous 1 % (m/v) suspension of calcium alginate.

AMMONIUM CHLORIDE
Ammonia Hydrochloride
Ammonii Chloridum

NH₄Cl=53.50

SIN NO. : 510

OENO 13/2000

OENO 4/2007

1. OBJECTIVE, ORIGIN AND DOMAIN OF APPLICATION

This product is used as a fermentation activator and is reserved for fermentation operations. It makes available ammonium ions which can be directly assimilated by the yeast.

Statutory limits regulate the amount of ammonium added.

2. LABELING

The concentration of this product should be indicated on the label, including cases in which it is mixed. In addition, safety and storage conditions should be stipulated.

3. CENTESIMAL COMPOSITION

Cl	66.22
NH ₃	31.78
N	28.17

4. PROPERTIES

Colorless, odorless crystals with a fresh, salty and piquant taste. It sublimates without decomposing and is stable in air.

5. SOLUBILITY

Water at 20 °C	350.8 g/l
Water at 100 °C	758 g/l
Alcohol, 95% by vol.	13.3 g/l

6. IDENTIFYING CHARACTERISTICS

Aqueous solutions of ammonium chloride produce reactions of ammonium and those of chloride.

7. TESTING

7.1. Sulfur Ash

When quantified as indicated in the Annex, the sulfur ash content of the ammonium chloride should not be greater than 0.2 per 100.

7.2. Preparing the solution for tests

Prepare an aqueous solution from NH_4Cl crystals at 10 per 100 (m/v).

7.3. Sulfates

To 1 ml of solution prepared for tests under paragraph 7.2, add 2 ml of hydrochloric acid diluted to 10 pp 100 (m/v) (R), 17 ml of water and 2 ml of barium chloride solution (R). The mixture should be clear, or else the opalescence observed after 15 minutes should be less than that of the control solution prepared as indicated in the Annex. (Sulfate content expressed in terms of sulfuric acid should be less than 1 g/kg).

7.4. Nitrates

Mix 5 ml of concentrated sulfuric acid (R) and 0.5 ml of an extemporaneously prepared iron(II) sulfate solution at 5 pp 100 in a test tube. Without mixing, pour 5 ml of the solution prepared under paragraph 7.2. No coloration should be observed at the surface line separating the two solutions.

7.5. Phosphates

To 0.5 ml of the solution prepared for testing under Paragraph 7.2, add 5 ml of water and 10 ml of nitro-vanadomolybdic (R) reagent. Leave in contact for 15 minutes at 20 °C. If a yellow coloration appears, it should be less intense than that obtained by adding 0.5 ml of a solution of 0.05 g of phosphorous per liter (R), 5 ml of water and 10 ml of nitro-vanadomolybdic (R) reagent. (Phosphate content expressed in terms of phosphorous less than 500 mg/kg).

7.6. Iron

To 5 ml of solution prepared under paragraph 7.2, add 1 ml of concentrated hydrochloric acid (R), one drop of 2 pp 100 potassium permanganate and 2 ml of 5 pp 100 potassium thiocyanate (R).

If a red coloration appears, it should be less intense than that of a control prepared with 2.5 ml of an iron(III) solution containing 0.01 g of iron per liter (R), 2.5 ml of water and the same quantities of the same reagents. (Iron content should be less than 50 mg/kg).

The iron may also be quantitatively analyzed using atomic absorption spectrometry, in accordance with the method detailed in the Compendium.

7.7. Arsenic

Using the method indicated in the annex, test for arsenic in the test solution prepared in accordance with Paragraph 7.2. (Arsenic content should be less than 3 mg/kg.)

7.8. Lead

Using the method described in the Compendium, quantify the lead in the solution obtained under Paragraph 7.2. (Lead content should be less than 2 mg/kg.)

7.9. Mercury

Using the method described in the annex, test for mercury in the solution prepared for testing under Paragraph 7.2. (Mercury content should be less than 1 mg/kg.)

7.10. Quantitative Ammonia Analysis

Dilute the solution prepared for testing under paragraph 7.2 to one-tenth strength, then place 10 ml of this dilute solution (i.e., 0.1 g of ammonium chloride) in a steam distillation device. Add 10 ml of 30% sodium hydroxide (R) and distill 100 ml. Quantify the distilled ammonia using 0.1 M hydrochloric acid. Let n be the number of milliliters used:

100 g of ammonium chloride contains 1.7 n g of ammonia (NH_3). (Ammonia content greater than 31.5 pp 100).

7.1. Quantitative Hydrochloric Acid Analysis

Take a 10 ml sample of the solution prepared for testing under paragraph 7.2, which has been diluted to one-tenth strength. Place the sample in a cylindrical flask. Add 20 ml of 0.1 M silver nitrate solution, 1 ml of concentrated nitric acid (R), 5 ml of iron(III) sulfate solution and 10 pp 100 of ammonium (R). Titrate the excess silver nitrate with a 0.1 M potassium thiocyanate solution. Let n be the number of milliliters used:

100 g of ammonium chloride contains 3.65 (20- n) g of hydrochloric acid (HCl). (Hydrochloric acid content greater than 67.5 pp 100).

8. STORAGE

Ammonium chloride must be stored in water-tight containers away from heat.

AMMONIUM HYDROGEN SULFITE**Ammonium bisulfite****NH₄HSO₃ = 99.07**

OENO 14/2000

OENO 3/2007

1. OBJECTIVE, ORIGIN AND SCOPE OF APPLICATION

This product falls in the category of preservatives and is used exclusively for fermentation operations. It makes available sulfur dioxide and ammonium ions, which can be directly assimilated by the yeast. There are regulatory restrictions on the amount of ammonium that can be added and on sulfur dioxide content.

2. LABELING

The concentration of this product, as well as the safety and storage conditions, should be indicated on the label.

3. CENTESIMAL COMPOSITION

NH ₃	17.16
SO ₂	64.67

4. PROPERTIES

Ammonium hydrogen sulfite always takes an aqueous solution form. This solution emits a piquant sulfur dioxide odor.

5. SOLUBILITY

Water at 60 °C	847 g/l
Alcohol, 95% by vol.	Slightly soluble

6. IDENTIFYING CHARACTERISTICS

Aqueous solutions of ammonium hydrogen sulfite produce reactions of ammonium (release of ammonia in the presence of sodium hydroxide when heated) and sulfur dioxide (filter paper soaked in potassium iodate and starch turns blue).

TESTS**7.1. Sulfur Ash**

As quantified as indicated in the Annex, the proportion of ammonium hydrogen sulfite ash should not be greater than 0.2 per 100.

7.2. Preparing the Solution for Tests

Prepare a 10 pp 100 (m/v) solution.

7.3. Iron

To 5 ml of the solution prepared for testing under paragraph 2, add 1 ml of concentrated hydrochloric acid (R), one drop of 2 pp 100 potassium permanganate (R) and 2 ml of 5 pp 100 potassium thiocyanate (R).

If a red colorating appears, it should be less intense than that of a control prepared with 2.5 ml of an iron(III) solution of 0.01 g of iron per liter (R), 2.5 ml of water and the same quantities of the same reagents. (Iron content should be less than 50 mg/kg).

The iron may also be quantified by means of atomic absorption spectrometry, using the technique described in the Compendium.

7.4. Lead

Use the method detailed in the Compendium on the solution in a concentration of 10 pp 100 prepared for testing (under 7.2) and diluted to one one-twentieth.

7.5. Mercury

Test for mercury in the solution prepared for testing (under 7.2) using the technique detailed in the annex. (Mercury content should be less than 1 mg/kg.)

7.6. Arsenic

Using the method indicated in the Annex, test for arsenic in 2 ml of the test solution prepared for testing in accordance with paragraph 7.2. (Arsenic content should be less than 3 mg/kg).

7.7. Quantitative Ammonia Analysis

Dilute the solution prepared for testing under paragraph 7.2 to one-tenth strength, then place 10 ml of this dilute solution (0.10 g of ammonium hydrogen sulfite) in a steam distillation device (described in the annex). Add 10 ml of 30 pp 100 sodium hydroxide (R) and distill 100 ml. Quantify the distilled ammonia using 0.1 M hydrochloric acid. Let n be the number of milliliters used:

100 g of ammonium hydrogen sulfite contain 1.7 n g of ammonia (NH₃). Ammonia content should be greater than 16.5 pp 100 (m/m).

7.8. Quantitative Sulfur Dioxide Analysis

In a 200 ml conical flask, place 50 ml of cold water, then 5 ml of the freshly prepared ammonium hydrogen sulfite solution. Titrate with 0.05 M iodine in the presence of starch. Let n be the volume of iodine used.

SO₂ content per 100 g: 6.4n

Ammonium hydrogen sulfite should contain at least 62 pp 100 SO₂.

7. STORAGE

Ammonium hydrogen sulfite solutions should be stored in hermetically sealed containers away from heat and cold.

AMMONIUM SULFATE
Ammonium sulfuricum
(NH₄)₂SO₄ = 132.10
SIN NO. 517
OENO 16/2000

1. OBJECTIVE, ORIGIN AND SCOPE OF APPLICATION

This product is used as a fermentation activator and is reserved for fermentation operations. It adds ammonium ions that can be directly assimilated by the yeast. The sulfates added are completely soluble in wine.

Statutory restrictions govern the addition of ammonium.

2. LABELING

The concentration of this product should be indicated on the label, including mixtures. In addition, safety and storage conditions should be noted.

3. CENTESIMAL COMPOSITION

H₂SO₄ 74.22
NH₃ 25.78
SO₃ 60.59
N 21.20

4. PROPERTIES

Transparent, anhydrous crystals with a bitter, pungent taste, which are similar to potassium sulfate crystals, with which this salt is isomorphous.

5. SOLUBILITY

Water at 20 °C 509 g/l
Water at 100 °C 1040 g/l
Alcohol, 90% by vol. Insoluble
Acetone Insoluble

6. IDENTIFYING CHARACTERISTICS

Solutions of this salt in water in a concentration of 1 pp 100 (m/v) has a pH of approximately 5.5. This solution allows reactions of ammonium and those involving sulfates.

7. TESTS

7.1. Sulfur Ash

The concentration of sulfur ash of ammonium sulfate prepared as explained in the annex in a test sample of 1 g must not exceed 5 g/kg.

7.2. Preparing the Solution for Tests

Prepare a 10 pp 100 (m/v) solution.

7.3. Chlorides

To 0.5 ml of the solution prepared for testing under paragraph 7.2, add 14.5 ml of water, 5 ml of nitric acid (R) diluted to a concentration of 10 pp 100 and 0.5 ml of 5 pp 100 silver nitrate solution (R). After 15 minutes at rest in the dark, there should be no clouding ; or else, any clouding visible should be less intense than that observed in the control prepared as indicated in the annex. (Hydrochloric acid content must be less than 1 g/kg).

7.4. Phosphates

To 0.5 ml of the solution prepared for tests under paragraph 7.2, add 5 ml of water and 10 ml of nitro-vanadomolybdc reagent (R). Leave in contact for 15 minutes at 20 °C. If a yellow coloring appears, it should be less intense than that obtained by adding, to 0.5 g of a solution containing 0.05 g phosphorous per liter, 5 ml of water and 10 ml of nitro-vanadomolybdc reagent. (Phosphate content expressed in terms of phosphorous should be less than 500 mg/kg).

7.5. Nitrates

Mix 5 ml of concentrated sulfuric acid (R) and 0.5 ml of an previously prepared iron(II) sulfate solution in a concentration of 5 pp 100 (m/v) in a test tube. Without mixing, pour 5 ml of the solution obtained by dissolving 2 g of ammonium sulfate in 10 ml of water. No coloring should be observed at the surface separating the two solutions

7.6. Iron

To 5 ml of the solution prepared for testing under paragraph 7.2, add 1 ml of concentrated hydrochloric acid (R), one drop of 2 pp 100 potassium permanganate (R) and 2 ml of 5 pp 100 potassium thiocyanate solution (R).

If a red coloring appears, it should be less intense than that of a control prepared with 2.5 ml of an iron(III) solution in a concentration of 0.01 g of iron per liter (R), 2.5 ml of water and the same quantities of the same reagents. (Iron content should be less than 50 mg/kg).

The proportion of iron may also be quantified by atomic absorption spectrometry, using the technique detailed in the Compendium.

7.7. Lead

Use the quantitative analysis technique detailed in the Compendium on the solution prepared for testing under paragraph 7.2. (Lead content should be less than 5 mg/kg.)

7.8. Mercury

Test for mercury concentration in the solution prepared for testing (7.2), using the method explained in the annex. (Mercury content should be less than 1 mg/kg.)

7.9. Arsenic

Using the method indicated in the Annex, test for arsenic concentration in the test solution prepared in accordance with paragraph 2. (Arsenic content should be less than 3 mg/kg.)

7.10. Quantitative Analysis of Ammonia

Dilute the test solution prepared under paragraph 7.2 to one-tenth strength, then place 10 ml of this dilute solution (0.10 g of ammonium sulfate) in a steam distillation device (described in the Annex). Add 20 ml of 30% sodium hydroxide (R) and distill 100 ml. Quantitatively analyze the distilled ammonia using 0.1 M hydrochloric acid. Let n be the number of milliliters used:

100 g of ammonium sulfate contains 1.7 n g of ammonia (NH₃).
(Ammonia concentration greater than 25 pp 100.)

7.11. Quantitative Analysis of Sulfuric Acid

Dilute the test solution prepared for testing under paragraph 7.2 to one-tenth strength, then take 25 ml of this solution and add 75 ml of water and 1 ml concentrated hydrochloric acid (R). Bring to a boil while slowly adding a small excess of barium chloride solution (R). Let the precipitate form for 30 minutes in a 100 °C water bath. Collect the precipitate, then wash, calcine in an oven at 600 °C and weigh. Let p be the weight of the barium sulfate precipitate:

100 g of ammonium sulfate contains 16.80 p g of sulfuric acid (H₂SO₄).
(Sulfuric acid content greater than 73.5 pp 100.)

8. STORAGE

Ammonium sulfate should be stored in a dry place in hermetically sealed containers, away from heat.

**ANTI-FOAMING AGENTS
(FATTY ACID MONO- AND DIGLYCERIDES)****SIN NO. 471**

OENO 5/94

OENO 17/2000

1. OBJECTIVE, ORIGIN AND SCOPE OF APPLICATION

The mixture of fatty acid glyceric mono- and diesters (with a small quantity of tri-esters), with fatty oils and acids and alimentary fats are termed mono- and diglycerides. The mixture of mono- and diglycerides used as anti-foaming agents are essentially constituted by oleic acid esters.

The product thus defined can contain small quantities of fatty acids and free glycerol. It is used under appropriate technological conditions and does not leave measurable traces in wine after filtering.

2. LABELING

The label must indicate the mono- and diglyceride content of the preparation, the storage and safety conditions, and the final date of use.

3. PROPERTIES

The product is usually found in the form of an oily liquid with a straw yellow color, a doughy product with an ivory color or a hard waxy solid with a white or off-white color. All of the forms have a pleasant odor and taste. The solid form can be found in flakes, powder or small granules.

The product used as an anti-foaming agent is liquid at normal temperatures, but can become cloudy at low temperatures.

4. SOLUBILITY

Insoluble in water.

Soluble in ethanol, chloroform and benzene.

5. IDENTIFYING CHARACTERISTICS**5.1. Hydrolysis of the Sample**

Treat 1 g of the sample by reflux using a 0.5 M potassium hydroxide solution for 1 hour. Add 15 ml of water and acidify with hydrochloric acid diluted to 30 pp 100 (v/v) (R) (approximately 4-5 ml). Oily drops or a white/yellowish white precipitate will form. Extract the fatty acids released using 5 ml hexane, separating the solvent. Repeat the extraction with 5 ml of hexane and reunite the two extracts.

Set aside the aqueous phase.

5.2. Detection of the Fatty Acids in the Hexane Extract Using Gas Phase Chromatography

For the purpose of example, use may be made of a semi-polar column, e.g., Carbowax 20M ® measuring 25m x 0.32 mm x 0.25 µm phase thickness.

5.3. Detection of Glycerol

Place 5 ml of the aqueous phase in a test tube. Add an excess amount of powdered calcium hydroxide and place the test tube in boiling water for five minutes, stirring from time to time. Cool and filter.

Place one drop of the filtrate in a test tube and add approximately 50 mg of potassium hydrogen sulfate, At the end of the test tube, place a piece of filter paper soaked in the reagent obtained by mixing extemporaneously equal volumes of a sodium nitrosopentacyanoferrate solution (R) and piperidine (F'). Heat using a small flame. A blue coloring of the reactive paper indicates the presence of acrolein.

The color turns red by adding 1M sodium hydroxide solution.

6. TESTS**6.1. Drying Loss at 100 °C**

Weigh exactly a quantity of about 5 g of the product to be analyzed in a glass crystallizing dish with a diameter of 70 mm, which has been preliminarily dried in an oven, cooled in a desiccator and calibrated. Place the crystallizing dish with the fatty material into a 103 °C oven and maintain this temperature for 30 minutes. Remove the crystallizing dish, let cool in the desiccator, then weigh. Place the sample in the oven again for 30 minutes. Weigh it again after cooling. Drying loss in the oven is completed when weight loss does not exceed 0.05% per half-hour of heating.

Drying loss at 100 °C should be less than 2 pp 100.

6.2. Sulfur Ash

Sulfur ash is quantified as indicated in the Annex using a test sample of 5 g. The sulfur ash should weigh less than 0.2 g/kg.

6.3. Arsenic

Determined as indicated in the Annex using a test sample of 5 g. The arsenic should weigh less than 3 mg/kg.

6.4. Heavy metals

Test for heavy metals either:

- After mineralization at 450 ± 5 °C of the residue left by the drying loss test. Take up the ash using 1 ml of diluted hydrochloric acid (R) and one drop of concentrated nitric acid (R) while heating in a 100 °C water bath to activate dissolution, then decant in a 25 ml volumetric flask, washing the cap with distilled water. Fill up to gauge line.

Draw off a volume of v ml of solution corresponding to 2 g of the sample to be analyzed and proceed with the test for heavy metals as indicated in the Annex.

- or, after liquid mineralization of an sample weighed with precision to about 5 g using concentrated nitric acid (R), Perhydrol and a microwave digester to accelerate the operation.

Decant the liquid obtained in a 25 ml volumetric flask and fill to the line with the wash water. Continue as indicated in the heavy metal tests.

Heavy metal content, expressed in terms of lead, should be less than 10 mg/kg.

6.5. Lead

Using the technique set forth in the Compendium, determine the quantity of lead in one of the two aforementioned preparations (6.4). The lead content should be less than 5 mg/kg.

6.6. Mercury

Using the technique described in the annex, determine the quantity of lead in one of the two aforementioned preparations (6.4). The lead content should be less than 1 mg/kg.

6.7. Cadmium

Using the technique detailed in the annex, determine the quantity of cadmium in one of the two aforementioned preparations (6.4). The lead content should be less than 1 mg/kg.

6.8. Free Fatty Acids

Prepare 125 ml of a mixture of equal volumes of isopropyl alcohol and toluene. Add 2 ml of 1 pp 100 phenolphthalein solution (m/v) in isopropyl alcohol and neutralize using an alkaline solution until a persistent but weak pink coloring appears.

Weigh with precision an amount of approximately 5 g of the sample to be analyzed in a 500 ml conical flask. Add the neutralized solvent mixture and dissolve the test sample, by heating if necessary, while

stirring vigorously. Pour the 0.1 M potassium hydroxide solution until a pink color identical to that obtained during the solvent neutralization process is obtained. Let n be the volume in ml poured:

Fatty acid content expressed in g of oleic acid pp 100 (m/m):

$2.8n$ / test sample in g

The fatty acid content in terms of oleic acid should be less than 3 pp 100 (m/m).

6.9. Soaps

Weigh precisely about 10 g of the product to be analyzed in a 250 ml conical flask. Add a mixture of 60 ml of acetone and 0.15 ml of 0.5 pp 100 (m/v) bromophenol blue solution in 95% alcohol by volume which has first been neutralized with a 0.1 M hydrochloric acid solution or a 0.1 M sodium hydroxide solution. Gently heat in a 70 °C water bath and titrate with a 0.1 M hydrochloric acid solution until the blue color disappears. Let sit for 20 minutes. Heat until the precipitate redissolves and, if the blue color reappears, continue titration.

1 ml 0.1 M hydrochloric acid solution corresponds to 0.0304 g of sodium oleate ($\text{NaC}_{18}\text{H}_{33}\text{O}_2$).

Soap content expressed in g of sodium oleate pp 100 (m/m):

$3.04n$ / test sample in g

Soap content expressed in g of sodium oleate should be less than 6 pp 100 (m/m).

6.10. Monoglycerides

6.10.1 Sample preparation

If the sample is in solid form, melt it by heating it to its melting point at a temperature of less than 10 °C. Liquid samples which are cloudy or have particles in them should also be heated. Mix vigorously.

6.10.2 Method

Weigh precisely a test sample, Q , of approximately 1 g to be analyzed in a 100 ml cylindrical flask. Dissolve using 25 ml of chloroform. Transfer this solution to a decanting glass. Wash the cylindrical flask with 25 ml of chloroform, then with 25 ml of water and add these liquids to the contents of the decanting glass.

Seal the decanting glass hermetically. Stir for 30-60 seconds. Let the two phases separate out (add 1-2 ml of crystallizable acetic acid (R) to break the emulsion). Collect the aqueous phase in a 500 ml conical flask with an emery stopper. Extract the chloroform phase remaining in the decanting glass twice with 25 ml of water. Separate the aqueous phase and place it in the 500 ml conical flask. These aqueous extracts will be used for the free glycerol analysis.

Transfer the chloroform from the decanting glass to a 500 ml conical flask with an emery stopper. Add 50 ml of periodic acetic acid solution (R) while stirring.

In the two other 500 ml conical flasks with emery stoppers to be used as "blanks", place 50 ml of chloroform and 10 ml of water. Add 50 ml of periodic acetic acid solution (R) while stirring to each of the two flasks. Let the three flasks sit at least 30 minutes, but no more than 90 minutes.

While gently stirring, add 20 ml of potassium iodide solution (R) to each of these containers. Let sit at least 1 minute but no more than 5 minutes before volumetric analysis.

Add 100 ml water and titrate with a 0.05 M sodium thiosulfate solution using a magnetic stirrer until the brown color disappears from the aqueous phase. Add 2 ml of starch solution (R) and continue to add the reagent until the iodine disappears from the chloroform layer and the blue color disappears from the aqueous phase.

6.10.3 Calculate the percentage of monoglycerides using the formula:

$$(B-S) \cdot M \cdot 17.927 / P$$

B is the average volume in ml of the sodium thiosulfate solution used for analysis of the "blanks" containing chloroform.

S is the amount of sodium thiosulfate solution in ml used to titrate the sample.

M is the exact molarity of the sodium thiosulfate solution.

P is the weight of the sample to be analyzed in the volume of chloroform used for the analysis.

17.927 is the molar mass of glycerol monostearate, divided by 20.

The monoglyceride content expressed in terms of glycerol monostearate should be greater than 30 pp 100 (m/m).

6.11. Free glycerol

Add 50 ml of periodic acetic acid solution (R) to the aqueous extracts obtained during the monoglyceride-analysis process. Simultaneously prepare a "blank" by adding to 75 ml of water in a 500 ml conical flask 50 ml of periodic acetic acid solution (R). Continue the determination process as indicated in the method described for monoglycerides.

Calculate the percentage of glycerol using the following formula:

$$(b-S)M \cdot 2.30 / Q$$

b is the volume in ml of sodium thiosulfate solution used in the quantitative analysis the "blank" containing 75 ml of water

S is the volume in ml of sodium thiosulfate solution used in the quantitative analysis of the aqueous extracts

M is the molarity of the sodium thiosulfate solution.

Q is the weight of the first sample to to be analyzed (see monoglyceride determination).

Glycerol content should be less than 7 pp 100 (m/m).

N.B. : Glycerol can also be disclosed and identified by high performance liquid chromatography (HPLC) (5.3).

7. STORAGE

Anti-foaming agents should be kept in completely water-tight containers and away from heat.

ARGON
Ar = 40.0
N° SIN: 938
N°CAS = 7440-37-1
OENO 31/2004

1. OBJECT, ORIGIN AND FIELD OF APPLICATION

Neutral gas, used for operations of inerting or degassing, it is used in a mixture of nitrogen and/or of carbon dioxide.

2. LABELLING

The label must mention the nature of the gas and refer to its composition and purity. The safety conditions must also be indicated on the packages.

3. CHARACTERISTICS

Colourless and odourless gas without flavour. Non flammable, it does not support combustion.

The weight of a litre of argon under the pressure of 760 mm of mercury is 1.784 g at 0°C. A volume of water dissolves 0.0336 volume of argon at 20°C.

4. TEST TRIALS

The global purity of the argon used in oenology must not be less than 99% of argon in volume.

Before any measurement it is advisable to allow any gas to escape for a few minutes in order to purge the piping.

4.1 Chromatographic dosage

The search and determination of gases: Nitrogen, carbon monoxide (less than 10 µl/l), oxygen (10 ml/l), hydrogen, carbon dioxide (less than 300 µl/l), etc., are quickly obtained by chromatography in gaseous phase according to the method in chapter II of the International Oenological Codex.

The total surface area of hydrogen chromatographic peaks, of oxygen and nitrogen must not exceed 1% of gas surfaces to be examined

The following chemical methods can also be used for oxygen.

4.2 Oxygen dosage by chemical method

Preparation of the flask for searching oxygen:

Introduce in a 24 ml flask about two fragments of copper turnings of 2 cm, 16 ml of ammoniac solution of copper sulphate (R), then 2 ml of hydrazine dihydrochloride solution (R).

Seal the flask with a rubber stopper that is easy to pierce with a needle for hypodermic injections. Crimp the neck with a metallic capsule. Then cover the capsule with wax in order to ensure perfect water tightness. Shake the flask and allow to stand away from light until complete discolouration is obtained after about eight days.

Conduct of the test trial:

Pierce the flask's stopper to search for oxygen with a needle of 8/10 millimetre for hypodermic injection (take care so as not to plunge it into the liquid) that then will be used for evacuating the gas after bubbling. Then introduce a second needle of the same diameter releasing the gas and plunging it into the liquid. After a minute of bubbling, a noticeable colouration should not be observed. In the presence of oxygen, the liquid quickly becomes blue and the colour darkens with time.

4. PACKAGING

The argon is supplied in highly resistant steel cylinders painted in white with needle valves. The resistance of these cylinders must be checked periodically.

ASCORBIC ACID
2,3-didehydro-L-threohexano-4-lactone
Acidum ascorbicum
L-Ascorbic Acid
C₆H₈O₆ = 176.1
SIN NO. 300
OENO 18/2000
OENO 4/2007

1. OBJECTIVE, ORIGIN AND SCOPE OF APPLICATION

Ascorbic acid is the enolic form of 3-oxo-L-gulofuranolactone (2,3-didehydro-L-threohexano-4-lactone).

This product falls into the category of antioxidants and is used as a reducing agent used to prevent oxidation.

Its use is subject to statutory regulations regarding limits.

2. LABELING

The concentration of this product should be indicated on the label, including cases in which it is used in mixtures, as should the safety and storage conditions.

3. PROPERTIES

Odorless white or very pale yellow crystalline powder with an acidic flavor. Aqueous solutions rapidly decay in air and light and have a maximum stability at pH 5.4. Melting point in a capillary tube: approximately 190 °C with decomposition.

Ascorbic acid in aqueous solution has a pH of less than or equal to 3.

4. SOLUBILITY

Water at 20 °C	290 g/l
Alcohol, 95% by vol.	320 g/l
Methanol	125 g/l
Acetone	soluble
Benzene, chloroform, ethyl ether, petroleum ether:	insoluble

5. ROTATORY POWER

In a 10 pp 100 (m/v) aqueous solution, ascorbic acid has a specific rotatory power

$$[\alpha]_{20^{\circ}\text{C}}^{\text{D}}$$

is between + 20.5 and +21.5°.

6. ABSORPTION IN ULTRAVIOLET LIGHT

Ascorbic acid in alcohol solutions in a concentration of 10 mg/l exhibits an absorption spectrum with a maximum of approximately 244 nm.

The solution has a specific extinction of:

$$E \begin{matrix} 1 \text{ percent} \\ 1 \text{ cm} \end{matrix} \text{ approximately } 560$$

7. IDENTIFYING CHARACTERISTICS

7.1. Preparation of the Solution for Testing

Dissolve 5 g ascorbic acid in water and fill to 100 ml using the same solvent.

7.2. Add 0.5 g monosodium carbonate to 2 ml of the solution prepared for testing (Par. 7.1).

7.3. Add several drops nitric acid diluted to 10 pp 100 (R) and several drops silver nitrate in a concentration of 1 pp 100 (R) to 1 ml of the solution prepared for tests (Par. 7.1). A gray precipitate will form.

7.4. To 1 ml of the solution prepared for testing (Par. 7.1) add one drop of recently prepared sodium nitrohexacyanoferrate (III) $\text{Na}_2[\text{Fe}(\text{CN})_5\text{NO}] \cdot 2\text{H}_2\text{O}$ (sodium pentacyanonitrosylferrate) in a concentration of 5 pp 100 (m.v), and 2 ml of 10 pp 100 diluted sodium hydroxide solution (R). Then, add 0.6-0.7 ml of concentrated hydrochloric acid (R) and stir. The yellow color will turn to blue.

7.5. Add drop by drop 2 ml of 2,6-dichlorophenolindophenol solution (R) to the solution prepared for testing (Par. 7.1). It will instantly become decolorized.

8. TESTS

8.1. Sulfur Ash

As determined in 1.0 g ascorbic acid, the proportion of sulfur ash should not be greater than 1 g/kg.

8.2. Appearance of the Solution

The solution prepared for tests under paragraph 7.1 should be clear and colorless.

8.3. Determining pH

The pH of the solution prepared for tests under paragraph 7.1 should be between 2.4 and 2.8.

8.4. Heavy metals

10 ml of the solution prepared for tests under paragraph 7.1 should meet the heavy metal limit requirements described in the annex. (The heavy metal concentration expressed in terms of lead should be less than 10 mg/kg).

8.5. Lead

Use the technique detailed in the Compendium to analyze the solution prepared for tests (Par. 7.1). (Lead concentration should be less than 2 mg/kg).

8.6. Mercury

Use the technique described in the annex to analyze the solution prepared for tests (Par. 7.1). (Mercury concentration should be less than 1 mg/kg.)

8.7. Arsenic

Using the method indicated in the Annex, test for arsenic in the test solution prepared in accordance with paragraph 7.1. (Arsenic concentration should be less than 3 mg/kg).

8.8. Iron

Implement the atomic absorption technique described in the Compendium to analyze the solution prepared for tests (Par. 7.1). (Iron concentration should be less than 5 mg/kg.)

8.9. Copper

Implement the atomic absorption technique described in the Compendium to analyze the solution prepared for tests (Par. 7.1). (Copper concentration should be less than 2 mg/kg.)

8.10. Moisture

Dehydration loss after drying in a desiccator under a vacuum and in the presence of sulfuric acid for 24 hours must be less than 0.4%.

8.11. Quantitative Analysis

In 80 ml of recently boiled and cooled water to which 10 ml of sulfuric acid diluted to 10 pp 100 (R) has been added, dissolve a test

sample weighed precisely at about 0.20 g. Add 1 ml of starch (R) and titrate using 0.05 M iodine until a persistent blue coloration appears.

1 ml of 0.05 M iodine corresponds to 8.81 mg ascorbic acid.

The product should contain at least 99 pp 100 ascorbic acid.

9. STORAGE

Ascorbic acid should be stored in tightly sealed non-metal containers in a dark place. Aqueous solutions decay rapidly in air and light.

ISOASCORBIC ACID

Isoascorbic acid, or D-ascorbic acid or erythorbic acid has the same antioxidant power as ascorbic acid and can be used for the same oenological purpose.

This acid exhibits the same appearance and the same solubility properties as ascorbic acid.

It is, optically, the reverse of ascorbic acid and has, under the same conditions, a specific rotatory power of:

$$[\alpha]_{\text{D}}^{20} \text{ between } -20 \text{ and } -21.5^{\circ}$$

With the exception of rotatory power, this acid should exhibit the same properties as ascorbic acid, respond in the same way to the identifying reactions, pass the same tests and responds to the same quantitative analysis.

Note: The vitamin C efficacy of isoascorbic acid is approximately 1/20 of that of ascorbic acid.

Note : There is a preliminary draft resolution calling for registration of this product in the International Code of Oenological Practices.

LACTIC ACID BACTERIA

OENO 3/89

OENO 15/2003

OIV/OENO 328/2009

OIV-OENO 494-2012

1. OBJECT, ORIGIN AND FIELD OF APPLICATION

Lactic acid bacteria are used in oenology to perform malolactic fermentation. The lactic acid bacteria must belong to the *Oenococcus*, *Leuconostoc*, *Lactobacillus* and *Pediococcus* genus and must be isolated from grapes, musts, wine or have been derived from these bacteria.

The use of genetically modified bacteria will be governed by the currently applicable legislation.

The strains of lactic acid bacteria must be kept under conditions which most favour their genetic stability.

Lactic acid bacteria used in oenology must transform the malic acid in must and wine into lactic acid and carbon dioxide. This should produce biogenic amines in the smallest possible quantities, and must not produce an off taste.

2. LABELLING

The following information must be indicated on the label:

- The genus name and specie(s) in addition to the reference(s) of the strain(s) in the case that there is a registration body.
- Selecting body
- Operating instructions method and possible reactivation additives recommended by the manufacturer.
- The minimum number of viable cells per gram of preparation that is guaranteed by the manufacturer,
- The manufacturing batch number, in addition to the expiration date and storage conditions with a storage temperature recommended by the manufacturer.
- Where relevant, the indication that lactic acid bacteria were obtained by genetic modifications and their modified character(s).
- The additives.

3. CHARACTERISTICS

Lactic acid bacteria are marketed in liquid, frozen or powder form obtained by lyophilisation or drying, in pure culture or in association with pure cultures.

4. TEST TRIALS

4.1 – Humidity for lyophilised or dried bacteria

Measured by the weight loss of 5 g of the product, dried at 105 °C until constant weight (about 3 hours).

Maximum content should not exceed 8 %.

4.2 - Lead

Proceed with the determination according to the method in chapter II of the International Oenological Codex.

Content should be less than 2 mg/kg of dry matter.

4.3 - Mercury

Proceed with the determination according to the method in chapter II of the International Oenological Codex.

Content should be less than 1 mg/kg of dry matter.

4.4 - Arsenic

Proceed with the determination according to the method in chapter II of the International Oenological Codex.

Content should be less than 3 mg/kg of dry matter.

4.5 - Cadmium

Proceed with the determination according to the method in chapter II of the International Oenological Codex.

Content should be less than 1 mg/kg of dry matter.

4.6 – Viable lactic acid bacteria¹

Proceed with counting according to the method in chapter II of the International Oenological Codex.

The number should be more or equal to 10^8 CFU/ml for frozen or liquid bacteria.

The number should be more or equal to 10^{11} CFU/g for lyophilised or dried bacteria.

4.7 - Mould

Proceed with counting according to the method in chapter II of the International Oenological Codex.

The number should be less than 10^3 CFU/g.

4.8 – Contaminant acetic acid bacteria

Proceed with counting according to the methods in chapter II of the International Oenological Codex.

The number of acetic bacteria should be less than 10^3 CFU/g for frozen or liquid lactic acid bacteria or 10^4 CFU/g for lyophilised or dried lactic acid bacteria.

The sum of *Acetobacter* + *Gluconobacter* should be less than 10^3 CFU/ml for frozen or liquid lactic acid bacteria or 10^4 CFU/g for lyophilised or dried lactic acid bacteria.

4.9 – Yeasts contaminants

Proceed with counting according to the methods in chapter II of the International Oenological Codex.

The number of viable cells of total contaminant yeasts must be less than 10^3 CFU/g for lyophilised or dried lactic acid bacteria or 10^2 CFU/ml for frozen or liquid lactic acid bacteria.

¹ Except for specific bacteria intended for acidic wines (pH up to 2.85) that should be used with a pre-multiplication process (see Annex) in the must or wine, where the population cannot be less than 10^9 CFU/g.
Reference:

1) Bridier, J., O. Claisse, M. Coton, E. Coton and A. Lonvaud-Funel (2010). "Evidence of distinct populations and specific subpopulations within the species *Oenococcus oeni*." Appl Environ Microbiol **76**(23): 7754-7764.

4.10 - Salmonella

Proceed with counting according to the method in chapter II of the International Oenological Codex.

Absence should be checked on a 25 g sample.

4.11 - *Pseudomonas aeruginosa*²**4.12 - *Escherichia coli***

Proceed with counting according to the method in chapter II of the International Oenological Codex using a selective differential medium for *Escherichia coli*. MET in the annex. A lactic acid bacteria stock suspension is carried out in a tryptone salt solution using 1 g of lactic acid bacteria for 10 ml of solution (total volume). 2 ml of stock solution is transferred to each dish using 5 different dishes. Absence should be checked on 1 g sample.

4.13 - *Staphylococci*

Proceed with counting according to the method in chapter II of the International Oenological Codex. The presence of staphylococci is evaluated by an enrichment culture in a liquid Giolitti and Cantoni medium followed by a confirmation on a solid Baird Parker medium in the annex.

A lactic acid bacteria stock suspension is carried out in a salt tryptone solution using 1 g of lactic acid bacteria for 10 ml of solution (total volume). 10 ml of stock suspension is used to inoculate a Giolitti and Cantoni medium to Tween 80 double concentration. Cultures are incubated 48 hours at 37 °C.

In the case that the Giolitti and Cantoni medium gives positive results, the presence of *Staphylococci* is confirmed by isolation on a solid Baird Parker medium. A positive culture medium loop is used to inoculate solid BP mediums to obtain isolated colonies.

Absence should be checked on 1 g sample.

4.14 - Coliforms

Proceed with counting according to the method in chapter II of the International Oenological Codex using a selective differential medium for coliforms, desoxycholate gelose in the annex. A lactic acid bacteria stock suspension is carried out in a salt tryptone solution using 1 g of lactic

² Point to be studied at a later date by the expert group "Microbiology".

acid bacteria for 10 ml of solution (total volume). 2 ml of stock solution are transferred is each dish using 5 different dishes.

The number of coliforms should be less than 10^2 CFU/g.

5. ADDITIVES

They must be in conformity with regulations in force.

6. STORAGE CONDITIONS

Always refer to manufacturer's recommendations.

Appendix

Preparation of a leaven "pied de cuve malo"

to inoculate 100hL of wine or any volume
from the values in brackets in %,
the quantities of powder are expressed in g/L

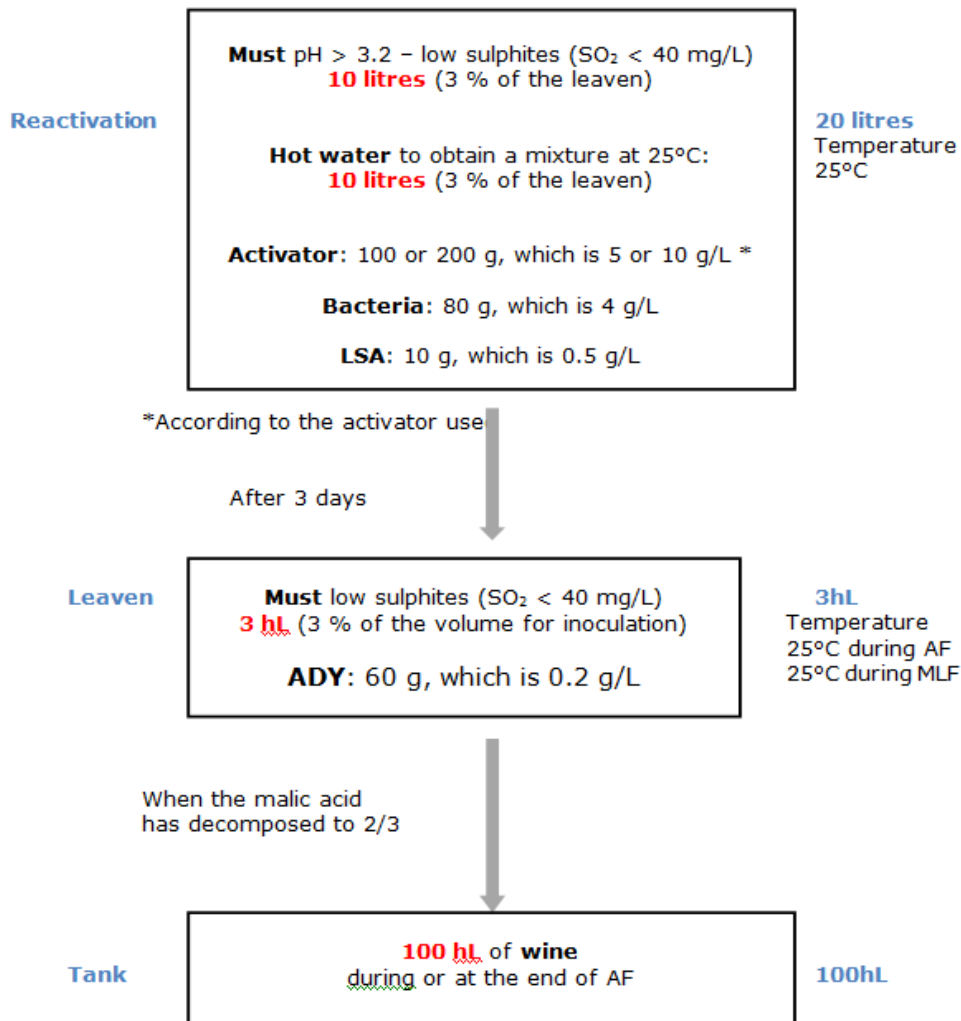

BENTONITES

Bentonita

N° SIN: 558

OENO 11/2003

OENO 441-2011

1. OBJECT, ORIGIN AND FIELD OF APPLICATION

Bentonites are hydrous aluminium silicates belonging to the montmorillonite group. The brute formula is:

$Si_4 (Al (2-x) R_x) (O_{10}, H_2O)(Ce_x, nH_2O)$ or $Si_4(Al(2-x)R_x)(H_2O)_n$
where:

-R = Mg, Fe, M, Zn, Ni

-Ce (exchangeable cations) = Ca, Na, Mg.

Bentonites are used for clarification operations or protein stabilisation in musts and wine. Bentonites fix to certain unstable proteins which allows them to be eliminated.

Bentonites are capable of fixing coloured matter.

2. LABELLING

The nature of the bentonite (natural sodium, calcium, and activated calcium), batch number and the optimal expiration date for activated bentonites will be indicated on the label. The mention of risks and safety concerning the presence of crystalline silica should also be indicated.

2.1 Natural Bentonites:

Depending on the nature of the of exchangeable cations present, there are 2 naturally occurring types of bentonite:

- **Sodium bentonite**, it swells and absorbs readily where sodium is the major exchangeable cation.
- **Calcium bentonite**, where calcium is the major exchangeable cation, it is lower swelling and lower absorbent than sodium bentonites.

These two types of bentonites are simply grinded before their commercialisation after possibly being dried at 80°C to 90°C.

2.2 Activated bentonites:

In order to improve the adsorption properties of calcium bentonites, they are most often activated by sodium carbonate, then dried and grinded. This results in activated calcium bentonites with properties equal or superior to sodium bentonites.

The properties of these bentonites thus activated or permuted are less stable in time (3 to 18 months) and depend on the activation of magnesium, calcium, and sodium levels.

These different types of bentonites are in the form of powder, spherical or cylindrical granules. Colour can vary from white for the purest products to grey, beige or green for others.

3. TEST TRIALS

3.1 Odour

Bentonite should not have any undesirable odour (e.g. no mould) and should not change the taste of wine.

3.2 pH level

Shake 5g of bentonite with 100 ml of distilled water for 5 minutes. Allow to stand for 1 hour. Measure the pH level of the supernatant liquid. Natural calcium bentonites have a neutral pH (level around 6.5 to 8.5) whereas activated calcium bentonites have a much more alkaline pH (level around 8.5 to 10.0). Natural sodium bentonites have a wider range of pH (level around 4.7 to 10.0).

3.3 Loss during desiccation

The desiccation of 5 g of bentonite at 105°C during 4 hours causes a weight loss of 5% to 15% of the initial weight (often around 10%).

3.4 Preparation of the test trial solution

Weigh **p** g of bentonite containing 10 g of anhydrous bentonite.

In a 500 ml flask with a large opening which can be hermetically sealed, add 100 ml of tartaric acid solution to 5 g per litre until the solution has a pH level of 3 (R). Sprinkle the bentonite trial sample in the constantly shaken solution (for example using a magnetic stirrer) and a funnel. After this addition, shake vigorously for 5 minutes. Allow to stand for 24 to 48 hours. Decant, centrifuge or filter if necessary to obtain at least 100 ml of clear liquid.

All the following set limits for bentonite are for the weight of dried bentonite.

3.5 Montmorillonite content

Minimum rate:

Manufacturer indicates that the content should not be under 80% by x-ray diffraction analysis.

3.6 Different forms of free silica content

Crystal silica content must be less than 3% (quartz N° CAS 14080-60-7, cristobalite N° CAS 14464-46-1).

Particle holdings under 10 microns must be less than 10%.

Respirable crystal silica content must be under 0.3%.

These standards must be written on the security form supplied by the manufacturer.

3.7 Lead

In the test trial solution (3.4) determine the lead content using the method described in Chapter II.

Lead content must be less than 5 mg/kg.

3.8 Mercury

Determine the mercury content according to the method described in Chapter II with the test trial solution (3.4).

Mercury content should be less than 1 mg/kg.

3.9 Arsenic

Determine the arsenic content of 5 ml of test trial solution (3.4) according to the method in Chapter II.

Soluble arsenic content should be less than 2 mg/kg.

3.10 Iron

Add 12.5 ml of water, 1 ml concentrated hydrochloric acid (R) and 2 ml of potassium thiocyanate at 5% (R) to 5 ml of the test trial solution (3.4). The red coloration should be lighter than what is obtained when using 2.5 ml citric acid at 5% at pH 3 (R), 1 ml concentrated hydrochloric acid (R), 15 ml of iron salt solution (III) at 0.010 g of iron per litre (R) and 2 ml of potassium thiocyanate solution at 5% (R).

Iron content should be less than 600 mg/kg).

Iron can also be determined by atomic absorption spectrometry according to the method in Chapter II.

3.11 Aluminium

On the test trial solution (3.4), find extractable aluminium according to the method described in Chapter II.

Extractable aluminium content should be less than 2.5 g/kg.

3.12 Calcium and magnesium

On the test trial solution (3.4), determine calcium and magnesium using the methods outlined in the Compendium of International Methods of Analysis of Wine and Musts.

Calcium and soluble magnesium combined should be less than 100 meq for 100 g.

3.13 Sodium

On the test trial solution (3.4), determine sodium using the method outlined in the Compendium of International Methods of Analysis of Wine and Musts.

Soluble sodium content should be less than 10 g/kg for natural bentonites and less than or equal to 35 g/kg for activated bentonites.

3.14 Presence of large particles

Put 1 litre of water in a 1.5 litre long stem glass. Slowly add while shaking the liquid, a quantity of bentonite corresponding to 50 g of dried bentonite. Shake vigorously 2 to 3 minutes and allow to

stand for 24 hours. Shake 2 to 3 minutes and allow to stand for 2 minutes. Using a siphon, take off 9/10 of the cloudy liquid exceeding 100 ml and leave the deposits at the bottom of the glass. Add 900 ml of water. Shake 1 minute. Allow to stand for 2 minutes and repeat to obtain 5 washings. Remove the deposit and put in a capsule. Dry and weigh. The residue must be less than 8 g for 100 g.

3.15 De-acidification tests trials

Weigh (**p**) of bentonite containing 0.2 g of dried bentonite. Put this in a 125 ml flask containing 50 ml of citric acid 0.033 M solution (R). Shake vigorously for 5 minutes and allow to stand for 30 minutes. Either filter or centrifuge. Take 10 ml of filtrate and titrate with an acid solution of 0.1 M of sodium hydroxide with a drop of phenolphthalein solution (R), that is **n** ml the volume poured to obtain a colour change in the indicator:

250 (10 - **n**) is the number of milliequivalent of acids fixed or neutralised for 100 g of bentonite.

The maximum limit is 2.5 eq/kg.

3.16 Rate of swelling

Swelling indicator: specific test is necessary.

2 g of bentonite is strewn over 100 ml of demineralised water and 100 ml of wine in a graduated test tube cylinder. After 24 hours, weigh the volume of bentonite. This will be expressed in ml/g of dried product.

3.17 Protein adsorption test trial (for bentonite to go through deproteinisation)

3.17.1- Preparation of test trial solution:

Mix 5 g of egg white with a sufficient amount of citric acid solution of 5 g per litre (pH=3) to make 1 litre. Filter. Determine total nitrogen on 100 ml of this solution by using the procedure described in Chapter II. This solution contains approximately 90 mg of total nitrogen for 575 mg of proteins per litre.

3.17.2 - For each test trial using 100 ml of this solution, mix increasingly larger doses of bentonites prepared in a 5% suspension in order to process doses of 0.1 to 0.8 g/l. Shake

vigorously and maintain at 15°C–20 °C for 6 hours. Centrifuge and proceed with determinations of nitrogen or residual proteins. A de-proteinising bentonite should eliminate at least 50% of the proteins in a synthetic solution with a 0.4 g/l dose.

3.18 Determining the specific adsorption surface (or the adsorption indicator for methylene blue)

See method described in annex.

The accepted limit should be 300 mg/100g.

4. STORAGE

Bentonites must be stored in a ventilated area in watertight containers away from volatile objects that they could adsorb.

ANNEX
DETERMINATION OF THE SPECIFIC SURFACE OF ADSORPTION
OF BENTONITE

1. GENERAL INFORMATION**1.1 Aim of the test trial**

This test trial enables to measure the capacity of bentonite to adsorb methylene blue.

Clays, organic matters, and iron hydroxide preferentially adsorb methylene blue. This capacity takes into account the activity on the surface of these elements. We call, "blue value" of bentonites, the quantity expressed in grams of methylene blue adsorbed per 100 g of bentonites.

1.2 Principle of the test trial

Elemental doses of a methylene blue solution are injected successively into an aqueous solution containing the trial sample. The adsorption of blue is checked after each addition by making a spot on a paper filter (spot test, see paragraph 5).

For a simple conformity check, the specified quantity of blue is injected once.

2. EQUIPMENT AND REAGENT

2.1 A 25 ml burette graduated 1/10 ml.

2.2 Paper filter: quantitative and without ashes (< 0.010); weight: 95 g/m²; thickness: 0.20 mm; filtration speed 75; retention: 8 micrometers.

2.3 A glass rod: 300 mm length; 8 mm diameter.

2.4 A magnetic stirrer and magnetic stirring bar.

2.5 Methylene blue of medicinal quality at 10g/l \pm 0.1 g/l.

The maximum duration for using the solution is one month. The solution must be stored away from light.

2.6 Demineralised or distilled water.

3. PREPARATION OF TEST TRIAL SAMPLES

Add 10 g of bentonite in 200 ml of distilled water, allow to swell for 2 hours, then homogenise by shaking.

4. CARRYING OUT TEST TRIAL**4.1 Definition of spot test**

After each addition of blue (see paragraph 5.2), this test involves taking a drop of suspension that is placed on a paper filter using a glass rod. The spot that is formed is composed of a central deposit of matter, blue in colour surrounded by a humid colourless area.

The drop must be such that the diameter of the deposit is between 8 and 12 mm.

The test is positive if a persistent light blue ring appears around the middle deposit in the humid zone. The test is negative if the ring is colourless.

4.2 Determination

Using a burette, pour 2 ml of blue solution in a container with 200 ml of suspension of bentonite maintained in agitation. After 2 minutes, add 1 ml of blue solution. This addition is followed by the spot test on filter paper.

Allow the asorption of blue to occur which is not instantaneous. Meanwhile tests should be conducted minute by minute.

If the light blue ring disappears at the fifth spot, proceed with elemental additions of 0.2 ml of blue and then 0.1 ml.

Each addition is followed by tests conducted minute by minute.

Renew these operations until the test remains positive for 5 consecutive minutes: the determination is considered as ended.

That is V ml poured.

5. EXPRESSION OF RESULTS**5.1 Blue value**

The blue value expressed in grams of blue for 100 g of bentonite is shown in the following formula:

$$V \times 10$$

V is the value of blue methylene poured in ml.

5.2 Conformity check compared to a given specification

The specification is expressed in blue value for 100 g of bentonite, or s of this value.

The volume of blue solution to be added in one time to the preparation (3) is:

$$V = \frac{s}{10}$$

The spot test is done after eight minutes of shaking. If it is negative, the bentonite complies with the specification.

BETA-GLUCANASES from *Trichoderma Sp*
(E.C. 3-2-1-58)
(C.A.S. No. 9073-49-8)
Glucan 1,3-beta-glucosidase
(exo-1,3-beta-glucosidase; beta-1,3-glucan exo-hydrolase; exo-
1,3-beta-glucanase; endo-1,3-beta-glucanase)
and glucan 1,6-beta-glucosidase
OENO 27/2004

GENERAL SPECIFICATIONS

The specifications must comply with general specifications for enzymatic preparations that appear in the International Oenological Codex.

1. OBJECT, ORIGIN AND FIELD OF APPLICATION

The degradation of beta-glucans present in wines, in particular those from grapes affected by *Botrytis cinerea* or yeast glucans. These molecules of a very high molecular weight hydrolyse the beta-1,3 and beta-1,6 bonds of 1,3 (1,6)-beta-D-glucans with glucose production.

Secondary activities: hemicellulases, cellulases.

The beta-1,3-D-glucanases are produced from *Trichoderma harzianum* and/or *Trichoderma reesei*

The preparation of the enzyme is without any harmful consequences as is production and purification.

Beta-glucanases do not contain any substances, micro-organisms nor collateral enzymatic activities that can:

- be harmful to health,
- be harmful to the quality of the products treated,
- lead to the formation of undesirable products or flavour problems.

There are regulatory limits for the use of beta-glucanases in wine.

2. LABELLING

The concentration of the product must be indicated on the label, as well as the safety conditions, storage conditions and the expiry date.

3. CHARACTERISTICS

In general, it is greyish to light brown amorphous powder or light brown to dark brown liquids or granules.

4. SOLUBILITY

Soluble in water and practically insoluble in ethanol.

5. ENZYMATIC ACTIVITY

Activity is the quantity of enzyme necessary for liberating in standardised conditions (see activity measured according to a method to be described), a quantity of reducing sugars corresponding to 1 μ mole of glucose per minute.

Remark: the enzyme produced according to paragraph 6 simultaneously has beta-1,3-glucanase and beta-1,6-glucanase activities which gives it the sought oenological properties.

6. SOURCE OF ENZYME AND PRODUCTION MEANS

The beta (-1,3-1,6) glucanases are produced by submerged culture of a selected non pathogenic, non toxic strain of *Trichoderma harzianum* and/or *Ressei* that is not genetically modified, in pure culture.

7. DILUENTS, PRESERVATIVES AND ADDITIVES

The preparation of beta-glucanase is generally in the form of granules. These products are prepared with food diluents or food additives such as maltodextrin, sodium citrate, citric acid, starch or glucose.

8. TEST TRIALS

8.1 Loss at desiccation: Less than 10%. (does not apply to liquid preparations)

8.2 Ashes/Sulphuric ashes

Determine the sulphuric cinders according to the method in Chapter II of the International Oenological Codex.

The rate of sulphuric ashes of beta-glucanases should not be more than 2% of dry matter.

8.3 Preparation of the test solution

Dissolve 5 g of beta-glucanases in 100 ml of water.

8.4 Heavy metals

Add 2 ml of buffer solution pH 3.5 (R) and 1.2 ml of thioacetamide reagent (R) to 10 ml of the test trial solution (8.3). No precipitate should form. If a brown colouration appears, it should be

lighter than the control prepared as indicated in Chapter II of the International Oenological Codex.

The heavy metal content expressed in lead should be less than 30 mg/kg.

8.5 Arsenic

In 2 ml of test trial solution (8.3), search by the method indicated in

Chapter II of the International Oenological Codex.

Arsenic content should be less than 3 mg/kg.

8.6 Lead

Using the test trial solution (8.3) determine the lead according to the method described.

Lead content should be less than 5 mg/kg.

8.7 Mercury

Using the test trial solution (8.3) determine the mercury according to the method described in Chapter II of the International Oenological Codex.

Mercury content should be less than 0.5 mg/kg.

8.8 Cadmium

Using the test trial solution (8.3) determine the cadmium according to the method described in chapter II of the International Oenological Codex.

Cadmium content should be less than 0.5 mg/kg.

8.9 Biological contaminants

Total microorganisms	less than 5 10 ⁴ CFU/g of preparation
Total bacteria	less than 10 ³ CFU/g of preparation
Total coliforms	less than 30 CFU/g of preparation
<i>Escherichia coli</i>	absence checked on a 25 g sample
<i>St. aureus</i> *	absence checked on a 1 g sample
Salmonella	absence checked on a 25 g sample
Sulfitoreducing anaerobia	less than 30 CFU/g of preparation
Yeasts	maximum content 10 ² CFU/g of preparation
Total lactic bacteria	absence checked on a 10 g sample
Acetic bacteria	maximum content 10 ² CFU/ g of preparation
Moulds	maximum content 10 ² CFU/g of preparation

Antibiotic activity*
Mycotoxins*

not detectable
not detectable

9. STORAGE

In a solid form, the preparation can be stored for several years and in a liquid form for several months at a low temperature (+5°C).

* Method to be defined by the Sub-commission of Methods of Analysis

CALCIUM CARBONATE*Calcii carbonas***CaCO₃ = 100.1****SIN NO. 170**

OENO 20/2000

OENO 4/2007

1. OBJECTIVE, ORIGIN AND SCOPE OF APPLICATION

This product is used for deacidification. The transport of calcium ions causes salification of free tartaric acid. The use of calcium carbonate is also authorized when using the so-called "double salt" method of deacidification. It may then contain small quantities of calcium tartromalate (double salt) and/or calcium tartrate. There are regulations governing the use of this product..

2. LABELING

The label should indicate the proportion of pure calcium carbonate and the safety and storage requirements.

3. CENTESIMAL COMPOSITION

Carbon dioxide 43.97

Calcium 40.04

4. PROPERTIES

Calcium carbonate exists as a white powder with the reaction properties of carbonates. In solution in a concentration of 5 pp 100 (m/v) in dilute acetic acid (R), it yields calcium reactions.

5. SOLUBILITY

Insoluble in water

Insoluble in alcohol at 95% by vol.

Soluble with effervescence in dilute acetic acid, hydrochloric acid and nitric acid solutions

6. TESTS**6.1. Desiccation loss**

Weigh 2 g calcium carbonate in a dish. Place in an oven at 200 °C for 4 hours. Weight loss should not exceed 2 pp 100.

6.2. Substances Soluble in Water

Mix 2 g of ground calcium carbonate with 20 ml of boiled water. Filter. Collect 10 ml. The solution should be neutral. Dry evaporate. The residue should not be greater than 1 pp 100l.

6.3. Ammoniacal Ions

Place 2 g of calcium carbonate, 25 ml of distilled water and 5 ml of 30 pp 100 sodium hydroxide solution (R) in the flask of a distillation device.

Distill and collect 20 ml distillate in 40 ml 4 pp 100 boric acid (R) in the presence of methyl red (R). Two drops of 0.1 M hydrochloric acid solution should be sufficient to cause the indicator to turn color.

6.4. Barium

Dissolve 0.50 g of calcium carbonate in 10 ml of nitric acid diluted to 10 pp 100 (R). Add 10 ml of saturated calcium sulfate solution (R). The mixture should remain clear.

6.5. Preparing the Solution for Tests

Dissolve 10 g of calcium carbonate in 100 ml of 10 pp 100 dilute acetic acid (m/v) (take care as there will be effervescence due to the release of carbon dioxide).

6.6. Magnesium

Use the method described in the Compendium on the solution prepared for testing under paragraph 6.5. (Content should be less than 1 pp 100 by weight).

6.7. Iron

Use the atomic absorption spectrometry method described in the Compendium on the solution prepared under paragraph 6.5. (Iron content should be less than 300 mg/kg).

6.8. Lead

Using the technique described in the annex to quantitatively analyze the lead in the solution prepared for testing (Par. 6.5). (Lead content should be less than 2 mg/kg).

6.9. Mercury

Implement the technique described in the annex to quantitatively analyze the mercury in the solution prepared for testing (Par. 6.5). (Mercury content should be less than 1 mg/kg).

6.10. Arsenic

Using the method described in the annex, test for arsenic in the solution prepared for testing (Par. 6.5). (Arsenic content should be less than 3 mg/kg).

6.11. Sodium

In accordance with the method described in the Compendium, quantitatively determine sodium content by flame photometry in the solution prepared for testing (Par. 6.5). (Sodium content should be less than 500 mg/kg).

6.12. Quantitative Analysis

Dissolve a precisely weighed sample p of about 2 g in 50 ml of a 1 M hydrochloric acid solution. Bring to a boil. Allow to cool and titrate the excess hydrochloric acid solution using 1 M sodium hydroxide solution and methyl red (R). Let n be the amount in ml of 1 M sodium hydroxide solution used:

1 ml of 1 M hydrochloric acid corresponds to 0.05005 g calcium carbonate. Parts per 100 of calcium carbonate in the product tested:

$$(50-n) 5.005 / p$$

The wine-making product must contain a minimum of 98 pp 100 calcium carbonate.

6 STORAGE

Calcium carbonate should be stored in a dry place in hermetically sealed containers away from volatile elements it could adsorb.

POTASSIUM CARBONATE

AG 8/78-OEN;
OIV-OENO 579-2018

Potassium carbonate anhydrous (K_2CO_3 , CAS No. 584-08-7)
Potassium carbonate hydrate ($2K_2CO_3 \cdot 3H_2O$, CAS No.: 6381-79-9)

1. OBJECTIVE, ORIGIN AND SCOPE OF APPLICATION

The addition of potassium carbonate can be used to deacidify musts and wines.

2. LABELLING

The label should indicate the product's purity, lot code, date of manufacture, storage conditions and expiration date.

3. CHARACTERISTICS

Anhydrous potassium carbonate (K_2CO_3) is the potassium salt of carbonic acid and occurs as a white, odourless, hygroscopic powder. The hydrate form ($2K_2CO_3 \cdot 3H_2O$) occurs as small, white, translucent crystals or granules.

4. IDENTIFYING CHARACTERISTICS

4.1 Solubility: Very soluble in water, insoluble in ethanol (95% by vol).

4.2 Carbonate: Potassium carbonate is soluble with effervescence in dilute acetic acid or hydrochloric acid solutions, evolving a colourless gas (CO_2) that, when passed into calcium hydroxide solution, produces a white precipitate immediately.

4.3 Potassium: The presence of potassium imparts a violet colour to a non-luminous flame if not masked by the presence of small quantities of sodium.

5. TESTS

The limits are determined according to the values observed during production in line with the good manufacturing practices.

5.1. Desiccation Loss

Through the desiccation of 3 g of potassium carbonate for 4 hours at $180^\circ C$, for the anhydrous form, the loss of weight must be lower than 1%, for the hydrate form, the loss of weight must be between 10,0%

and 16,5%

5.2. Preparing the Solution for Tests

Dissolve 1 g of potassium carbonate in 20 mL water.

5.3. Substances Insoluble in Water

Filter the solution prepared for testing under Paragraph 5.2. on a membrane of cellulose ester with a diameter of the pore lower or equal to 0,5 µm, no residue can be detected.

5.4. Iron

Using the atomic absorption spectrometry technique detailed in chapter II of the *International Oenological Codex*, determine the iron content in the test solution (5.2); the content should be less than 10 mg/kg.

5.5. Lead

Using the technique set forth in chapter II of the *International Oenological Codex*, determine the lead content in the test solution (5.2); the content should be less than 5 mg/kg.

5.6. Mercury

Using the technique described in chapter II of the *International Oenological Codex*, determine the mercury content in the test solution (5.2); the content should be less than 1 mg/kg.

5.7. Arsenic

Using the technique described in chapter II of the *International Oenological Codex*, determine the arsenic content in the test solution (5.2); the content should be less than 3 mg/kg.

5.8. Sodium

Determine the sodium content in the test solution (5.2) using flame photometry described in chapter II of the *International Oenological Codex*; the content should be less than 1%.

5.9. Cadmium

Using the technique described in chapter II of the *International Oenological Codex*, determine the cadmium content in the test solution

(5.2); the content should be less than 1 mg/kg.

5.10. Potassium Carbonate

Content

Sample: 1 g previously dried.

Analysis: Transfer sample to a beaker and dissolve it in 50 mL water. Add 2 drops of methyl red TS and, while constantly stirring, slowly titrate with 1 N hydrochloric acid until the solution becomes faintly pink. Heat the solution to boiling, cool, and continue titration until the faint pink colour no longer fades after boiling. The product intended for wine-making should contain a minimum of 98% potassium carbonate.

6. STORAGE

Potassium carbonate should be stored in airtight containers.

CALCIUM PHYTATE
Calcium inositol hexaphosphate
Calcii phytas
 $C_6H_6Ca_6O_{24}P_6 \cdot 3H_2O = 942.11$
OENO 21/2000

1. OBJECTIVE, ORIGIN AND SCOPE OF APPLICATION

Calcium phytate is the salt of the inositol hexaphosphoric ester, or inositolhexaphosphoric or phytic acid.

In its calcium and magnesium double salt forms, phytic acid composes phytin, a reserve form of phosphorous in plants.

Since it is an iron (III) complexing agent approved for removal of excess iron in wines, its use must be strictly monitored.

Any excess phytate with respect to the iron (III) content causes deposits to build up when the slightest oxidation occurs.

2. LABELING

The label should indicate product concentration even when used in mixtures, as well as its safety and storage conditions.

3. PROPERTIES

White powder with an acidulous taste, which is minimally soluble in water, soluble in dilute strong acids, and difficult to dissolve in wine, in which solubility is incomplete.

Aqueous calcium phytate solution possess an acidic nature, which is disclosed by movement of the indicator to litmus. It yields calcium reactions.

4. TESTS

4.1. Desiccation Loss

Dry a 1 g sample of calcium phytate in an oven at 105 °C until a constant weight is obtained. Weight loss should be less than 12 pp 100.

Limits indicated below are for dry product.

4.2. Ash

Incinerate a 0.250 g test sample of calcium phytate at 550 °C. The residue should not be less than 65 pp 100 nor greater than 72 pp 100 of the dry product contained in the test sample.

4.3. Insoluble Substances

Prepare a first solution containing 1 g of calcium phytate, 7 ml of 1M hydrochloric acid solution, and 93 ml of distilled water. Separately, prepare a solution of 1 g of calcium phytate with 50 ml of distilled water and 1.5 ml pure phosphoric acid (R). Filter each of the solutions separately and collect the deposit. Wash and dry the deposit at 100 °C. Each residue should be less than 1 part per 100 (10g/kg) of dried product at 105 °C.

4.4. Starch

Add several drops of iodinated water (R) to the residues obtained under Paragraph 4.3; no blue coloration should develop.

4.5. Sugars

Stir 3 g of calcium phytate with 15 ml of distilled water. Filter. The filtrate should not reduce the cupro-alkaline reagent (R) before or after the sucrose inversion.

4.6. Albumin

Dissolve 1 g of the product in a mixture of 1 ml of concentrated hydrochloric acid (R) and 3 ml of distilled water. Add 3 ml of 30% sodium hydroxide solution (R). Filter. When one drop of 4 pp 100 (m/v) copper (II) sulfate solution is added to the filtrate, no violet color should appear.

4.7. Preparing the Solution for Tests

Macerate a quantity of calcium phytate containing 5 g dry product with 100 ml of 10 g per liter citric acid (R) for 24 hours while agitating from time to time. Filter.

4.8. Iron

Add 1 ml of concentrated hydrochloric acid (R) and 2 ml of 5 pp 100 potassium thiocyanate to 10 ml of test solution prepared under paragraph 4.7. The resulting coloration should be less intense than that produced by a control tube prepared with 2.5 ml solution in a concentration of 0.010 g of iron per liter (R), 7.5 ml of distilled water, 1 ml of concentrated hydrochloric acid (R) and 2 ml of 5 pp 100 thiocyanate (R). (Iron content should be less than 50 mg/kg).

4.9. Lead

Using the method described in the Compendium, quantify lead analytically in the test solution prepared according to Par. 4.7. (Lead content should be less than 5 mg/kg).

4.10. Mercury

Using the method described in the annex, quantify mercury analytically in the test solution prepared according to Par. 4.7. (Mercury content should be less than 1 mg/kg).

4.11. Arsenic

Using the method described in the annex, quantify arsenic analytically in the test solution prepared according to Par. 4.7. (Arsenic content should be less than 3 mg/kg).

4.12. Mineral phosphates

Place 0.50 g calcium phytate in a 200 ml volumetric flask. Add 100 ml of distilled water and 5 ml of concentrated nitric acid (R). Agitate for 15 minutes at 20 °C and top off to 200 ml with distilled water. To 10 ml of this solution, add 10 ml of nitro-vanadomolybdc reagent (R). Leave in contact for 15 minutes at 20 °C. The resulting color should be less intense than that produced by adding 5 ml distilled water and 10 ml nitro-vanadomolybdc reagent (R) to 5 ml of a monopotassic phosphate solution containing 0.05 g phosphorous per liter (R). (Mineral phosphate content, expressed in terms of phosphorous, should be less than 1 pp 100).

4.13. Glycerophosphates

Heat 0.50 g of calcium phytate in the presence of monopotassic sulfate. No acrolein fumes (odor of burnt horn) should be released.

4.14. Total Phosphorous Determination

Weigh precisely a 0.25 g sample of calcium phytate which has already been dried at 105 °C. Place it in a flask which is ground and polished so it can be fitted with a tube 8 mm in diameter and 1 m long which will serve as a reflux condenser. Add 5 ml of concentrated sulfuric acid (R) and 0.5 ml concentrated nitric acid (R). Bring to boiling under reflux for approximately 15 minutes. After cooling, decant the contents of the flask diluted with water in a 1 liter volumetric flask. Wash the condenser and flask with water by pouring these liquids in the volumetric flask, and fill to gauge line after bringing the temperature to 20 °C. Agitate.

Add 10 ml of nitro-vanadomolybdc reagent (R) to 10 ml of this solution. Agitate in a 20 °C water bath and let sit in the water bath for 15 minutes. The intensity of the resulting color should be equal to or greater than that of a control prepared under the same conditions using 8 ml of monopotassic phosphate solution in a concentration of 0.05 g of

phosphorous per liter (R), 2 ml of water and 10 ml of nitro-vanadomolybdic reagent (R).

Total phosphorous analysis can also be determined using a spectrophotometer with a wavelength of 425 nm whose calibration curve was obtained based on 4-6-8-10 ml of solution in a concentration of 0.05 mg phosphorous per liter (R).

Calcium phytate should contain at least 15 parts of phosphorous per 100 , as compared with a product dried at 105 °C.

5. STORAGE

Calcium phytate should be stored in a dry place in hermetically sealed containers.

CALCIUM TARTRATE
Dextrorotatory Calcium Tartrate
Calcium tartaricum
(OOC-CHOH-CHOH-COO) Ca, 4H₂O
Tetrahydric L(+)-2,3- calcium dihydroxybutanedioate
(OOC-CHOH-CHOH-COO) Ca, H₂O
C₄H₁₂CaO₁₀ = 260.13
SIN No. 354
OENO 22/2000

1. OBJECTIVE, ORIGIN AND SCOPE OF APPLICATION

A natural wine salt primarily originating from wine residues. It is therefore typically found in L(+) form. It usually crystallizes in tetrahydrated form.

This product promotes triggering of the precipitation of the natural calcium tartrate in wine by means of a seeding technique.

2. LABELING

The label should indicate product concentration, even when used in mixtures, as well as its safety and storage conditions.

3. CENTESIMAL COMPOSITION

Tartaric acid	57.7
Calcium	15.4
Water	27.9

4. PROPERTIES

Fine, crystalline powder with a white or off-white color. Tasteless. Melting point is 270 °C.

5. SOLUBILITY

Water at 20 °C	0.525 g/l
Alcohol, 95% by vol.	0.15 g/l
Ethyl ether	0.01 g/l

6. TESTS**6.1. Rotatory Power**

Dissolve 1 g of the substance in 1l of 1 M hydrochloric acid. After it has completely dissolved, it gives :

$$[\alpha]_{\text{D}}^{20^{\circ}\text{C}} = +7.2 \pm 0.2^{\circ}.$$

Rotatory power is sensitive to slight variations in pH.

6.2. pH in Saturate Solution

Add 1 g of the product to 100 ml of distilled water. After shaking for one hour and allowing the precipitate to resettle (15 minutes), an increase in pH of between 1.5 and 2.5 pH units should be observed.

6.3. Desiccation Loss

Desiccation loss is determined up to constant weight in precisely-weighed sample of about 1 g. At a temperature of between 100 and 105 °C, weight loss should be less than or equal to 2.5 pp 100.

6.4. Preparing the Solution for Tests

Dissolve a sample precisely weight to about 1 g in 100 ml of 1 M hydrochloric acid.

6.5. Sulfates

Take 10 ml of the test solution (Par. 6.4) and add to it 1 ml of 10 pp 100 barium chloride solution (R). After homogenization, let sit after 15 minutes. No clouding should occur. If clouding does occur, it should be less intense than that in a control prepared using the method indicated in the Annex. (Sulfate content, expressed in terms of sulfuric acid, should be less than 1 g/kg).

6.6. Heavy Mmetals

Add 0.5 ml of concentrated ammonium hydroxide (R), 2 ml of pH 3.5 buffer solution (R) and 1.2 ml of thioacetamide reagent (R) to 10 ml of the test solution prepared under paragraph 6.4. (Heavy metal content, expressed in terms of lead, should be less than 10 mg/kg).

6.7. Lead

Using the method described in the Compendium, quantify lead analytically in the test solution prepared according to Par. 6.4. (Lead content should be less than 5 mg/kg).

6.8. Mercury

Using the method described in the Annex, quantify mercury analytically in the test solution prepared according to Par. 6.4. (Mercury content should be less than 1 mg/kg).

6.9. Arsenic

Using the method described in the Annex, quantify arsenic analytically in the test solution prepared according to Par. 6.4. (Arsenic content should be less than 3 mg/kg).

6.10. Basic Residue Determination

Dissolve a sample, **p**, of tetrahydric calcium tartrate weighed precisely at about 0.5 g in 25 ml of 1 M hydrochloric acid solution (R). Bring to boiling under reflux and allow to cool. Titrate the excess acid using 1 M sodium hydroxide solution (R) and in the presence of methyl red (R). Let *n* be the quantity in millimeters of the 1 M sodium hydroxide solution used. 1 ml of 1 M hydrochloric acid corresponds to 0.05005 g of calcium carbonate. The content in parts per 100 of calcium carbonate is:

$$(25n) 5.005 / p$$

The products used in winemaking should contain a maximum of 3 pp 100 basic residues expressed in terms of calcium carbonate.

7. STORAGE

Calcium tartrate should be stored away from moisture in hermetically-sealed containers.

CALCIUM SULFATE
CaSO₄ x 2 H₂O (Dihydrate)
CAS NUMBER 10101-41-4
OIV-OENO 644-2020

1. OBJECTIVE AND SCOPE OF APPLICATION

This product is used for must acidification in the production of liqueur wines. Calcium sulfate added reacts with tartrate ions of the must producing insoluble calcium tartrate and releasing ion sulfate in the must. These facts originate modifications in ions equilibria that liberates proton ions and reduces the pH without increasing the titratable acidity.

2. LABELING

The label should indicate the nature of calcium sulfate, batch number and the storage and safety requirements.

3. STOICHIOMETRIC COMPOSITION

CaSO₄: 79.1 %

H₂O: 20.9 %

4. PROPERTIES

Calcium sulfate dihydrate exists as a white amorphous powder. Not to be confused with the anhydrous form which is very hygroscopic and sets in contact with must.

5. SOLUBILITY

Slightly soluble in water and soluble in hydrochloric, sulphuric and nitric acid solutions.

6. TESTS**6.1. Desiccation losses**

Free water: Weigh 50 g of calcium sulphate in a dish. Place it in an oven at 40 °C until constant weight. Weight loss should not exceed 2 %.

Free and bonded water: Place another sample in an oven at 200 °C during 4 h. Total weight loss should not exceed 23 %.

6.2. Preparing the Solution for Tests

Weigh 10 g of calcium sulphate. In a 500 ml erlenmeyer flask which can be hermetically sealed, add 200 ml of tartaric acid solution at 5 g/L per

litre and bring to pH 3 with HCl 0.1 N. Put this in a magnetic mixer, sprinkle gently the calcium sulphate and mix for 1 hour at a temperature of $20 \pm 2^{\circ}\text{C}$. Allow to settle and filter by eliminating the first 50 ml of filtrate. Collect at least 100 ml of clear liquid.

6.3. Lead

Using the technique described in the Compendium, analyse quantitatively the lead in the solution prepared for testing (Par. 6.2). Lead content in calcium sulfate should be less than 2 mg/kg.

6.4. Mercury

Using the technique described in the Compendium, analyse quantitatively the mercury in the solution prepared for testing (Par. 6.2). Mercury content in calcium sulfate should be less than 1 mg/kg.

6.5. Arsenic

Using the technique described in the Compendium, analyse quantitatively the arsenic in the solution prepared for testing (Par. 6.2). Arsenic content in calcium sulfate should be less than 3 mg/kg.

6.6. Iron

Using the technique described in the Compendium, analyse quantitatively the iron in the solution prepared for testing (Par. 6.2). Iron content should be less than 200 mg/kg.

6.7. Quantitative Analysis

Any method of analysis included in the Compendium could be used. In the case of using the gravimetric method OIV-MA-AS321-05A, use the following procedure. Weigh 250 milligrams of the sample dried at 40°C with a precision of 1 mg and dissolve it in 10 mL HCl 1M. Take 5 mL of this solution and add 0,5 mL of HCl 2 M and 1,5 mL of a solution of BaCl_2 400 g/L. Stir with a glass stirrer; rinse the stirrer with a little distilled water and leave to stand for 5 min. Centrifuge for 5 min at 3.000 rpm, then carefully decant the supernatant liquid. Wash the barium sulfate precipitate as follows: add 10 mL hydrochloric acid 2 M, place the precipitate in suspension and centrifuge for 5 min at 3.000 rpm, then carefully decant the supernatant liquid. Repeat the washing procedure twice as before using 15 mL distilled water each time. Quantitatively transfer the precipitate, with distilled water, into a tared platinum capsule and place over a water bath at 100°C until fully evaporated. The dried precipitate is calcined several times briefly over a flame until a white residue is obtained. Leave to cool in a desiccator and weigh:

Calculations

Content of calcium sulfate dihydrate in the product (%) = $p \times 0.59021$

Where p is the measured weight of $BaSO_4$ in mg.

If other method of analysis of sulphates included in the Compendium is used to analyse the initial solution of calcium sulfate prepared for quantitative analysis:

Content of calcium sulfate dihydrate in the product (%) = $c \times 3.9522 \cdot 10^{-3}$

Where c is the concentration of sulfates in mg/L of K_2SO_4

The wine-making product must contain a minimum of 90 pp 100 calcium sulfate.

7. STORAGE

Calcium sulfate should be stored in a dry place in hermetically sealed containers away from volatile elements it could adsorb.

CARAMEL
N° SIN: 150
OENO 20/2004

1. OBJECT, ORIGIN AND FIELD OF APPLICATION

Caramel can be found in liquid form or solid form ranging in colour from dark brown to black. Colouring wine in the *stricto sensu* is not allowed but caramel is used as a colouring agent in certain liquor wines, spirit beverages of vitivinicultural origin and wine-based beverages.

2. DEFINITIONS

CARAMEL (OR ORDINARY CARAMEL) (Class I) (SIN: 150a)

Caramel (or ordinary caramel) is prepared by controlled heating of carbohydrates made up of glucose and fructose monomers and/or their respective polymers (for example, glucose syrup, saccharose and/or inverted sugars syrups). To favour caramelisation, acids, bases and salts excluding ammonium compounds can be used.

CAUSTIC SULPHITE CARAMEL (Class II) (SIN: 150b)

Caustic sulphite caramel is prepared by controlled heating of carbohydrates as defined for ordinary caramel, with or without acids or bases, in the presence of sulphite compounds (sulphuric acid, potassium sulphite, potassium hydrogen sulphite, sodium sulphite and sodium hydrogen sulphite). No ammonium compounds are used.

AMMONIA CARAMEL (Class III) (SIN: 150c)

Ammonia caramel is prepared by controlled heating of carbohydrates as defined for ordinary caramel, with or without acids or bases, in the presence of ammonium compounds (ammonium hydroxide, ammonium carbonate, ammonium hydrogen carbonate, and ammonium phosphate). No sulphite compounds are used.

AMMONIUM SULPHITE CARAMEL (Class IV) (SIN: 150d)

Ammonia sulphite caramel is prepared by controlled heating of carbohydrates as defined for ordinary caramel, with or without acids

or bases, in the presence of sulphite and ammonium compounds (sulphuric acid, potassium sulphite, potassium hydrogen sulphite, sodium sulphite, sodium hydrogen sulphite, ammonium hydroxide, ammonium carbonate, ammonium hydrogen carbonate, ammonium phosphate, ammonium sulphate, ammonium sulphite and ammonium hydrogen sulphite).

3. LABELLING

The concentration of the product and whether it was mixed, must be indicated on the label in addition to the storage conditions.

4. TEST TRIALS**4.1 Intensity of the colouring**

The intensity of the colouring is defined as the absorbance of a liquid solution of 0.1% (m/v) concentrated caramel measured in a 1 cm space of optical pathway with light waves of 610 nm.

4.2 Total Nitrogen

Apply the method described in Chapter II of the International Oenological Codex to 2 g of exactly measured caramel.

4.3 Preparation of the solution for the test trials

Place 2 g of caramel in a capsule; put in heat chamber at 105°C for 4 hours than incinerate carefully without going beyond 550°C.

Take the cinders and put in 10 ml of 10% hydrochloric acid (R). Heat a little and transfer to a graduated 50 ml flask and rinse the capsule with water and fill up to the indicator.

4.4 Heavy metals

Take 10 ml of the solution prepared for the trial tests as in point 4.3, and add 2 ml of 3.5 pH buffer solution (R) and 1.2 ml of thioacetamide reagent (R). If the solution turns brown, it must be less brown than the control sample, as indicated in Chapter II of the International Oenological Codex.

4.5 Lead

Using the solution for test trials as prepared in the point 4.3, measure out the lead as indicated in Chapter II of the International Oenological Codex.

Please refer to point 5 for maximum contents.

4.6 Mercury

Measure out the mercury using the method described in Chapter II of the International Oenological Codex.

Please refer to point 5 for maximum contents.

4.7 Cadmium

Test solution prepared according to point 4.3; Measure out the cadmium using the method described in Chapter II of the International Oenological Codex.

Please refer to point 5 for maximum contents.

4.8 Arsenic

Test solution prepared according to point 4.3; Measure out the arsenic using the method described in Chapter II of the International Oenological Codex.

Please refer to point 5 for maximum contents.

4.9 Colouring matter retained on DEAE cellulose

See method as described by JECFA published in the Compendium of food additive specifications, FAO Food and Nutrition Paper 52 Add. 8.

4.10 Colouring matter retained on phosphorylcellulose

See method as described by JECFA published in the Compendium of food additive specifications, FAO Food and Nutrition Paper 52 Add. 8.

4.11 4-Methylimidazole

See method as described by JECFA published in the Compendium of food additive specifications, FAO Food and Nutrition Paper 52 Add. 8.

4.12 2-Acetyl-4-tetrahydroxybutylimidazole

See method as described by JECFA published in the Compendium of food additive specifications, FAO Food and Nutrition Paper 52 Add. 8.

4.13 Total sulphur

See method as described by JECFA published in the Compendium of food additive specifications, FAO Food and Nutrition Paper 52 Add. 8.

4.14 Sulphur dioxide

The method used can be found in the O.I.V. Compendium of International Methods of Analysis of Wine and Musts.

5. PARTICULAR SPECIFICATIONS**5.1 Ordinary caramel**

Colouring matter retained on DEAE cellulose	Not more than 50%
Colouring matter retained on phosphorylcellulose	Not more than 50%
Colour intensity	0.01 – 0.12
Total nitrogen	Not more than 0.1%
Total sulphur	Not more than 0.3%
Arsenic	Not more than 1 mg/kg
Lead	Not more than 2 mg/kg
Mercury	Not more than 1 mg/kg
Cadmium	Not more than 1 mg/kg
Heavy metals (expressed in Pb)	Not more than 25 mg/kg

5.2 Caustic sulphite caramel

Colouring matter retained on DEAE cellulose	Not more than 50%
Colour intensity	0.06 – 0.10
Total Nitrogen	Not more than 0.2% (1)
Total sulphur dioxide	Not more than 0.2% (1)
Total sulphur	1.3 – 2.5% (1)
Sulphur retained on DEAE cellulose	Over 40%
Percentage of optical colour density retained on DEAE cellulose	19-34
OD 280/560 ratio	Over 50
Arsenic	Not more than 1 mg/kg
Lead	Not more than 2 mg/kg
Mercury	Not more than 1 mg/kg
Cadmium	Not more than 1 mg/kg
Heavy metals (expressed in lead)	Not more than 25 mg/kg

(¹) Expressed by the intensity of equivalent colouring; or compared to a product with a colour intensity of 0.1 unit of absorption.

5.3 Ammonia caramel

Colouring matter retained on DEAE cellulose	Not more than 50%
Colour matter retained on phosphorylcellulose	Not more than 50%
Colour intensity	0.08 – 0.36
Ammoniac nitrogen	Not more than 0.4% (¹)

4-Methylimidazole	Not more than 250 mg/kg ⁽¹⁾
2-Acetyl-4-tetrahydroxybutylimidazole	Not more than 10 mg/kg ⁽¹⁾
Total sulphur	Not more than 0.3% ⁽¹⁾
Total nitrogen	1.3 – 6.8% ⁽¹⁾
Percentage of optical colour density retained on phosphorylcellulose	13-35
Arsenic	Not more than 1 mg/kg
Lead	Not more than 2 mg/kg
Mercury	Not more than 1 mg/kg
Cadmium	Not more than 1 mg/kg
Heavy metals (expressed in lead)	Not more than 25 mg/kg

⁽¹⁾ Expressed by the intensity of equivalent colouring; or compared to a product with a colour intensity of 0.1 unit of absorption.

5.4 Ammonium sulphite caramel

Colouring matter retained on DEAE cellulose	Not more than 50%
Colour intensity	0.10 – 0.60
Ammoniac nitrogen	Not more than 2.6% ⁽¹⁾
Sulphur dioxide	Not more than 0.5% ⁽¹⁾
4-Methylimidazole	Not more than 250 mg/kg ⁽¹⁾
Total nitrogen	0.5 – 7.5% ⁽¹⁾
Total sulphur	1.4 – 10% ⁽¹⁾
Nitrogen/sulphur precipitation by alcohol ratio	0.7 – 2.7
OD precipitation by alcohol ratio ⁽²⁾	8-14
OD 280/560 ratio	Not more than 50 ⁽²⁾
Arsenic	Not more than 1 mg/kg
Lead	Not more than 2 mg/kg
Mercury	Not more than 1 mg/kg
Cadmium	Not more than 1 mg/kg
Heavy metals (expressed in lead)	Not more than 25 mg/kg

⁽¹⁾ Expressed by the intensity of equivalent colouring; or compared to a product with a colour intensity of 0.1 unit of absorption.

⁽²⁾ The optical densities of precipitation by alcohol is defined as the optical density of precipitation at 280 nm divided by the optical density at 560 nm (in a 1 cm space).

6. STORAGE CONDITIONS

Caramel must be stored in a closed container.

7. REFERENCES

- Directive 95/45/CE Journal officiel des Communautés européennes, L 226, 22 September 1995.

- Compendium of food additive specifications, Addendum 8, FAO Food and Nutrition Paper 52 Add.8.
Joint FAO/WHO Expert Committee on Food Additives (JECFA) ISBN 92-5-104508-9.

**CARBON DIOXIDE
CARBONIC ANHYDRIDE***Carbonei dioxydum***CO₂ = 44.01****SIN No. 290**

OENO 26/2000

1. OBJECTIVE, ORIGIN AND SCOPE OF APPLICATION

Carbon dioxide is used in gaseous form, either pure or mixed with nitrogen, in procedures designed to render inert.

2. LABELING

The label should indicate the nature and purity of the gaz, even when used in mixtures, as well as its safety and storage conditions.

3. PROPERTIES

Carbon dioxide gas is colorless and odorless. Its aqueous solution has a slightly acidic taste. At a temperature of 0 °C and under a pressure of 760 mm of mercury, 1 l of carbon dioxide weighs 1.977 g.

At a temperature of 20 °C and under a pressure of 760 mm of mercury, 1 l of water dissolves 878 ml of carbon dioxide, or 1.736 g of CO₂.

If a flame is placed in a tube of carbon dioxide, the flame is extinguished.

Fill a 50 ml test tube with carbon dioxide. Shake with 10 ml of barium hydroxide solution. A white precipitate will form, which becomes soluble with effervescence by a dilute acetic acid solution (10 pp 100) (R).

4. TESTS

Total purity of carbon dioxide should be 99 parts per 100 by volume.

Testing for and quantitative determination of gaseous impurities can be performed by gas phase chromatography. The method is described in the Annex.

Carbon dioxide determination can also be accomplished using the following chemical tests.

For the following tests, tubes containing carbon dioxide should be kept at ambient temperature for at least 6 hours prior to sampling. Volumes to be sampled are calculated by taking temperature and pressure into account, which are indicated here to be 0 °C and 760 mm of mercury.

4.1. Sulfuric Acid and Sulfur Dioxide

Let 1000 ml carbon dioxide flow, during 15 minutes at a constant speed, into 50 ml of water that has recently been boiled and cooled to room temperature. The feed tube should have an orifice whose diameter is approximately 1 mm and which is immersed to within 2 mm of the bottom of the water container which has a height of 12-14 cm. After the flow of gas is completed, pour the liquid in bucket A of a comparator and add 0.05 ml of methyl orange solution (R). To bucket B, which contains 50 ml of recently boiled and cooled water, add 1 ml of 0.01 M hydrochloric acid solution, then 0.05 ml of methyl orange solution (R). The red tint in bucket A should not be darker than that of the liquid in bucket B.

4.2. Hydrogen Sulfide, Hydrogen Phosphide, Arsine and Organic Reducing Substances

Under the same conditions as those in the preceding test, let 1000 ml of carbon dioxide flow into a mixture of 10 ml of ammoniacal silver nitrate solution (R), 3 ml of concentrated ammonium hydroxide (R) and 15 ml of distilled water. There should be no clouding or brown color as compared to an identical control solution through which no carbon dioxide gas flowed.

4.3. Oxygen

For oxygen determination tests (see « Nitrogen »), pierce the stopper of a flask with a 8/10 mm hypodermic needle (take care not to dip the needle into the liquid). This needle will allow gas to escape after bubbling. Next, insert a second hypodermic needle of the same size to feed the expanding gas into the liquid. After a minute of bubbling, there should be no significant colorating. In the presence of oxygen, the liquid will rapidly turn blue and the color become more intense over time.

4.4. Carbon Monoxide

The limiting carbon monoxide content as determined using the method described in the annex is 10µl/l

4.5. Oil

The limiting oil content as expressed by the quantity absorbed by a suitable trap, as described in the technique described in the annex, is 0.1 mg/l.

4.6. Quantitative Analysis

Place approximately 100 ml of carbon dioxide, measured with precision, in a graduated volumetric flask turned over on a mercury

tank or a graduated gas burette filled with mercury. Using a curved pipette on the mercury tank or by exerting pressure of mercury using an appropriate device, force the gas into a tube or absorber tank containing a sufficient quantity of an aqueous solution which contains 40 g of potassium hydroxide (R) per 100 ml. Shake for 5 minutes to ensure efficacious contact between the liquid and the gas. Again, feed the gas freed from the aqueous liquid to the graduated flask or the burette. Read the residual volume at the same temperature and under the same pressure as those at which the sample was measured. Once again, place the residual gas in contact with the alkaline solution and take a second residual volume reading to verify absorption was complete. There should be no more than 1 pp 100 of non-absorbable gas.

5. STORAGE

Carbon dioxide is stored in steel canisters which are painted gray. The strength of these canisters should be periodically checked.

CASEINS
(Lactic Casein or Caseina acids)

OENO 12/2003;
OIV-OENO 555-2015

1. OBJECT, ORIGIN AND FIELD OF APPLICATION

Casein, a heteroprotein containing phosphorous, is found in milk in the state of calcium salt.

It is obtained by coagulating skim milk.

It is the fining agent indicated for the treatment of oxidations in wine. It can only be used in alkaline water with potassium carbonate or potassium hydrogenocarbonate.

Casein adsorbs polyphenols, in particular oxidised polyphenols.

2. LABELLING

The concentration of casein used for the preparation must be indicated on the label including in the case of a mixture, as well as the storage conditions.

3. CHARACTERISTICS

Casein is a yellowish white coloured powder. It is amorphous, odourless and insoluble in pure water and various organic solvents. It can have a slight lactic odour. In alkaline water or in saline solutions with alkaline reactions, it swells and produces a colloidal solution: 100 ml of alkaline water for 1 g of potassium hydroxide or sodium hydroxide, dissolve 10 g of casein in a water bath at 100°C. The solution diluted 20 times its volume in water is cloudy; it should be free of lumps.

The so-called soluble caseins are mixed with pure powder and/or potassium carbonate (maximum 20%), or potassium hydrogenocarbonate).

Caseins used in oenology are fit for human consumption.

4. IDENTIFYING CHARACTERISTICS

4.1 Casein doesn't precipitate by heating its alkaline solution. This solution precipitates by acidification once the pH is less than 5.

4.2 Casein ashes contain phosphates characterised by the nitromolybdic reagent (R).

5. TEST TRIALS

Casein should have no flavour, nor abnormal odour (rotten, mouldy, putrid, etc.)

5.1 Acidity

5.1.1 Principle

Determining free acidity in casein by an acidobasic determination of an aqueous extract of the product.

5.1.2 Reagents

- Sodium hydroxide 0.1 M
- Phenolphthalein, solution at 10 g/l in ethanol

5.1.3 Procedure

Preliminary test:

- Homogenise the product by shaking vigorously;
- Put 50 g of the product on a strainer (metal mesh strainer 200 mm in diameter, nominal size of 500 µm for the opening with a receptacle (Standard ISO 3310/1));
- If 50 g of the product passes through completely, use the product as it is;
- If the 50 g of the product do not pass through, grind the product until 50 g do pass through.

During all these operations, avoid changing the water content of the product.

Preparation for the test trial solution:

- Take approximately 10 g to the nearest 10 mg of the 50 g passed through the strainer, or m of this mass.

- Put the mass m in a 250 ml conical flask.
- Pour 200 ml of recently boiled distilled water brought to 60°C into the flask.
- Shake the closed flask.
- Allow to stand for 30 minutes in a water bath at 60 °C while shaking the flask every 10 minutes.
- Filter.

The filtrate at 20°C must be clear.

Carrying out the test:

- Take 100 ml of filtrate.
- Place the test sample in a 250 ml conical flask.
- Add 0.5 ml of phenolphthalein solution to the flask.
- Titrate using 0.1 M sodium hydroxide solution.
- Let V represent the volume used.

5.1.4 Calculation

Free acidity in casein expressed in meq/l is equal to:

$$\frac{20 \cdot V \cdot T}{m}$$

- V is the volume in ml of sodium hydroxide used.
 - T is the exact mole fraction of the sodium hydroxide solution.
 - m is the mass density in g of the test trial sample.
- Acidity expressed as lactic acid should be less than 1.6 g/l.

5.2 pH

Shake 10 g of casein in 100 ml of water for a few minutes. Decant; the pH of the solution should be less than or equal to 5 for pure casein.

5.3 Loss by dessication

Determine the weight loss of 2 g of the test trial sample by drying to constant weight at 100°C-105°C . Weight loss of casein must be less than 12%.

All the limits set below apply to dried products.

5.4 Ashes

Incinerate the residue left in the weight loss determination by desiccation, without exceeding 600 °C.

The rate of the ashes should be less than 3% for casein acid and less than 23% for the casein acid and potassium carbonate or potassium hydrogenocarbonate mixture.

5.5 Preparation of test trial solution

After determining the weight of the ashes, dissolve them in 2 ml of concentrated hydrochloric acid (R) and 10 ml of water. Heat to dissolve and add water until reaching a volume equal to 25 times the weight of dried casein. 1 ml of this solution contains 0.04 g of dried casein mineral matters.

5.6 Iron

Take 10 ml of the test trial solution (5.5), and add 1 ml of concentrated hydrochloric acid (R), 3 drops of hydrogen peroxide solution at 3 volumes(R) and 2 ml of potassium thiocyanate solution at 5% (R).

If a red colouration appears, it must be lighter than the control prepared with 8 ml of iron solution (III) at 0.01 g of iron per litre (R), 2 ml of water and the same volumes of concentrated hydrochloric acid (R) and potassium thiocyanate solution at 5% (R).

Iron content should be less than 200 mg/kg.

This determination can also be carried out by atomic absorption spectrophotometry.

5.7 Lead

On the test trial solution (5.5), determine the lead according to the method described in Chapter II of the International Oenological Codex.

Lead content should be less than 5 mg/kg.

5.8 Cadmium

On the test trial solution (5.5), determine the cadmium according to the method described in Chapter II of the International Oenological Codex.

Cadmium content should be less than 1 mg/kg.

5.9 Mercury

Determine the mercury according to the method described in Chapter II of the International Oenological Codex.

Mercury content should be less than 1 mg/kg.

5.10 Arsenic

On the test trial solution (5.5), determine the arsenic according to the method described in Chapter II of the International Oenological Codex.

Arsenic content should be less than 3 mg/kg.

5.11 Total nitrogen

Introduce approximately 0.20 g of casein precisely weighed in a mineralisation flask with 15 ml of concentrated sulphuric acid (R) and 2 g of mineralisation catalyst (R) and continue the operation according to the method in chapter II of the International Oenological Codex.

Total nitrogen content must be more than 13%.

5.12 Proteins

Protein content should not be less than 82% of weight (total nitrogen 6.38).

5.13 Fat content

Determine the fat content using the gravimetric Schmid-Bondzynski-Ratslaff method (standard ISO 5543).

Fat content should be less than 2%.

5.14 Bacteriological monitoring

Proceed as indicated in chapter II of the International Oenological Codex.

Limit: total viable microorganisms: less than 3×10^4 CFU/g.

5.15 Coliforms

Proceed with counting according to the method in chapter II of the International Oenological Codex.

Absence must be checked on a sample of 25 g.

5.16 Staphylococci

Proceed with counting according to the method in chapter II of the International Oenological Codex.

The number of staphylococci (β -hemolytiques positive coagulase) must be less than or equal to 1 per g.

5.17 Escherichia Coli

Proceed with counting according to the method in chapter II of the International Oenological Codex.

Absence must be checked on a sample of 1 g.

5.18 Salmonella

Proceed with counting according to the method in chapter II of the International Oenological Codex.

The number of salmonella should be less than 1 per 100 g.

5.19 Yeasts

Proceed with counting according to the method in chapter II of the International Oenological Codex.

Content limit: 10^3 CFU/g of preparation.

5.20 Lactic bacteria

Proceed with counting according to the method in chapter II of the International Oenological Codex.

Content limit: 10^2 CFU/g of preparation.

5.21 Lactobacillus sp.*

Content limit: 10 CFU/g of preparation.

5.22 Pediococcus sp.*

Content limit: absence in a 10 g preparation sample.

5.23 Acetic bacteria

Proceed with counting according to the method in chapter II of the International Oenological Codex.

Content limit: 10^3 CFU/g of preparation

* Method to be defined later on

5.24 Mould

Proceed with counting according to the method in chapter II of the International Oenological Codex.

Content limit: 10^3 CFU/g of preparation

6. STORAGE

Casein must be stored in watertight bags between 5°C and 20°C with relative humidity less than 65%. Its shelf life is 24 months.

7. REFERENCES

Standard ISO 5543.

CATION-EXCHANGE RESINSOENO 4/95;
OENO 43/2000**1. OBJECTIVE, ORIGIN AND SCOPE OF APPLICATION**

Ion exchange is the reversible exchange of ions between a liquid and a solid, during the course of which the solid does not undergo any substantial changes. When this technique is applied to wine, the solid is an insoluble, permeable synthetic resin capable of exchanging ions with the wine with which it is in contact.

These resins are used in the tartaric stabilization of wine.

2. COMPOSITION

Cation exchange resins may be prepared in an appropriate physical form using one or more of the following formulas.

1. Sulfonated styrene-divinylbenzene copolymer:

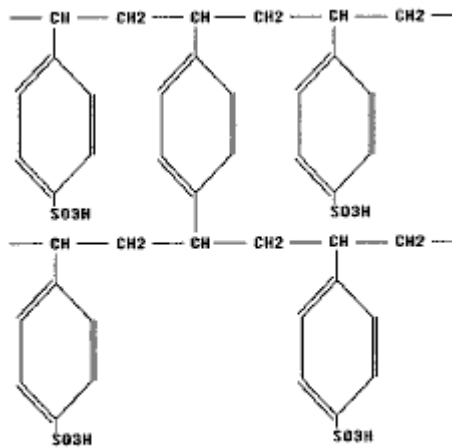

2. Divinylbenzene-methacrylic acid copolymer:

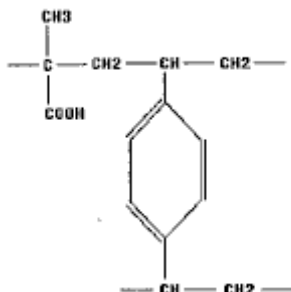

Resin inertia must be satisfactory.

The substances which can be used in the manufacture of these resins are indicated in Annexes 1 and 2.

The resin should not contain more than 1 mg of extractable organic substance per kg. These organic extracts are obtained with each of the following solvents: a) distilled water, b) alcohol, 15% by volume, c) 3% acetic acid solution (m/m).

The resin must have been washed and conditioned in accordance with the manufacturer's instructions.

Prepare different ion exchange columns for each solvent, using 50 ml of the resin that has previously been weighed.

While maintaining the maximum temperature that may be encountered during use, pass the three solvents used in the analysis (distilled water, 15% hydroalcoholic solution and 3% acetic acid solution (m/m)) through the resins at a flow rate of 350-450 ml per hour.

The first liter of effluent from each solvent should not be considered for analytical purposes; only the following two liters of each solvent should be used to analyze the organic extracts.

Total extract : The two liter sample should be evaporated at 105 °C until a constant weight is obtained.

Ash : This dry residue derived from evaporation of the 2 liters of effluent is then burned in an oven at 850 °C until a constant weight is obtained.

Organic extract : Total extract minus total ash gives the organic extract. If the organic extract is greater than 1 ml/l of solvent used, a "blank" should be made using the solvent and a correction should be made by subtracting the organic extract found in the "blank" from that obtained during the resin test. The solvents used are prepared as follows:

Control reagents:

Distilled and/or de-ionized water.

Ethyl alcohol at 15% by volume obtained from absolute ethyl alcohol and distilled and/or de-ionized water.

3% acetic acid produced by mixing 3 parts (by mass) of acetic acid with 97 parts (by mass) of distilled and/or de-ionized water.

3. LIMITS

- The treatment must not alter the nature of the wine.
- The treatment must not reduce the color intensity of the wine.
- The treatment must not decrease the concentration of metallic cations in the wine below 300 mg/l.
- The treatment must not lower the wine's pH below 3.0. The decrease in pH should not exceed 0.3 pH units.
- The resin must not leave substances in the wine or impart to it characteristics (as a result of the resin-based treatment) that do not ordinarily exist in wine.

The winemaker may use conditioning agents and/or regenerants composed of water and inorganic acids, bases or salts, provided that the

conditioned or regenerated resin is washed in water until all conditioning agents and regenerants are removed before adding the wine.

Annex 1

List of substances used in the manufacture of adsorbant ion-exchange resins used to condition foodstuffs.

List 1

Substances assessed by an international organization

NAME	PM/REF	CASE	RESTRICTIONS
Monomers and other Starting substances			
n-butyl acrylate	10780	00141-32-2	-
Ethyl acrylate	11470	00140-88-5	-
Methyl acrylate	11710	00096-33-3	-
Acrylonitrile	12100	00107-13-1	SML = ND (DL = 0.02 mg/kg) SML = 15 mg/kg
Formaldehyde	17260	00050-00-0	-
Methyl methacrylate	21130	00080-62-6	-
Methanol	21550	00067-56-1	-
Styrene	24610	00100-42-5	-
Chemical Modifiers			
Carbonic acid, salts	42500	-	-
Hydrochloric acid	72640	07664-38-2	-
Silicic acid, salts	85980	-	-
Sulfuric acid	91920	07664-93-9	-
Acetic anhydride	10150	00108-24-7	-
tert-butyl-4-hydroxyanisole (BHA)	40720	25013-16-5	SML=30 mg/kg
Diethylene triamine	15790	00111-40-0	SML= 5 mg/kg
Dimethylamine	49225	00124-40-3	SML=0.06 mg/kg
2-(dimethylamino)ethanol	49235	00108-01-0	SML=18 mg/kg
Formaldehyde	54880	00050-00-0	SML=15 mg/kg
Hexamethylenediamine	18460	00124-09-4	SML=2.4 mg/kg
Potassium hydroxide	81600	01310-58-3	-
Sodium hydroxide	86720	01310-73-2	-
Sodium nitrite	86920	07632-00-0	SML=0.6 mg/kg
Ethylene oxide	17020	00075-21-8	MQ=1 mg/kg in FP
2-propanol	81882	00067-63-0	-
Polymerization Additives			
Alkylsulfonic acids (C ₈ -C ₂₂)	34230	-	SML=6 mg/kg
Linear, primary alkylsulfuric acids (C ₈ -C ₂₂) having an even number of carbon atoms	34281	-	-
Formic acid	55040	00064-18-6	-
Carboxymethylcellulose	42640	09000-11-7	-
Stannic chloride(IV)	93420	07646-78-8	-
Methylene chloride	66620	00075-09-2	SML=0.05 mg/kg
1,4-dihydroxybenzene	48620	00123-31-9	SML=0.6 mg/kg
Gelatin	55440	09000-70-8	-
Ammonium hydroxide	35600	01336-21-6	-
Magnesium hydroxide	64640	01309-42-8	-
Hydroxyethylcellulose	60560	09004-62-0	-
Hydroxyethylmethylcellulose	60880	09032-42-4	-
Methanol	65960	00067-56-1	-
Methylcarboxymethylcellulose	66200	37206-01-2	-
Methyl isobutyl ketone	66725	00108-10-1	SML=5 mg/kg

INTERNATIONAL GENOTOXICOLOGICAL CODEX

Cation Exchange Resins

COEI-1-RESECA: 2000

Toluene

93540 00108-88-3

SML=1.2 mg/kg

Annex 2

Substances that may be used provisionally to manufacture ion-exchange resins.

List 2

1. Substances not fully evaluated by an international organization

NAME	PM/REF	CASE	RESTRICTIONS
Monomers and other starting substances			
Ethylene glycol dimethacrylate	20440	00097-90-5	-
Divinylbenzene	16690	01321-74-0	-
Diallyl ether of 1,1,1-tri-methylolpropane	25645	00682-09-7	-
2,3-epoxypropyl methacrylate	20590	00106-91-2	-
2-methyl-1,3-butadiene	21640	00078-79-5	-
1,7-octadiene	22585	03710-30-3	-
1,1,1-trimethylolpropane trimethacrylate	25840	03290-92-4	-
Chemical Modifiers			
N,N-dimethyl-1,3-diaminopropane	49380	00109-55-7	-
Triethylamine	95270	00121-44-8	-
Triethylene tetramine	25520	00112-24-3	-
Polymerization Additives			
Polyvinyl alcohols	81280	09002-89-5	-
4-tert-butylcatechol	40640	00098-29-3	-
Diisobutyl ketone	49050	00108-83-8	-
Sodium hypochlorite	62110	07681-52-9	-
Isobutanol	62270	00078-83-1	-
4-methoxyphenol	66030	00150-76-5	-
Methylene bis(sodium naphthalenesulfonate)	66600	26545-58-4	-
2-methyl-2-pentanol	66860	00108-11-2	-
Dibenzoylperoxide	46440	00094-36-0	-
Partially hydrolyzed vinyl polyacetate	81260	-	-

2. Substances not evaluated by an international organization

NAME	PM/REF	CASE	RESTRICTIONS
Monomers and other starting substances			
Dimethoxymethane	-	00109-87-5	-
Diethylene glycol divinyl ether	-	00764-99-8	-
Ethyl vinyl benzene	-	28106-30-1	-
1,2,4-trivinyl cyclohexane	-	02855-27-8	-
Chemical Modifiers			
Chlorosulfonic acid	-	07790-94-5	-
Monochloroacetic acid	-	00079-11-8	-
Phosphoric acid	-	13598-36-2	-
Bromine	-	07726-95-6	-
2-chloroethanol	-	00107-07-3	-
Methyl chloride	-	00074-87-3	-
1,2-dichloroethane	-	00107-07-3	-
1,2-dichloropropane	-	00078-87-5	-

INTERNATIONAL CENOLOGICAL CODEX

Cation Exchange Resins

COEI-1-RESECA: 2000

3-(dimethylamino)propane - 03179-63-3 -

NAME PM/REF CASE RESTRICTIONS

Monomers and other starting substances

Methylic chloromethyl ether	-	00107-30-2	-
Nitrobenzene	-	00098-95-3	-
Potassium nitrite	-	07758-09-0	-
Phthalimide	-	0085-41-6	-
Sulfur trioxide	-	07446-11-9	-
Trimethylamine	-	00075-50-3	-

Polymerization additives

Lignosulfonic acid	63940	08062-15-5	-
Peracetic acid	-	00079-21-0	-
Polyacrylic acid	76460	09003-01-4	-
Poly(styrenesulfonic) acid	-	09080-79-9	-
Acrylamide/acrylic acid copolymer	-	09003-06-9	-
Ethoxylated, propoxylated tert-alkylamines (C ₁₂ -C ₁₄)	-	68603-58-7	-
Maleic anhydride-styrene copolymer, ammonium salt	-	26022-09-3	-
Attapulgite	-	12174-11-7	-
Azobisisobutyronitrile	-	00078-67-1	-
1,1-bis(tert-butylperoxy)-3,3,5-trimethylcyclohexane	-	06731-36-8	-
n-Dodecyl mercaptan	-	25103-58-6	-
Poly(ethylene/propylene)glycol monobutyl ester	-	09038-95-3	-
Polyethylene glycol octylphenyl ether	78560	09002-93-1	-
Poly(ethylene-propylene)glycol ether with 1,1,1-trimethylol-propane	-	52624-57-4	-
tert-hexadecyl mercaptan	-	25360-09-2	-
Cumyl hydroperoxide	-	00080-15-9	-
Isododecane	62405	31807-55-3	-
Isooctane	-	26635-64-3	-
Mono- and dialkyl (C ₁₀ -C ₁₈) Sulfonamides	-	-	-
Silver nitrate	-	07761-88-8	-
n-Octane	-	00111-65-9	-
tert-Butyl peracetate	-	00107-71-1	-
tert-Butyl perbenzoate	-	00614-45-9	-
bis(4-tert-butylcyclohexyl)percarbonate tert-Butyl per(2-ethyl-hexanoate)	-	03006-82-6	-
tert-Butyl peroctanoate	-	13467-82-8	-
Dilauroyl peroxide	-	00105-74-8	-
Poly(diallyldimethylammonium chloride)	-	26062-79-3	-
Polyvinylpyrrolidone	81500	09003-39-8	-

OENOLOGICAL CARBON**INS N°: 153**

OENO 7/2007;

OIV-OENO 604-2018

1. OBJECT, ORIGIN AND FIELD OF APPLICATION

Oenological carbon are of plant (generally wood) origin. In order to increase their adsorption properties, the carbon is subjected to activation either at a high temperature or a lower temperature in the presence of an acid, (generally phosphoric acid). Oenological carbon must not be activated with a metal-based catalyser like zinc chloride.

It is in the form of very fine and light black powder, or in granulated form.

There are humid preparations which can reduce dust accumulation. In this case, weight loss as described in 3.1 can reach 60%.

Carbon can be agglomerated with bentonite.

Carbon for oenological purposes is used to correct alterations due to fungus in addition to the colour of white musts from purple, spotted or oxidised grapes. The carbon can eliminate anthocyanins and oxidised or non-oxidised polyphenols in addition to polysaccharides. The carbon are used to correct the organoleptic characteristics of musts made from grapes altered by fungus.

Oenological carbon can also be used to reduce the presence of Ochratoxin A in musts, the musts during fermentation and in white wine.

Decolourising carbon has a relatively weak deodorising effect.

Absorption by carbon is not very selective and depends on its structure, porosity and specific surface area.

The limit concerning the use of carbons should be compliant with the prescriptions of the OIV International Code of Oenological Practices (expressed by weight of dry carbon).

2. LABELLING

The label should indicate the storage conditions, the expiration date for humid solutions, and a mention of whether there are existing regulations regarding the usage of the product and specify if it concerns decolourising or deodorising carbon.

3. TEST TRIALS**3.1 Loss with dessication**

Put 5g of carbon in a silica capsule and heat to 100°C in an incubator.

After 3 hours of dessicating, weight loss should not be more than 20%.

All limits set for carbon refer to dry carbon weight.

3.2 Ashes

Incinerate the previously obtained dry residue at 500°C-600°C. These ashes should not be more than 10%. Carbon agglomerated with bentonite should have ashes more than 10% and less than 30%.

3.3 Soluble matter in acids

Boil 5 g of dried carbon with 20 ml of concentrated hydrochloric acid (R) and 100 ml of water. Once cooled, filter using a fine filter or membrane. Evaporate the filtrate and dry at 100°C–105°C. The soluble matter content in acids should not be more than 5%.

3.4 Chlorides

Shake 0.067g of dried carbon and 20 ml of distilled water. Filter. Add 5 ml of diluted nitric acid (R) to 5 ml of filtrate. Fill up to 20 ml and add 0.5 ml of silver nitrate solution at 5% (R).

Compare any opalescence or cloudiness to a prepared control sample as indicated in the annex. Other methods such as ionic chromatography can be used.

Chloride content should not be more than 3g/kg.

3.5 Cyanides

Put a quantity of carbon containing 1 g of dried carbon with 10 ml of diluted sulphuric acid (R) in a 100 ml conical flask. Adapt to the conical flask a pressure relief tube plunged into approximately 2 ml of saturated borax solution (R) in a test tube. Distil and gather 2 to 3 ml of distillate. Add 5 drops of potassium anhydrosulphite solution at 2% (R) and leave for 5 minutes. Add 1 ml of iron sulphate solution (II) at 5% (R) and leave for 15 minutes. Then add 2 drops of phenolphthalein (R). Use a saturated borax solution (R) to make the solution a little more alkaline. Leave for 5 minutes. Add 2 drops of iron sulphate (III) and ammonia solution at 10% (R) and 1 ml of concentrated hydrochloric acid (R). No colouration nor blue precipitate should form.

3.6 Polycyclic aromatic hydrocarbons

Polycyclic aromatic hydrocarbons including benzo[a]pyrene are extracted by hexane; the solvent is evaporated and the residue is taken by the methanoltetrahydrofuran mixture for HPLC analysis following the method described in chapter II.

NOTE: It is also possible to determine benzo[a]pyrene by gas chromatography by using an apolar capillary column with detection by mass spectrometry following the method described in chapter II of the

International Oenological Codex.

Benzo[a]pyrene content should not be more than 10 µg/kg.

3.7 Sulphides

Put a quantity of carbon containing 1 g of dried carbon with 10 ml of diluted hydrochloric acid and 10 ml of water in a 50 ml flask.

Distil and collect 5 ml of distillate in a test tube containing 5 ml of 1 M sodium hydroxide solution.

0.5 ml of lead nitrate solution at 1 g per litre (R) is added to 1 ml of test trial solution. There should be no brown colouring or black precipitate. Sulphide content expressed in sulphur should not be more than 20 mg/kg.

3.8 Preparation of test trial solution

Put a quantity of carbon corresponding to 2.5 g of dried carbon with 50 ml of a citric acid solution at 5 g a litre with a pH of 3 (R), in a conical flask with a wide opening that can be sealed. Shake vigorously for 5 minutes and allow to stand at least 12 hours. Filter through a fine filter or a membrane in order to obtain a clear solution.

3.9 Iron

Add 5 ml of water, 1 ml of concentrated hydrochloric acid, 2 ml of 5% potassium thiocyanate solution (R) to 5 ml of test trial solution as prepared in point 3.8. The colouration obtained should be lighter than the control sample prepared with 10 ml of iron salt solution (II) at 0.010 g of iron per litre (R), and 1 ml of concentrated hydrochloric acid (R), 2 ml of 5% potassium thiocyanate solution (R). Atomic absorption spectrophotometry can also be used.

Iron content should not be more than 200 mg/kg.

3.10 Lead

Determine the lead according to the method described in chapter II on the test trial solution prepared according to point 3.8.

Lead content should not be more than 2 mg/kg.

3.11 Mercury

Determine the mercury according to the method described in chapter II on the test trial solution prepared according to point 3.8.

Mercury content should not be more than 1 mg/kg.

3.12 Arsenic

Determine the arsenic according to the method described in chapter II on the test trial solution prepared according to point 3.8.

Arsenic content should not be more than 3 mg/kg.

3.13 Calcium

Determine the calcium according to the method described in chapter II on the test trial solution prepared according to point 3.8.

Calcium content should not be more than 10 g/kg.

3.14 Cadmium

Determine cadmium according to the method described in chapter II on the test trial solution prepared according to point 3.8.

Cadmium content should not be more than 1 mg/kg.

3.15 Zinc

Determine the zinc according to the method described in chapter II on the test trial solution prepared according to point 3.8.

Zinc content should not be more than 25 mg/kg.

3.16 Specific surface area

The specific surface area of a decolourising carbon must be between 600 and 2000 m²/g.

Methylene blue decolourisation is the method used. (Methylene blue indicator).

3.17 Methylene blue indicator

Prepare 4 conical flasks and place 0.1 g of carbon.

Add 10, 15, 17 and 20 ml of methylene blue solution at 1.2 g/l (absorbance at 620 nm is between 0.830 and 0.850).

After shaking for 5 minutes, filter through a slow filter and note the volume of the solution in the conical flask which underwent decolourisation.

Depending on the results, repeat this experiment with different volumes of solution.

Put the solution in a spectrophotometer at 664 nm with the absorbance value of 0.08 with an optical path of 1 cm.

The volume of the methylene blue test solution in ml just discoloured, represents the methylene blue indicator.

4 PHENOL INDEX**4.1. Introduction**

When activated carbon is applied in the treatment of wine, the phenol index can be used to define a limit value over which the carbon is considered as a decolouriser

and under which it is regarded as a deodoriser. The phenol index selected is the AWWA B600-90 index

4.2 Principle:

AWWA phenol index: this index, expressed in g of carbon scaled to the dry weight per l of solution represents the carbon powder concentration required to decrease the phenol concentration of a solution from 200 mg/l to 20 mg/l.

4.3 Description of the AWWA method:

This index is determined using an adsorption isotherm based on at least 4 different weights of carbon put in contact with a phenol solution.

This isotherm represents the weight of phenol adsorbed in mg/l/g carbon, in relation to the residual phenol concentration in the solution, expressed in mg/l.

4.4 Reagents

4.4.1 Pure disodic hydrogenophosphate Na_2HPO_4 for analysis

4.4.2 Distilled water

4.4.3 Pure phosphoric Acid (H_3PO_4)

4.4.4 Pure phenol

4.4.5 Buffer solution A of disodic hydrogenophosphate with a pH of 6.5 at 104 g/l

In a 1-litre graduated flask, dissolve 104 g of disodic hydrogenophosphate (4.4.1) in 300 ml of hot water (4.4.2), add 14 ml of phosphoric acid (4.4.3) and make up to one litre. Homogenise. Check that the pH is 6.5 ± 0.1

4.4.6 Buffer solution B of disodic hydrogenophosphate with a pH of 6.5 at 10.4 g/l

In a 1-litre graduated flask, place 100 ml of buffer solution A at 104 g/l (4.4.5) and make up with water (4.4.2). Homogenise.

4.4.7 Phenol solution with 1 g/l

In a 100-ml graduated flask, place 100 mg of phenol (4.4.4) and make up to 100 ml with water (4.4.2). Obtain complete dissolution by stirring.

4.4.8 Calibration solutions of phenol with 20, 40, 60, 80, 100, and 120 mg/l

In a series of 100-ml graduated flasks, respectively place 2 ml, 4 ml, 6 ml, 8 ml, 10 ml, and 12 ml of the phenol solution with 1 g/l (4.4.7). Make up to 100 ml using buffer solution B (4.4.6).

4.4.9 Phenol solutions with 200 mg/l

In a 1-litre flask, place 200 ml of the phenol solution at 1 g/l (4.4.7), add 100 ml of buffer solution A (4.4.5), make up to 1 l with water (4.4.2). Homogenise.

4.4.10 Measuring the phenol index of oenological carbon powder

Note The water content of the carbon must be known in order to scale the index to the dry carbon weight.

4.5 Apparatus

4.5.1 Laboratory glassware i.e.: graduated precision pipettes to measure small volumes, 100-ml and 1-l graduated flasks, funnels, and 300-ml conical bottles

4.5.2 Filter paper

4.5.3 Laboratory balance, precision to within 0.10 mg

4.5.4 Spectrometer capable of operating in the ultraviolet spectrum and housing quartz tanks with an optical thickness of 1 cm.

4.5.5 Laboratory shaker (it is not recommended to use a magnetic bar)

4.6 Procedure

4.6.1 Phenol calibration curve.

Measure the absorbance at 270 nm in tanks with an optical thickness of 1 cm (4.5.4) of each phenol solution with 20, 40, 60, 80, 100, and 120 mg/l (4.4.8). Calculate the straight regression line of the absorbance in relation to the phenol concentration.

Note The blank is based on buffer solution B (4.4.6).

4.6.2 Determine the residual phenol for each carbon (4.4.10)

In a series of 300-ml conical flasks, place 200 ml of phenol solution at 200 mg/l (4.4.9), then respectively 0.4, 0.5, 0.6 and 0.7 g of carbon; close the bottle.

For these 4 preparations, stir for 30 minutes (4.5.5) so that the carbon remains in suspension.

Filter on paper (4.5.2) the 4 samples containing the carbon and a blank (phenol solution with 200 mg/l (4.4.8) without carbon).

Measure the absorbance at 270 nm in tanks with an optical thickness of 1 cm (4.5.4) of each one of the filtered solutions.

Note 1 The blank is based on buffer solution B (4.4.6).

Note 2 At least one of the quantities of carbon must adsorb 90% of the phenol in the solution; if not, widen the carbon weight range.

4.7 Calculations

4.7.1 Determine the percentage of residual phenol in each filtrate for each activated carbon: residual % = milligram per litre of residual phenol filtrate * 100/200 (milligram per litre of phenol in the test solution). **i.e. a = %** residual phenol

4.7.2 Determine the percentage of X (adsorbed phenol)

% of X = 100 - % residual in the filtrate. **i.e. X = 100 - a**

4.7.3 The quantities of activated carbon for 200 ml of phenol solution are multiplied by 5 to obtain the quantities of activated carbon, **i.e. M** in grams per litre.

4.7.4 Calculate the percentage of the value of **X/M** for each activated carbon.

4.7.5 Plot the isotherm: percentage of residual normality of the filtrate on the X-axis (a) and the percentage of X/M on the Y-axis using 2x2 logarithmic paper; establish the straight regression line and determine the regression equation. It is also possible to calculate the regression using the logarithm for the values of a and X/M.

4.7.6 Determine X/M at 10%; **i.e. C** (when the residual phenol concentration of the filtrate is 10%).

4.7.7 **Phenol index** in grams per litre = $90/C * (100 - \% \text{ of humidity}/100)$; **i.e. P**

This formula refers to activated carbon without humidity.

4.7.8 Limit values

A carbon is regarded as a deodouriser if its phenol index is lower than 3.5

4.7.9 Examples

Standard curve	Phenol
Abs at 270 nm	mg/l
0.303	20
0.603	40
0.8777	60
1.3443	100
1.53	120

Calibration straight line for phenol titration

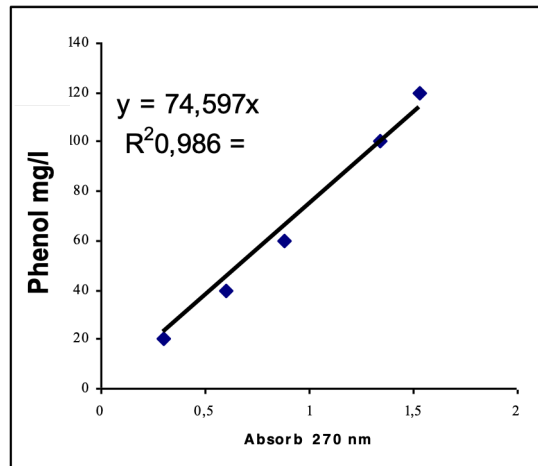

A1	g of carbon	% humidity	Dry weight	Abs	C phenol
	0.25	1.31	0.2467	0.309	23
	0.6255	1.31	0.6173	0.065	5
	0.7136	1.31	0.7043	0.0454	3
	0.7829	1.31	0.7726	0.0367	3

A1 Calculations

a	X	M	a	X/M	Log a	Log X/M
11.53	88.47	1.23	11.53	71.72	1.061829	1.855636
2.42	97.58	3.09	2.42	31.61	0.384605	1.499871
1.69	98.31	3.52	1.69	27.92	0.228747	1.445885
1.37	98.63	3.86	1.37	25.53	0.136357	1.407065
		c				P
		10.00		66.16	1	1.8206 1.3

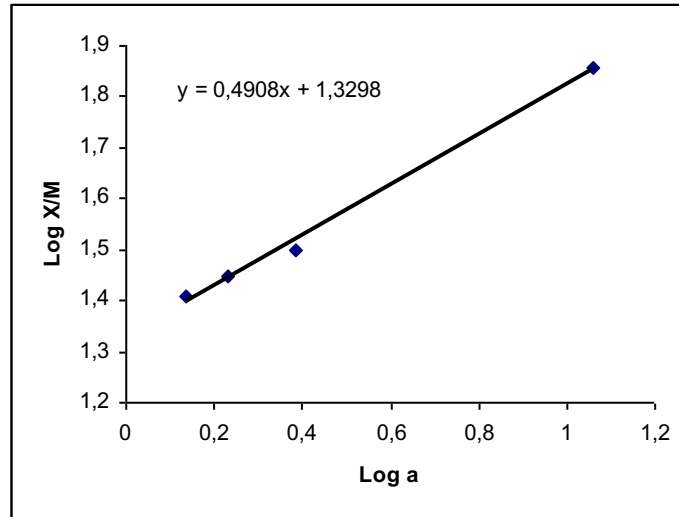

Adsorption isotherm of carbon A1

A2	g of carbon	% Humidity	Dry weight	Abs	C phenol
	0.4054	1.60	0.3989	0.9969	74
	0.6012	1.60	0.5916	0.679	51
	0.7914	1.60	0.7787	0.4972	37
	0.9032	1.60	0.8887	0.4126	31
	1.4040	1.60	1.3815	0.2654	20

A2 Calculations

a	X	M	a	X/M	Log a	Log X/M
37.18	62.82	1.99	37.18	31.49	1.570343	1.498241
25.33	74.67	2.96	25.33	25.25	1.403561	1.402199
18.54	81.46	3.89	18.54	20.92	1.268222	1.320569
15.39	84.61	4.44	15.39	19.04	1.187221	1.279687
9.90	90.10	6.91	9.90	13.04	0.995635	1.115409
			c			P
			10	13.70	1	1.1367 6.5

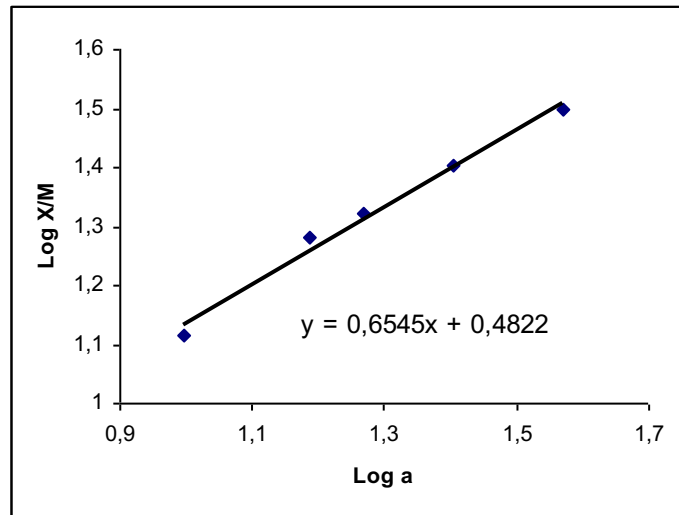

Adsorption isotherm of carbon A2

4.7.10 Collaborative analysis: AWWA phenol indices in g/l

	Lab 1	Lab 2	Lab 3	Lab 4
A1	1.7	1.53	1.8	1.3
A2	5.1	4.56	6.2	6.5
A3	1.3	1.29	1.8	1.4
A4	5.8	4.95	10.0	7
B1	11.4	7.18	10.6	7.6
B2	1.8	1.47	2.3	1.4
B3	49.4	21.97	18.0	17.5
B4	2.9	2.80	3.6	2.6
C1	1.9	1.69	2.3	1.8
C2	1.7	1.56	2.0	1.5
C3	5.4	4.71	6.2	4.9
C4	5.4	4.55	6.0	4.7

Reproducibility: 2.88 for the 5.86 general average SR = 1,03

5. DETERMINATION OF THE DECOLOURISATION CAPACITY OF CARBON**5.1 Principle**

Measuring the decolourisation of an oenocyanin solution with a precise amount of carbon under defined conditions.

5.2 Apparatus:

Equipment:

5.2.1 Precision balance in mg

5.2.2 Magnetic stirrer

5.2.3 Absorption spectrophotometer for OD to 420, 520 and 620 nm
measures Glassware:

5.2.4 250 ml cylindrical flask

5.2.5 250 ml conical flask

5.2.6 200 ml volumetric flask

5.2.7 Chamber with a 1 mm optical path for an absorption spectrophotometer.

5.3 Reagents

5.3.1 Very pure demineralised water

5.3.2 Crystallised acetic acid

5.3.3 Tartaric acid

5.3.4 Crystallised sodium acetate

5.3.5 96% volume ethanol

5.3.6 Oenocyanin powder

5.4 Preparation of oenocyanin solution

5.4.1 Pour approximately 150 ml of demineralised water (5.3.1) in a 250 ml cylindrical flask (5.2.4).

5.4.2 Shake (5.2.2).

5.4.3 Weigh $0.900 \text{ g} \pm 0.001 \text{ g}$ of oenocyanin (5.3.6) and dissolve by adding small amounts while stirring in a vortex mixer.

5.4.4 Weigh $1.400 \text{ g} \pm 0.01 \text{ g}$ of tartaric acid (5.3.3) and pour into the cylindrical flask (5.2.4).

5.4.5 Pour 0.8 ml of crystallised acetic acid (5.3.2) and 1.4 g of crystallised sodium acetate (5.3.4).

5.4.6 Shake continuously until completely dissolved (5.2.2)

5.4.7 Transfer to a 200 ml volumetric flask (5.2.6).

5.4.8 Adjust to 200 ml with the rinsing water from the cylindrical flask of the 5.4 preparation.

5.4.9 Transfer again into a 250 ml cylindrical flask (5.2.4).

5.4.10 Shake (5.2.2).

5.4.11 Centrifuge 150 ml of the solution for 10 minutes at 10,000 g place the supernatant in a cuvette with 1 mm optical path

5.4.12 Measure the colour intensity of the spectrometer (5.2.3)

$$CI1 = OD 420 + OD 520 + OD 620$$

$$CI1 = 4 \pm 0.3$$

5.5 Decolourisation by carbon

5.5.1 Weigh 100 mg of dried carbon.

(Measure the humidity in order to define the exact dose of humid carbon to be used).

5.5.2 Put the carbon in 100 ml of oenocyanin solution with colour intensity

$$CI 1 = 4 \pm 0.3$$

5.5.3 Shake for 30 minutes (5.2.2).

5.5.4 Allow to stand for 10 minutes and centrifuge 10 ml of this mixture for 10 minutes at 10,000 g.

5.5.5 Measure the colour intensity with a spectrometer (5.2.3) under 1 mm of optical path:

$$CI 2 = OD 420 + OD 520 + OD 620$$

5.6 Calculation of decolourisation capacity

The decolourisation capacity (DC): $DC = 100 (CI1 - CI2) / CI1$

Carbon is considered as a 'decolourising agent' when DC is more than or equal to 40.

6. STORAGE

Carbon cannot be stored in open bags because of its adsorption capacities. Oenological carbon must be stored in sealed packages away from volatile substances that it could adsorb.

**CARBOXYMETHYLCELLULOSE
(cellulose gum)****(CMC)****INS no. 466****CAS [9004-32-4]**

OIV/OENO 366/2009

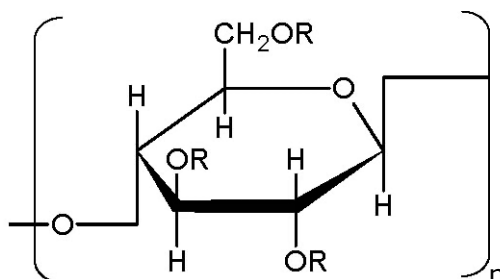

where R = H or CH₂COONa

1. SUBJECT, ORIGIN AND SCOPE

Carboxymethylcellulose (cellulose gum) for oenological use is prepared exclusively from wood by treatment with **alkali** and monochloroacetic acid or its sodium salt. Carboxymethylcellulose inhibits tartaric precipitation through a "protective colloid" effect. A limited dose is used.

2. SYNONYMS

Cellulose gum, CMC, Sodium CMC, Sodium salt of a carboxymethyl ether of cellulose, NaCMC

3. LABELLING

Labelling must mention that the carboxymethylcellulose is for use in food, as well as safety and preservation conditions.

4. CHARACTERISTICS**4.1 Description**

Granular or fibrous powder, blank or slightly yellowish or greyish, slightly hygroscopic, odourless and tasteless. This may be proposed in

the form of a concentrate for solution in wine prior to use. Solutions must contain at least 3,5 % carboxymethylcellulose.

4.2 Chemical formula

The polymers contain anhydroglucose units substituted with the following general formula: $[C_6H_7O_2(OH)_x(OCH_2COONa)_y]_n$ where N is the degree of polymerisation

x = from 1.50 to 2.80

y = from 0.2 to 1.50

x + y = 3.0

(y = degree of substitution)

Note: Only the carboxymethylcellulose possessing a degree of substitution between 0.6 and 1.0 are completely soluble.

4.3 Degree of substitution

Evaluate the degree of substitution using the method described below. The degree of substitution must lie between 0.60 and 0.95.

4.4 Molecular weight

Ranges from 17,000 to 300,000 (degree of polymerisation from 80 to 1,500). The molecular weight can be evaluated through measurement of viscosity.

The viscosity of a 1 % solution must lie between 10 and 15 $mPa \cdot s^{-1}$, or between 20 and 45 $mPa \cdot s^{-1}$ for a 2 % solution, or between 200 and 500 $mPa \cdot s^{-1}$ for a 4 % solution.

4.5 Composition

Measure the carboxymethylcellulose composition using the method described below. The carboxymethylcellulose content must be at least 99.5 % of the anhydrous substance.

5. TESTS

5.1 Solubility

Forms viscous colloidal solution with water. Insoluble in ethanol.

5.2 Foam test

Vigorously shake a 0.1 % solution of the sample. No layer of foam appears (this test distinguishes sodium carboxymethylcellulose from other cellulose ethers and from alginates and natural gums).

5.3 Precipitate Formation

To 5 mL of an 0.5% solution of the sample add 5 mL of a 5 % solution of copper sulfate or of aluminium sulfate. No precipitate appears. (This test permits the distinction of sodium carboxymethyl cellulose ethers from other cellulose ethers, and from gelatine, carob bean gum and tragacanth gum)

5.4 Colour reaction

Add 0.5 g of powdered carboxymethylcellulose sodium to 50 mL of water, while stirring to produce a uniform dispersion. Continue the stirring until a clear solution is produced. To 1 mL of the solution, diluted with an equal volume of water, in a small test tube, add 5 drops of 1-naphthol. Incline the test tube, and carefully introduce down the side of the tube 2 mL of sulfuric acid so that it forms a lower layer. A red-purple colour develops at the interface.

5.5 Moisture - Loss on drying

Measure the loss on drying using the method described below. Not more than 12 % after drying.

5.6 pH of a 1 % solution

No less than 6 and no more than 8.5 pH units.

5.7 Arsenic

Quantify the arsenic using the method described in chapter II. The arsenic content must be lower than 3 mg/kg

5.8 Lead

Quantify the lead using the method described in chapter II. The lead content must be lower than 2 mg/kg

5.9 Mercury

Quantify the mercury using the method described in chapter II. The mercury content must be lower than 1 mg/kg

5.10 Cadmium

Quantify the cadmium using the method described in chapter II. The cadmium content must be lower than 1 mg/kg

5.11 Free Glycolate

Quantify the glycolate using the method described below. The carboxymethylcellulose should not contain more than 0.4 % (calculated in sodium glycolate percentage of the anhydrous substance).

5.12 Sodium

Quantify the sodium using the method described in chapter II. The sodium content must be lower than 12.4 % of the anhydrous substance

5.13 Sodium chloride

Quantify the sodium chloride using the method described below. The carboxymethylcellulose must not contain more than 0.5 % of the anhydrous substance.

ANNEXES**1 Loss on drying**1.1 Objective

This test determines the volatile part of carboxymethylcellulose. The result of this test is used to calculate the total solids of the sample and by extension, all the volatile substances at the test temperature are regarded as moisture.

1.2 Interest and use The measurement of water content (by taking account of the purity) is used to measure the quantity of carboxymethylcellulose in commercial products.

1.3 Equipment

1.3.1 Drying oven at $105\text{ °C} \pm 3\text{ °C}$;

1.3.2 Weighing bottle 50 mm in internal diameter and 30 mm in height or equivalent;

1.3.2 Precision balance

1.4 Test

1.4.1 Weigh between 3 and 5 g of sample to $\pm 1\text{ mg}$, in a weighing bottle which has already been tared.

1.4.2 Place the weighing bottle without its lid in the drying oven for four hours. Let cool in a desiccator, replace the lid and weigh.

1.4.3 Continue the process until constant weight

1.5 Calculation

1.5.1 Calculate the percentage of the water content M according to the formula:

$M = (A/B) \times 100$ where

A = loss of weight by drying (in g); B = initial mass of sample.

2 Sodium Glycolate

2.1. Objective

This test covers the determination of sodium glycolate contained in the purified carboxymethylcellulose containing not more than 2 % sodium glycolate.

2.2 Summary of the test method

Carboxymethyl cellulose dissolved in acetic acid (50 %), precipitated with acetone in the presence of sodium chloride and the insoluble is eliminated by filtration. The filtrate containing the glycolate sodium (in the form of glycolic acid) is treated to remove the acetone and reacts with 2,7-dihydroxynaphthalene. The resulting colour is measured at 540 nm with a calibrated spectrophotometer using solutions of known concentrations.

2.3 Interest and use

This test method (along with moisture and sodium chloride) is must be used when measuring the quantity of polymer in the substance. It must be used to check the purity of carboxymethylcellulose required by public health regulations.

2.4 Equipment

2.4.1 Spectrophotometer capable of carrying out analysis at 540 nm;

2.4.2 Spectrophotometer cells, 1 cm of optical path

2.4.3 Aluminium paper in squares approximately 50 × 50 mm;

2.4.4 Precision balance

2.5 Reagents

2.5.1 Acetic acid, glacial (purity ≥ 99 %);

2.5.2 Acetone (purity ≥ 99 %);

2.5.3 2,7-dihydroxynaphthalene solution (0.100 g/L): Dissolve 100 mg ± 1 mg of 2,7-dihydroxynaphthalene (naphthalenediol) in 1 L of sulphuric

acid. Before using, allow the solution to stand until the initial yellow color disappears. If the solution is dark, eliminate it and prepare a new one with a different supply of sulphuric acid. This solution remains stable for one month when stored in a dark bottle;

2.5.4 Standard glycolic acid solution at 1 mg/mL: dry several grams of glycolic acid in a desiccator for at least sixteen hours at room temperature. Weigh $100 \text{ mg} \pm 1 \text{ mg}$, pour into a 100 mL graduated flask, dissolve with water, adjust with water to the filling mark. Do not keep solution longer than 30 days;

2.5.5 Sodium chloride (NaCl, purity $\geq 99 \%$);

2.5.6 Sulphuric acid concentrate (H_2SO_4 purity $\geq 98 \%$, $\rho \geq 1.84$).

2.6 Preparation of the calibration curve

2.6.1 In a series of five graduated 100 mL volumetric flasks, pour 0, 1, 2, 3 and 4 mL of the glycolic acid reference solution (to 1 mg / mL). Into each flask, add 5 mL of water, then 5 mL of glacial acetic acid, make up with acetone to the filling mark and mix. These flasks contain respectively, 0, 1, 2, 3 and 4 mg of glycolic acid.

2.6.2 Pipet 2 mL of each of these solutions and transfer them into five 25 mL graduated flasks. Evaporate the acetone by heating the open graduated flasks, laid out vertically, in a water bath for exactly 20 min. Remove from the water bath and let cool at room temperature.

2.6.3 Add 5 mL of 0.100 g/L 2,7-dihydroxynaphthalene solution, mix thoroughly, then add an additional 15 mL of 2,7-dihydroxynaphthalene solution and mix. Cover the mouth of the flasks with a small piece of aluminium foil, place the flasks upright in the water bath for 20 min. Remove from the water bath, let cool at room temperature and add sulphuric acid to the filling mark.

2.6.4 Measure the absorbance of each sample at 540 nm against the blank using 1 cm optical depth cells. Plot the absorbance curve according to the corresponding quantity of glycolic acid (in mg) in each flask.

2.7 Test method

2.7.1 Weigh $0.500 \text{ g} \pm 0.001 \text{ g}$ of sample and transfer into a 100 mL beaker. Moisten the sample entirely with 5 mL of acetic acid, followed by 5 mL of water, stir with a glass rod until dissolution is complete (usually requires approximately 15 minutes). Slowly add 50 mL of acetone while stirring, then approximately 1 g of sodium sulphate. Continue to stir for

several minutes to ensure complete completely precipitation the carboxymethylcellulose.

2.7.2 Filter using a paper filter previously soaked with small amount of acetone, and collect the filtrate in a 100 mL graduated flask. Use 30 mL of acetone to facilitate transfer of solid matter and to wash the filter cake. Make up to the filling mark with acetone and mix.

2.7.3 In another 100 mL graduated flask, prepare a blank with 5 mL of water, 5 mL of glacial acetic acid, then make up to the filling mark with acetone and mix.

2.7.4 Pipet 2 mL of the sample solution and 2 mL of the blank solution and pour them into two 25 mL graduated flasks. Evaporate the acetone as before (2.6.2).

2.7.5 Measure the absorbance of the sample and infer the quantity of glycolic acid (in mg) using the calibration curve (2.6.4).

2.8 Calculation: Calculate the content C (in %) of sodium glycolate (free glycolate) contained using the formula:

$$C(\% \text{ sodium glycolate}) = \frac{B \times 0.129}{W \times (100 - M)}$$

where

B = glycolic acid (in mg) inferred using the calibration curve;

W = quantity of weighed carboxymethylcellulose (in g);

M = water content of the sample (in %);

0.129 = (ratio of the molecular weight of sodium glycolate compared to the molecular weight of the glycolic acid)/10.

Note: if the test is carried out with pre-dehydrated carboxymethylcellulose, the formula becomes:

$$C(\% \text{ sodium glycolate}) = \frac{B \times 0.129}{W}$$

W = quantity of carboxymethylcellulose (dry) weighed (in g).

3 Sodium chloride

3.1 Objective This test method determines the sodium chloride content of the purified carboxymethylcellulose (> 98 %).

3.2 Summary of the test method The sodium carboxymethylcellulose is dissolved in water and titrated by potentiometry with a silver nitrate solution. Hydrogen peroxide is added to reduce the viscosity of the solution.

3.3 Importance and use This test method (along with moisture and sodium glycolate content) is used to calculate the degree of substitution of carboxymethylcellulose. It must be used to analyse highly purified grades of sodium carboxymethylcellulose (> 98 %).

3.4 Equipment

3.4.1 pH-meter capable of reading voltage (in mV), equipped with a silver electrode and a mercury sulphate reference electrode saturated with potassium sulphate.

3.4.2 buret, 10 mL

3.4.3 Precision balance.

3.4.4 250 mL Erlenmeyer flask.

3.5. Reagents

3.5.1 Concentrated hydrogen peroxide (30 % in mV) (H₂O₂).

3.5.2 Concentrated nitric acid (HNO₃) (ρ 1.42).

3.5.3 Silver nitrate, standard solution (0.1 N) - Dissolve 17.0 g of silver nitrate (AgNO₃) in 1 L of water. Store in an amber glass bottle. Standardise the solution as follows: Dry the sodium chloride (NaCl) for 2 hrs at 120 °C. Weigh 0.65 g ± 0.0001 g in a 250 mL beaker and add 100 mL of water. Place on a magnetic stirrer, add 10 mL of HNO₃, and immerse the electrodes of the pH-meter. Using a buret, add by 0.25 mL fractions the theoretical quantity of the AgNO₃ solution. After each addition, wait approximately 30 seconds before carrying out readings of the corresponding voltages. When approaching the endpoint, decrease the additions to 0.05 mL. Record the voltage (in millivolts) according to the volume (in mL) of the titration solution, continue titration a few mL beyond the endpoint. Trace the potential values obtained in relation to the corresponding volumes of titrated solution, and determine the potential of the equivalence point according to the singular point of the curve obtained.

Calculate the normality, N, as follows:

$$N = (A \times 1000) / (B \times 58,45)$$

where

A = NaCl used in g,

B = added AgNO₃ solution in mL,

58.45 = molecular mass of the NaCl in g,

3.5.4 Sodium chloride (NaCl, purity ≥ 99%).

3.6 Test method

3.6.1 Weigh 5 g ± 0.0001 g of sample in a 250 mL beaker. Add 50 mL of water and 5 mL of H₂O₂ (30 %). Place the beaker on a steam bath, stirring occasionally until the solution is fluid. If dissolution does not occur within 20 min, add 5 mL of H₂O₂ and heat until dissolution is complete.

3.6.2 Cool the beaker, add 100 mL of water and 10 mL of HNO₃. Place it on the magnetic stirrer and titrate with the 0.1 N AgNO₃ solution (3.5.3) up to the equivalence point.

3.7 Calculation

3.7. 1 Calculate the sodium chloride content C (in %) as follows:

$$C = (AN \times 584,5) / [G \times (100 - B)]$$

Where:

A = volume of AgNO₃ solution added (in mL);

N = Normality of the AgNO₃ solution;

G = weight of the sample used (in g),

B = Moisture, given extemporaneously (in %) as per paragraph 1 and

584.5 = molecular

mass of NaCl ×10 (in g).

4 Degree of substitution

4.1 Objective This method is used to determine the degree of etherification (of substitution) of the carboxymethylcellulose used.

4.2 Summary of the test method Pre-purified carboxymethylcellulose mineralises in the presence of sulphuric acid. The weight of the residual sodium sulphate enables inference of the sodium content and by extension the degree of substitution.

4.3 Importance and use This test method is used to determine the number of substituent groups added to the basic cellulose backbone.

4.4 Equipment

4.4.1 500 mL Erlenmeyer flask.

4.4.2 Precision balance.

4.4.3 Sintered glass filter.

4.4.4 Filter-flask.

4.4.5 Porcelain crucible.

4.4.6 Drying oven at 110 °C.

4.4.7 Desiccator.

4.4.8 Bunsen burner or muffle furnace at 600 °C.

4.5 Reagents

4.5.1 Methanol or ethanol (purity \geq 98 %)

4.5.2 0.1 N silver nitrate (AgNO_3)

4.5.3 Acetone (purity \geq 99 %)

4.5.4 Sulphuric acid (purity \geq 96 %)

4.5.5 Ammonium carbonate (NH_4HCO_3)

4.6 Preparation of the sample (This step is not necessary if the sample is assumed to contain at least 99.5 % of of carboxymethylcellulose) Weigh 5 g of the sample \pm 0.1 mg, and transfer into a 500 mL conical flask. Add 350 mL of methanol or ethanol (80 % volume). Stir the suspension for 30 min. Decant through a tared glass filtering crucible under gentle suction. At the end of filtration, avoid drawing in air through the crucible. Repeat the treatment until the 0.1 N silver nitrate test for the chloride ions is negative for the crucible. Normally, three washings sufficient. Transfer the carboxymethylcellulose into the same crucible. Eliminate the traces of alcohol by rinsing with acetone. Let the acetone evaporate into the air (under a hood) then in a drying oven at 110 °C until constant weight. Weigh for the first time after two hours. Cool the crucible each time in a desiccator and during the weighing, pay attention to the fact that sodium carboxymethyl cellulose is slightly hygroscopic.

4.7 Test method In a porcelain crucible tared beforehand, weigh 2 g \pm 0.1 mg of dried substance following the preparation above. Char with the Bunsen burner, first carefully with a small flame and then for 10 min with a large flame. Cool, then pour 3 to 5 mL of concentrated sulphuric acid onto the residue. Heat carefully with the fuming is finished. After

cooling, add about 1 g of ammonium carbonate by pouring the powder onto the entire contents of the crucible. Reheat, initially with a small flame until no more smoke is released then at deep red for 10 min.

Repeat the sulphuric acid and ammonium carbonate washing if the residual sodium sulphate still contains carbon. Let the crucible cool in a desiccator and weigh. In place of adding the ammonium carbonate and heating by flame, the crucible can be placed in an oven for one hour at approximately 600 °C.

4.8 Calculate the sodium content of the sample extracted from alcohol by the formula

$$\% \text{ sodium} = \frac{a \times 32.38}{b}$$

a = weight of residual sodium sulphate

b = weight of the sample extracted from dry alcohol

4.9 Calculate the degree of substitution using the formula:

$$\text{Degré de substitution} = \frac{162 \times \% \text{ sodium}}{2300 - (80 \times \% \text{ sodium})}$$

5 Composition in carboxymethyl cellulose

Calculate the percentage of sodium carboxymethyl cellulose in the sample by deducting 100 % of the sum of percentages of sodium and sodium glycolate (free glycolate), determined separately by the procedures above.

Carboxymethyl cellulose content (in %) = 100 - (% NaCl + % sodium glycolate)

6 Measurement of viscosity

6.1. Objective

6.1.1 This test method determines the viscosity of aqueous carboxymethylcellulose solutions within ranging from 10 to 10 000 mPa/s at 25 °C.

6.1.2 The concentration to be used for the test must be such that determination of the solution viscosity will be possible within the limits of the test.

6.1.3 The results of the carboxymethylcellulose viscosity measurement by the present test method are not necessarily identical to the results obtained with other types of instruments used for the measurement of viscosity.

6.1.4 The determinations are calculated on a dry weight, which requires knowledge of the water content of carboxymethylcellulose (see §1).

6.1.5 The recommended Brookfield spindles and the speeds are shown in table 1, but they can be adapted for greater convenience.

TABLE 1: Spindles and speeds required by the viscometer

Domaine de viscosité, (en mPa/s)	mobile n°	vitesse (en tr/min)	Echelle	Facteur
10 to 100	1	60	100	1
100 to 200	1	30	100	2
200 to 1000	2	30	100	10
1000 to 4000	3	30	100	40

6.2. Interest and use This test method is used to estimate the molecular weight of carboxymethylcellulose

6.3. Equipment

6.3.1 Brookfield viscometer.

6.3.2 Glass container, approximately 64 mm (2 ½ inches) in diameter and 152 mm (6 inches) tall, straight edged, 40 g capacity (12 oz).

6.3.3 Precision balance

6.3.4 Mechanical stirrers with a stainless steel blade fastened to a variable speed motor capable of functioning at 900 ± 100 r/min under different load conditions.

6.3.5 Water bath, at $25 \text{ °C} \pm 0.5 \text{ °C}$.

6.3.6 Precision thermometer capable of reading temperatures ranging from 20 to $30 \text{ °C} \pm 0.1 \text{ °C}$.

6.4. Test method

6.4.1 Determine the water content following § 1.

6.4.2 Calculate the dry weight of the sample in grams, *M*, required to prepare 240 g of the test solution as follows:

$$M = 100 A / (100 - B)$$

where:

A = desired dry mass of the sample in g, and

B = the water content of the sample in %.

6.4.3 Calculate the quantity of distilled water as follows:

$$V = 240 - S$$

where:

V = volume of distilled water in mL and

S = mass of the sample in g.

6.4.4 Add the quantity of water calculated in the jar. Position of the stirrer must allow a minimal clearance between the stirrer and the bottom of the container.

6.4.5 Begin stirring and to slowly add the carboxymethylcellulose. Adjust stirring speed to approximately 900 ± 100 r/min and mix for 2 hrs. Do not allow the stirring speed exceed 1,200 r/min as higher speeds tend to affect the viscosity of certain carboxymethylcellulose solutions.

NOTE: If the sample is added too quickly, an agglomeration will occur, which could prevent the complete dissolution of the sample in the indicated time interval.

6.4.6 Remove the stirrer and transfer the container containing the sample to the water bath until a constant temperature is reached (approximately one hour). Check the temperature of the sample with a thermometer at the end of one hour and make sure that the test temperature has been reached.

6.4.7 Remove the container containing the sample from the water bath and stir vigorously for 10 sec. Measure viscosity with the Brookfield viscometer, choosing the spindle and speed following table 1. Let the spindle turn for three minutes before carrying out the reading.

6.5. Calculation

28.1 Calculate viscosity, *V*, in millipascals per second (mP/s) as follows:

$$V = \text{reading} \times \text{factor}$$

6.6. Expression of results Express the result of Brookfield viscosity at 25 °C by indicating the concentration of the solution, the spindle, and the spindle speed used.

CELLULOSE
(C₁₂ H₂₀ O₁₀)_n
INS N°: 460
OENO 8/2002

1. OBJECT, ORIGIN AND FIELD OF APPLICATION

Cellulose is obtained from mechanical processing and purification from an alpha-cellulose, which comes directly from vegetable fibres. Its molecular weight is $1.5 \cdot 10^5$ Dalton. Cellulose fibre is used for its absorbency traits, mainly for the filtration of wine.

2. LABELLING

The concentration of the product and whether it was mixed, must be indicated on the label in addition to the change.

3. CHARACTERISTICS

Cellulose is a white odourless, flavourless, fibre. It is insoluble in water.

4. TEST TRIALS

4.1 pH

Mix 5g of cellulose in 40 ml of water free of carbon dioxide, for 20 minutes. Centrifuge. The pH of the supernatant will be between 5.0 and 7.5.

4.2 Humidity and volatile matter

Put 5 g of cellulose in an incubator at 105°C for 3 hours. Mass loss must not exceed 8%.

All of the maximum limits set below refer to the dried product.

4.3 Starch

Add 90 ml of water (R) to 10 g of microcrystalline cellulose and boil for 5 minutes. Filter when hot. Cool and add 0.1 ml of 0.05 M iodine to the filtrate. A blue colour should not appear.

4.4 Ashes

Incinerate at $600 \pm 25^{\circ}\text{C}$ the residue obtained according to point 4.2, for 4 hours. The weight of the ashes should not exceed 2%.

4.5 Preparation of the test solution

After weighing, dissolve ashes in 2 ml of concentrated hydrochloric acid (R) and 10 ml of water (R). Heat in order to dissolve and fill the water up to 50 ml. (R).

4.6 Iron

Determine iron using an atomic absorption spectrophotometer (following the method described in Chapter II on the test solution (4.5).

Iron content must be less than 100 mg/kg.

4.7 Lead

Measure out lead following the method described in Chapter II on the test solution (4.5). Lead content must be less than 5 mg/kg.

4.8 Mercury

Measure out mercury following the method described in Chapter II on the test solution (4.5).

Mercury content must be less than 1 mg/kg.

4.9 Cadmium

Measure out cadmium as described in Chapter II on the test solution (4.5).

Cadmium content must be less than 1 mg/kg.

4.10 Arsenic

Measure out arsenic following the method described in Chapter II on the test solution (4.5).

Arsenic content must be less than 2 mg/kg.

4.11 Calcium

Determine calcium using an atomic absorption spectrophotometer (see method described in Chapter II on the test solution (4.5). Calcium content must be less than 500 mg/kg.

4.12 Water soluble substances

Evaporate the aliquot part of the supernatant obtained when measuring the pH level at point 4.1, in an incubator at 105°C for 3 hours. The soluble substance content should not exceed 0.25%.

5. STORING CONDITIONS

Cellulose should be kept in a well-ventilated place in sealed packages away from volatile substances susceptible of being adsorbed.

POWDERED CELLULOSE

(C₁₂H₂₀O₁₀)_n
INS No.: 460 (ii)
CAS No.: 9004-34-6
(OIV-OENO 681-2022)

1. Object, origin and scope of application

Powdered cellulose is cellulose of food-grade quality. Cellulose is a linear glucose homopolymer composed of glucopyranose units linked by β -1,4-glycosidic bonds; its degree of polymerisation (DP) is dependent on the origin of the cellulosic material.

Powdered cellulose is a non-modified, purified cellulose, obtained by the mechanical disintegration of alpha-cellulose procured in pulp form from fibrous plant material.

Powdered cellulose plays a "support" role in clarified fermentation media; it allows for improved "degassing" of carbon dioxide at the start of alcoholic fermentation and thus shortens the latency phase. It increases the fermentability of must.

2. Labelling

The following should be mentioned on the label:

- the identification of the cellulose and its use in food,
- the concentration of the product, including in the case of a mixture,
- safety and storage conditions
- the batch no.,
- the expiry date.

3. Characteristics

Powdered cellulose comes in the form of flakes or very fine fibres, and is whitish in colour, odourless and flavourless.

4. Test limits and methods**4.1 Identification**

Place approx. 10 mg powdered cellulose on a watch glass and disperse into 2 mL iodinated zinc chloride solution (R). The solution will turn a blue-purple colour.

4.2 Solubility

Powdered cellulose is insoluble in water, ethanol, ether and diluted acids, and slightly soluble in sodium hydroxide solution.

4.3 Purity

The powdered cellulose content should not be less than 92%.

4.4 Size of fine particles

The size of fine particles should not be less than 5 µm; the number of particles smaller than 5µm should not exceed 10%.

4.5 pH

Mix approx. 10 g dry cellulose in 90 mL water free of carbon dioxide for 60 min. Centrifuge. The pH of the supernatant liquid should be between 5.0 and 7.5.

4.6 Water-soluble substances

Mix around 6 g of sample, dried beforehand, with 90 mL water that has recently been boiled then cooled. Leave to rest for 10 min. Filter using a membrane with porosity of 3 µm, throw away the first 10 mL of filtrate and pass the filtrate through the same filter a second time if necessary to obtain a clear filtrate. Evaporate a 15-mL portion of filtrate to dryness in a tared evaporating dish over a water bath, and dry to 105 °C for 1 h. Weigh the dish containing the dry residue. Less than 15 mg of residue should be obtained.

4.7 Detection of starch

Add 90 mL demineralised water (R) to 10 g powdered cellulose and boil for 5 min. Filter while hot with a 25-µm membrane filter. Cool and add 0.1 mL 0.05 M iodine solution to the filtrate. No blue colouration should

appear. With very fine grains, a light blue colour may be observed after the addition of the iodine solution but will disappear after 30 minutes.

4.8 Loss on drying

Place 1 g powdered cellulose in a tared dish in an oven at 100-105 °C for 3 hours. The loss on drying should not exceed 7.0%.

4.9 Ashes

Incinerate the residue obtained in point 4.8 at 800 ± 25 °C for 4 hours.^[SEP]The weight of the ashes should not be greater than 0.3%.

All of the limits set below relate to dry products.

5. Preparation of the test solution

After weighing, dissolve the ashes in 2 mL concentrated hydrochloric acid (R) and 10 mL water (R). Heat to activate dissolution and make up to 50 mL with water.

5.1 Iron

Determine the iron content of the solution prepared for testing purposes (5) by atomic absorption spectrophotometry according to the method described in Chapter II.^[SEP]The iron content should be less than or equal to 10 mg/kg.

5.2 Lead

Determine the lead content of the solution prepared for testing purposes (5) according to the method described in Chapter II.^[SEP]The lead content should be less than 2 mg/kg.

5.3 Mercury

Determine the mercury content of the solution prepared for testing purposes (5) according to the method described in Chapter II.^[SEP]The mercury content should be less than 1 mg/kg.

5.4 Cadmium

Determine the cadmium content of the solution prepared for testing purposes (5) according to the method described in Chapter II.^[SEP]The cadmium content should be less than 1 mg/kg.

5.5 Arsenic

Determine the arsenic content of the solution prepared for testing purposes (5) according to the method described in Chapter II.^[SEP]The arsenic content should be less than 1 mg/kg.

6. Storage

Powdered cellulose should be stored in a well-ventilated place in airtight packaging, away from any volatile substances that it could adsorb.

CHITIN-GLUCAN
 $[C_6H_{10}O_5]_m - [C_8H_{13}NO_5]_n$
CAS number Chitin: [1398-61-4]
CAS number β -glucan: [9041-22-9]
 OIV/OENO 367/2009

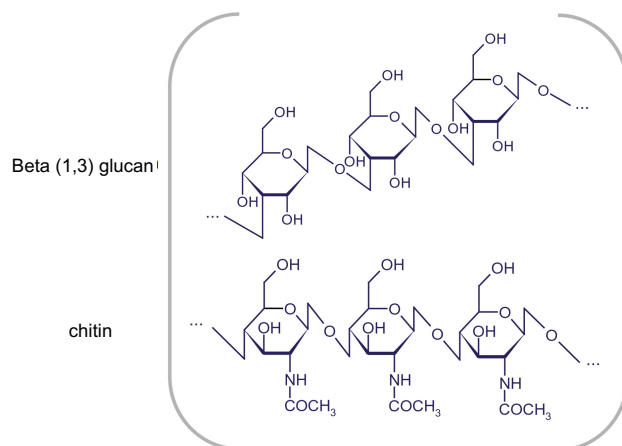

1 PURPOSE, ORIGIN AND SCOPE

Chitin-glucan is of fungus origin and is a natural polymer, the main component of the cellular walls of *Aspergillus niger*. It is initially extracted and purified from the mycelium of *Aspergillus niger*. This fungal resource is a by-product of the citric acid produced for the food and pharmaceutical markets.

Chitin-glucan is composed of polysaccharides chitin (repeat units N-acetyl-D-glucosamine) and 1,3- β -glucan (repeat unit D-glucose). The two polymers are covalently connected and form a three-dimensional network. The chitin/glucan ratio ranges from 25:75 to 60:40 (m/m).

It is used as a fining agent of musts during racking in order to reduce the colloid content and cloudiness.

It is also used for stabilising wines prior to bottling after alcoholic fermentation. This polymer has a stabilising capacity with respect to ferric breakages. It also helps eliminate undesirable compounds such as heavy metals (lead, cadmium), mycotoxins, etc.

2 SYNONYMS

Poly(N-acetyl-D-glucosamine)-poly(D-glucose) and 1,3-β-glucan

3 LABELLING

The following information must be stated on the packaging label: fungal origin, product for oenological use, use and conservation conditions and use-by date.

4 CHARACTERS**4.1 Aspect**

Chitin-glucan comes in the form of a white, odourless and flavourless powder. Chitin-glucan is almost completely insoluble in aqueous or organic medium.

4.2 Purity and soluble residues

The purity of the product must be equal to or higher than 95 %.
Dissolve 5 g of chitin-glucan in 100 ml of bidistilled water and agitate for 2 minutes. Filter after cooling on a fine mesh filter or membrane.
Evaporate the filtrate and dry at 100-105 °C. The content of solubles should not be higher than 5 %.

5 TESTS**5.1 Identification and chitin-glucan ratio****5.1.1 Determination of the chitin-glucan ratio**

The chitin/glucan ratio is determined using the ¹³C NMR spectrum in solid phase, by comparison with the spectrum of a pure chitin reference sample.

This method is detailed in appendix I.

5.2 Loss during desiccation

In a glass cup, previously dried for 1 hour in an oven at 100-105 °C and cooled in a desiccator, place 10 g of the analyte. Allow to desiccate in the drying oven at 100-105 °C to constant mass. Weigh the dry residue amount after cooling in the desiccator.

The weight loss must be lower than 10 %.

Note: all the limits stated below are reported in dry weight except for the microbiological analyses

5.3 Ashes

Incinerate without exceeding 600°C the residue left from the determination of the loss during desiccation as described in 5.2. Allow to calcine for 6 hours. Allow the crucible to cool in a desiccator and weigh.

The total ash content should not be higher than 3 %.

5.4 Preparation of the test solution

Before determining the metals, the sample is dissolved by acid digestion (HNO₃, H₂O₂ and HCl). Mineralisation is performed in a closed microwave system. The sample undergoes neither crushing nor drying before mineralisation.

The reagents used for the mineralisation of chitin-glucan are as follows: HNO₃ (65 %) (Suprapur), HCl (37 %) (Suprapur), H₂O₂ (35 %). The 0.5 to 2 g sample of chitin-glucan is placed in a flask to which are added 25 ml of HNO₃, 2 ml of HCl and 3 ml of H₂O₂. This is submitted to microwave digestion (Power of 60 % for 1 min, 30 % for 10 min, 15 % for 3 min, and 40 % for 15 min). The solution is diluted in a volumetric flask with bidistilled water to a final volume of 25.0 ml.

The metal contents can then be determined.

5.5 Lead

Lead is determined by atomic absorption spectrophotometry, using the method described in appendix II.

The lead content must be lower than 1 mg/kg.

It is also possible to achieve lead determination by atomic absorption, using the method described in chapter II of the International Oenological Codex.

5.6 Mercury

Mercury is determined by atomic absorption spectrophotometry, using the method described in appendix II.

The mercury content must be lower than 0.1 mg/kg.

It is also possible to achieve mercury determination by atomic absorption, using the method described in chapter II of the International Oenological Codex.

5.7 Arsenic

Arsenic is determined by atomic absorption spectrophotometry, using the method described in appendix II.

The arsenic content must be lower than 1 mg/kg.

It is also possible to achieve arsenic determination by atomic absorption, using the method described in chapter II of the International Oenological Codex.

5.8 Cadmium

Cadmium is determined by atomic absorption spectrophotometry, using the method described in appendix II.

The cadmium content must be lower than 1 mg/kg.

It is also possible to achieve cadmium determination by atomic absorption, using the method described in chapter II of the International Oenological Codex.

5.9 Chromium

Chromium is determined by atomic absorption spectrophotometry, using the method described in appendix II.

The chromium content must be lower than 10 mg/kg.

It is also possible to achieve chromium determination by atomic absorption, using the method described in chapter II of the International Oenological Codex.

5.10 Zinc

Zinc is determined by atomic absorption spectrophotometry, using the method described in appendix II.

The zinc content must be lower than 50 mg/kg.

It is also possible to achieve zinc determination by atomic absorption, using the method described in chapter II of the International Oenological Codex.

5.11 Iron

Iron is determined by atomic absorption spectrophotometry, using the method described in appendix II.

The iron content must be lower than 100 mg/kg.

It is also possible to achieve iron determination by atomic absorption, using the method described in chapter II of the International Oenological Codex.

5.12 Copper

Copper is determined by atomic absorption spectrophotometry, using the method described in appendix II.

The copper content must be lower than 30 mg/kg.

It is also possible to achieve copper determination by atomic absorption, using the method described in chapter II of the International Oenological Codex.

5.13 MICROBIOLOGICAL CONTROL**5.13.1 Total bacteria count**

The total bacteria count is performed according to the horizontal method by means of the colony count technique at 30 °C on the PCA medium described in appendix III.

Less than 1000 CFU/g of preparation.

It is also possible to carry out the enumeration as described in chapter II of the International Oenological Codex.

5.13.2 Enterobacteria

The enumeration of *Enterobacteria* is carried out according to the horizontal method by means of the colony count technique at 30 °C described in appendix IV.

Less than 10 CFU/g of preparation.

5.13.3 Salmonella

Carry out the enumeration as described in chapter II of the International Oenological Codex.

Absence checked on a 25 g sample.

5.13.4 Coliform bacteria

Carry out the enumeration as described in chapter II of the International Oenological Codex.

Less than 100 CFU/g of preparation.

5.13.5 Yeasts

The enumeration of yeasts is carried out according to the horizontal method by means of the colony count technique at 25 °C on the YGC medium described in appendix V.

Less than 100 CFU/g of preparation.

It is also possible to carry out the enumeration as described in chapter II of the International Oenological Codex.

5.13.6 Moulds

The enumeration of moulds is carried out according to the horizontal method by means of the colony count technique at 25 °C on the YGC medium described in appendix VI.

Less than 100 CFU/g of preparation.

It is also possible to carry out the enumeration as described in chapter II of the International Oenological Codex.

6 OCHRATOXIN A TESTING

Prepare an aqueous solution (distilled water) of chitin-glucan at 1 % and agitate for 1 hour, then carry out determination using the method described in the Compendium of International Methods of Analysis of Wine and Musts.

Less than 5 µg/kg.

7 STORAGE

Keep container closed and store in a cool and dry place.

**Appendix I
Determination of the chitin/glucan ratio****1. PRINCIPLE**

This method consists in determining the chitin/glucan ratio using the ^{13}C RMN spectrum in solid phase.

2. REAGENTS AND MATERIALS

- 2.1. Chitin glucan sample
- 2.2. Osmosis purified water
- 2.3. Hydrochloric acid 1 M
- 2.4. Pure ethanol
- 2.5. Pure chloroform
- 2.6. Pure methanol
- 2.7. Acetone
- 2.8. Standard laboratory material, pipettes, cylindrical glass vases, porosity filters 30 μm ...
- 2.9. Rotary shaker
- 2.10. Laboratory centrifuge
- 2.11. Conductimeter
- 2.12. Nuclear Magnetic resonance apparatus

3. SAMPLE PREPARATION

Before the determination, samples are prepared according to a precise protocol as described below:

- 3.1 Washing with HCl 1 M (2.3)

This step consists in mixing 2 g of chitin-glucan (2.1) and 40 ml of HCl 1 M in a tube flask.

This mixture is agitated for 30 min at 320 rpm then centrifuged at 4000 rpm for 10 min. The supernatant is eliminated.

This step is repeated once.

- 3.2 Washing with osmosis purified water

This step consists in mixing the sediment from the previous step with 40 ml of osmosis purified water (2.2).

This mixture is centrifuged for 10 min at 4000 rpm. The supernatant is eliminated.

This step is repeated until the supernatant conductivity is lower than 100 $\mu\text{S}/\text{cm}$.

- 3.3 Washing with ethanol

This step consists in mixing the sediment from the previous step with 40 ml of ethanol (2.4).

This mixture is centrifuged for 10 min at 4000 rpm. The supernatant is eliminated.

This step is repeated once.

- 3.4 Washing with chloroform/methanol

This step consists in mixing the sediment from the previous step with 40 ml of a of 50/50, v/v of chloroform (2.5) and methanol (2.6) mixture.

This mixture is agitated for 30 min at 320 rpm then centrifuged at 4000 rpm for 10 min. The supernatant is eliminated.

This step is repeated once.

- 3.5 Washing with acetone and drying

This step consists in mixing the sediment from the previous step with 40 ml of acetone (2.7).

This mixture is agitated for 30 min at 320 rpm then centrifuged at 4000 rpm for 10 min.

After centrifugation, pour the supernatant on a 30 μm filter, rinse the tube flask with acetone (2.7) and pour everything on the filter.

Place the material located on the filter in a crystallising dish and allow to dry.

After drying, the product is ready to be analysed by NMR.

4. PROCEDURE

The prepared samples are then analysed on the Brücker Avance DSX 400WB nuclear magnetic resonance instrument (or the equivalent).

The analysis conditions are as follows:

- Magnetic field: 9.04 Tesla
- Larmor frequency: 83 kHz
- Time interval between 2 magnetic pulses: 5s

- Time period during which the magnetic pulse is applied: 5,5ms
- Number of magnetic pulse sequences: 3000

5. EXPRESSION OF THE RESULTS

5.1 The beta-glucan content is determined from the area of the four resonance bands.

5.2 The results are expressed in mol %.

Appendix II
METAL DETERMINATION BY ATOMIC EMISSION SPECTROSCOPY

1. PRINCIPLE

This method consists in measuring atomic emission by an optical spectroscopy technique.

2. SAMPLE PREPARATION

Before the determination of metals, the sample is dissolved by acid digestion (HNO₃, H₂O₂ and HCl). Mineralisation takes place in closed microwave system. The sample undergoes neither crushing nor drying before mineralisation.

The reagents used for the mineralisation of chitosan are as follows: HNO₃ (65 %) (Suprapur), HCl (37 %) (Suprapur), H₂O₂ (35 %). The 0.5 to 2 g sample of chitin-glucan is placed in a flask to which are added 25 ml of HNO₃, 2 ml of HCl and 3 ml of H₂O₂. The whole is then submitted to microwave digestion (Power of 60 % for 1 min, 30 % for 10 min, 15 % for 3 min, and 40 % for 15 min). The solution is then diluted in a volumetric flask with bidistilled water to a final volume of 25.0 ml.

The metal contents can then be determined.

3. PROCEDURE

The dissolved samples are nebulised and the resulting aerosol is transported in a plasma torch induced by a high frequency electric field. The emission spectra are dispersed by a grating spectrometer and the line intensity is evaluated by a detector (photomultiplier). The detector signals are processed and controlled by a computer system. A background noise correction is applied to compensate for the background noise variations.

4. EXPRESSION OF THE RESULTS

The metal concentrations in the oenological products are expressed in mg/kg

Appendix III**Total bacteria count by counting the colonies obtained at 30 °C****PCA medium**Composition:

Peptone	5.0 g
Yeast extract	2.5 g
Glucose	1.0 g
Agar-agar	15 g
Adjusted to	pH 7.0
Water	complete to 1000 ml

The medium is sterilised before use in an autoclave at 120 °C for 20 min.

The Petri dishes are inoculated by pour plate method and spiral plating method.

After inoculation, they are incubated at 30 °C in aerobiosis for 48 to 72 hours.

Count the CFU number.

Appendix IV

Enumeration of *Enterobacteria* is carried out according to the horizontal method by means of the colony count technique at 30 °C

VRBG mediumComposition:

Peptone	7 g
Yeast extract	3 g
Glucose	10 g
Sodium Chloride	5 g
Crystal Violet	0.002 g
Neutral Red	0.03 g
Agar-agar	13 g
Bile salts	1.5 g
Adjusted to	pH 7.4
Water	complete to 1000 ml

The medium is sterilised before use in an autoclave at 120 °C for 20 min.

The Petri dishes are inoculated by pour plate method and spiral plating method.

After inoculation, they are incubated at 30 °C in aerobiosis for 18 to 24 hours.

Count the CFU number.

**Appendix V
Enumeration of yeasts by counting****YGC medium**Composition:

Yeast extract	5.0 g
D-glucose	20 g
Agar-agar	14.9 g
Choramphenicol	0.1 g
Adjusted to	pH 6.6
Water	complete to 1000 ml

The medium is sterilised before use in an autoclave at 120 °C for 20 min.

The Petri dishes are inoculated by pour plate method and spiral plating method.

After inoculation, they are incubated at 25 °C in aerobiosis for 3 to 5 days without being turned over.

Count the number of yeasts.

**Appendix VI
Enumeration of the moulds by counting****YGC medium**Composition:

Yeast extract	5.0 g
D-glucose	20 g
Agar-agar	14.9 g
Choramphenicol	0.1 g
Adjusted to	pH 6.6
Water	complete to 1000 ml

The medium is sterilised before use in an autoclave at 120 °C for 20 min.

The Petri dishes are inoculated by pour plate method and spiral plating method.

After inoculation, they are incubated at 25 °C in aerobiosis for 3 to 5 days without being turned over.

Count the number of moulds.

CHITOSAN
[C₆H₁₁NO₄]_n
CAS number Chitosan: [9012-76-4]
OIV/OENO 368/2009

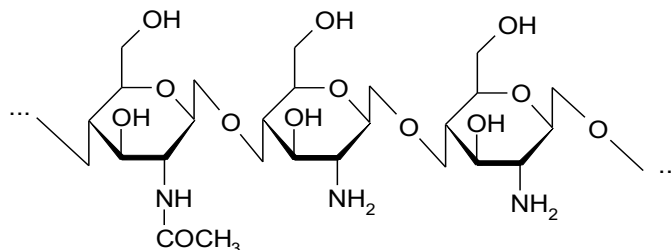

Chitosan

1 PURPOSE, ORIGIN AND APPLICABILITY

Chitosan, a natural polysaccharide prepared of fungal origin, is initially extracted and purified from reliable and abundant food or biotechnological fungal sources such as *Agaricus bisporus* or *Aspergillus niger*.

Chitosan is obtained by hydrolysis of a chitin-rich extract. Chitin is a polysaccharide composed of several N-acetyl-D-glucosamine units interconnected by β→ (1.4) type linkages.

Chitosan is composed of glucosamine sugar units (deacetylated units) and N-acetyl-D-glucosamine units (acetylated units) interconnected by β→ (1.4) type linkages.

It is used as a fining agent in the treatment of musts for flotation clarification to reduce cloudiness and the content of unstable colloids.

It is also used for stabilising wines. This polymer actually helps eliminate undesirable micro-organisms such as *Brettanomyces*.

2 SYNONYMS

Poly(N-acetyl-D-glucosamine)-poly(D-glucose).

3 LABELLING

The following information must be stated on the packaging label: exclusively fungal origin, product for oenological use, use and conservation conditions and use-by date.

4 CHARACTERS

4.1 Aspect and solubility

Chitosan comes in the form of a white, odourless and flavourless powder. Chitin-glucan is almost completely insoluble in aqueous or organic medium.

4.2 Purity and soluble residues

The purity of the product must be equal to or higher than 95 %. Dissolve 5 g of chitin-glucan in 100 ml of bidistilled water and agitate for 2 minutes. Filter after cooling on a fine mesh filter or membrane. Evaporate the filtrate and dry at 100-105 °C. The content of solubles should not be higher than 5 %.

5 TESTS

5.1 Determination of the acetylation degree and chitosan origin

5.1.1 Determination of the acetylation degree

The acetylation degree is determined by potentiometric titration, using the method described in Appendix I.

5.1.2 Determination of the source

Chitosan, as a natural polymer, is extracted and purified from fungal sources; it is obtained by hydrolysis of a chitin-rich extract. This chitosan is considered identical to chitosan from shellfish in terms of structures and properties.

An identification of the origin of chitosan is made based on 3 characteristics: content of residual glucans (refer to method in annex II), viscosity of chitosan in solution 1 % and settled density (following settlement).

Only fungal origin chitosan has both contents of residual glucan > at 2 %, a settled density \geq at 0,7 g/cm³ and viscosity in solution 1 % in acetic acid 1 % < at 15 cPs

5.2 Loss during desiccation

In a glass cup, previously dried for 1 hour in an oven at 100-105 °C and cooled in a desiccator, place 10 g of the analyte. Allow to desiccate in

the drying oven at 100-105 °C to constant mass. Weigh the dry residue amount after cooling in the desiccator.

The weight loss must be lower than 10 %.

Note: all the limits stated below are reported in dry weight except for the microbiological analyses

5.3 Ashes

Incinerate without exceeding 600 °C the residue left from the determination of the loss during desiccation as described in 5.2. Allow to calcine for 6 hours. Allow the crucible to cool in a desiccator and weigh.

The total ash content should not be higher than 3 %.

5.4 Preparation of the test solution

Before determining the metals, the sample is dissolved by acid digestion (HNO₃, H₂O₂ and HCl). Mineralisation is performed in a closed microwave system. The sample undergoes neither crushing nor drying before mineralisation.

The reagents used for the mineralisation of chitosan are as follows: HNO₃ (65 %) (Suprapur), HCl (37 %) (Suprapur), H₂O₂ (35 %). The 0.5 to 2 g sample of chitosan is placed in a flask to which are added 25 ml of HNO₃, 2 ml of HCl and 3 ml of H₂O₂. This is submitted to microwave digestion with a maximum power of 1200 watts; Power of 60 % for 1 min, 30 % for 10 min, 15 % for 3 min, and 40 % for 15 min). The solution is diluted in a volumetric flask with bidistilled water to a final volume of 25.0 ml.

The metal contents can then be determined.

5.5 Lead

Lead is determined by atomic absorption spectrophotometry, using the method described in appendix II.

The lead content must be lower than 1 mg/kg.

It is also possible to achieve lead determination by atomic absorption, using the method described in chapter II of the International Oenological Codex.

5.6 Mercury

Mercury is determined by atomic absorption spectrophotometry, using the method described in appendix II.

The mercury content must be lower than 0.1 mg/kg.

It is also possible to achieve mercury determination by atomic absorption, using the method described in chapter II of the International Oenological Codex.

5.7 Arsenic

Arsenic is determined by atomic absorption spectrophotometry, using the method described in appendix II.

The arsenic content must be lower than 1 mg/kg.

It is also possible to achieve arsenic determination by atomic absorption, using the method described in chapter II of the International Oenological Codex.

5.8 Cadmium

Cadmium is determined by atomic absorption spectrophotometry, using the method described in appendix II.

The cadmium content must be lower than 1 mg/kg.

It is also possible to achieve cadmium determination by atomic absorption, using the method described in chapter II of the International Oenological Codex.

5.9 Chromium

Chromium is determined by atomic absorption spectrophotometry, using the method described in appendix II.

The chromium content must be lower than 10 mg/kg.

It is also possible to achieve chromium determination by atomic absorption, using the method described in chapter II of the International Oenological Codex.

5.10 Zinc

Zinc is determined by atomic absorption spectrophotometry, using the method described in appendix II.

The zinc content must be lower than 50 mg/kg.

It is also possible to achieve zinc determination by atomic absorption, using the method described in chapter II of the International Oenological Codex.

5.11 Iron

Iron is determined by atomic absorption spectrophotometry, using the method described in appendix II.

The iron content must be lower than 100 mg/kg.

It is also possible to achieve iron determination by atomic absorption, using the method described in chapter II of the International Oenological Codex.

5.12 Copper

Copper is determined by atomic absorption spectrophotometry, using the method described in appendix II.

The copper content must be lower than 30 mg/kg.

It is also possible to achieve copper determination by atomic absorption, using the method described in chapter II of the International Oenological Codex.

5.13 MICROBIOLOGICAL CONTROL

5.13.1 Total bacteria count

The total bacteria count is performed according to the horizontal method by means of the colony count technique at 30 °C on the PCA medium described in appendix III.

Less than 1000 CFU/g of preparation.

It is also possible to carry out the enumeration as described in chapter II of the International Oenological Codex.

5.13.2 Enterobacteria

The enumeration of *Enterobacteria* is carried out according to the horizontal method by means of the colony count technique at 30 °C described in appendix IV.

Less than 10 CFU/g of preparation.

5.13.3 Salmonella

Carry out the enumeration as described in chapter II of the International Oenological Codex.

Absence checked on a 25 g sample.

5.13.4 Coliform bacteria

Carry out the enumeration as described in chapter II of the International Oenological Codex.

Less than 100 CFU/g of preparation.

5.13.5 Yeasts

The enumeration of yeasts is carried out according to the horizontal method by means of the colony count technique at 25 °C on the YGC medium described in appendix VI.

Less than 100 CFU/g of preparation.

It is also possible to carry out the enumeration as described in chapter II of the International Oenological Codex.

5.13.6 Moulds

The enumeration of moulds is carried out according to the horizontal method by means of the colony count technique at 25 °C on the YGC medium described in appendix VII.

Less than 100 CFU/g of preparation.

It is also possible to carry out the enumeration as described in chapter II of the International Oenological Codex.

6 OCHRATOXIN A TESTING

Prepare an aqueous solution (distilled water) of chitosan at 1 % and agitate for 1 hour, then carry out determination using the method described in the Compendium of International Methods of Analysis of Wine and Musts.

Less than 5 µg/kg.

7 STORAGE

Keep container closed and store in a cool and dry place.

Appendix I**DETERMINATION OF THE ACETYLATION DEGREE****1. PRINCIPLE**

This method consists in determining the acetylation degree of chitosan by titration of the amino groups. The acetylation degree is the ratio of the number of N-acetyl-glucosamine units to the number of total monomers.

This method is based on the method described by Rinaudo et al., (1999).

The titration of a chitosan solution by means of NaOH at 0.1 M must be performed in order to identify two pH jumps from 0 to 14.

Chitosan is dissolved in 0.1M HCl, the amino groups (on the deacetylated glucosamine units (G)) are positively charged (HCl in excess)).

The chitosan solution (of known quantity) is titrated by NaOH of known concentration. In the first part of the reaction, the excess quantity of HCl is determined:

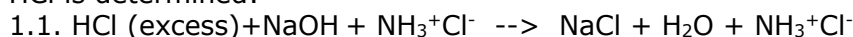

After the first pH jump, the quantity of charged amino groups is determined:



13. After the second pH jump, the excess quantity of NaOH is measured. The determination of the NaOH volume between the two jumps makes it possible to identify the quantity of charged amines.

2. REAGENTS ET MATERIALS

- 2.1. Commercial preparation of chitosan
- 2.2. Distilled or deionised water
- 2.3. Chlorhydric acid 0,3 M
- 2.4. Sodium Hydroxide 0,1M
- 2.5. Glass cylindrical flasks, pipettes, burettes...
- 2.6. Magnetic mixer and stir bar
- 2.7. pH-meter with temperature sensor.

3. SAMPLES PREPARATION

Before determination, the samples are prepared according to the protocol described hereafter:

100 mg of chitosan are placed into a cylindrical flask to which 3 ml of 0.3 M HCl and 40 ml of water are added. Agitate for 12 hours.

4. PROCEDURE

First introduce the pH electrode of the pH-meter as well as the temperature sensor into the cylindrical flask. Check that the pH value is lower than 3.

To bring to pH = 1, add a V1 volume (ml) of HCl 0.3 M and agitate.

Then to bring to pH = 7 with a V2 volume (ml) of 0.1 M NaOH

These operations can be carried out using an automatic titrator.

5. EXPRESSION OF RESULTS

The acetylation degree of chitosan is expressed in %. This formula is the ratio of the mass of acetylated glucosamine (aG) units in g actually present in the sample, to the mass in g that would be present if all the groups were acetylated, where:

$$Q = (V_{\text{NaOH}} \times 0.1) / (1000 \times M_{\text{cs}})$$

= specific concentration in amino groups

Mcs: dry weight of chitosan in g

$$V_{\text{NaOH}} = V2 - V1$$

= volume of 0.1 M NaOH between 2 pH jumps in ml

For a 1 g sample

With G = Glucosamine part; a = acetylated part

aG weight actually present (in g) =

$$1g - (\text{Number of moles of G groups/g}) \times G \text{ molecular weight} =$$

$$1g - Q \times 162$$

aG weight if all the deacetylated groups were acetylated (in g) =

$$1g + (\text{Number of moles of G groups/g}) \times \text{molecular weight a} =$$

$$1g + Q \times 42$$

The acetylation degree will be equal to DA, where:

$$DA = (1-162 \times Q) / (1+ 42 \times Q)$$

Bibliography

Rinaudo, M., G. Pavlov and J. Desbrieres. 1999. Influenced of acetic acid concentration on the solubilization of chitosan. *Polym.* 40, 7029-7032.

Appendix II**DETERMINATION OF THE RESIDUAL GLUCAN CONTENT****1. PRINCIPLE**

This method consists in determining the content of residual glucans in chitosan by means of spectrophotometry.

This method is based on a colorimetric reaction with a response depending on the degradation of the starch hydrolysates by hot concentrated sulphuric acid.

This degradation gives a brown yellow compound with a colour intensity proportional to the content of residual glucans.

2. REAGENTS ET MATERIALS

- 2.1 Glucan 97% (Société Mégazyme)
- 2.2 Commercial preparation of chitosan
- 2.3 Distilled or deionised water
- 2.4 Ethanol
- 2.5 Acetic acid 1%
- 2.6 Solution of phenol 5%
- 2.7 Glacial acetic acid 100%
- 2.8 Glass cylindrical flasks, pipettes, volumetric flasks,...
- 2.9 Magnetic mixer and stir bar
- 2.10 Chronometer

3. PREPARATION OF THE STANDARD RANGE

A stock solution of glucan (glucan with a purity of 97 % is provided by the company Megazyme) is prepared according to the precise protocol described hereafter:

500 mg of glucan are introduced into a volumetric flask of 100 ml into which 6 ml of ethanol and 80 ml of distilled water are added.

Agitate and boil out to allow glucan dissolution

Allow to cool, adjust to the filling mark with water

Agitate for 30 minutes.

Pour 1 ml of this solution into a 50 ml volumetric flask and adjust to the filling mark with 1 % acetic acid.

The solution is ready to use to produce the standard range according to the protocol hereafter.

Stock solution V (ml)	Water V (ml)	Glucan M (μg)
0	1	0
0.1	0.9	10
0.3	0.7	30
0.5	0.5	50
0.7	0.3	70

4. SAMPLES PREPARATION

Before determination, the samples are prepared according to the protocol described hereafter:

100 mg of chitosan are placed into a 50 ml volumetric flask to which 25 ml of 1 % acetic acid are added.

Agitate for 12 hours then adjust to the filling mark.

5. PROCEDURE

In a test tube, add 1 ml of the analyte solution, 1 ml of phenol at 5 % and 5 ml of concentrated sulphuric acid.

Agitate this mixture using a vortex for 10 s, then allow to cool for 1 hour.

The absorbance A is measured at 490 nm.

6. EXPRESSION OF THE RESULTS

Determine the glucan content in $\mu\text{g/g}$ from the calibration curve (0-70 μg). This content is expressed in $\mu\text{g/g}$ of chitosan.

Appendix III**METAL DETERMINATION BY ATOMIC EMISSION SPECTROSCOPY****1. PRINCIPLE**

This method consists in measuring atomic emission by an optical spectroscopy technique.

2. SAMPLE PREPARATION

Before the determination of metals, the sample is dissolved by acid digestion (HNO₃, H₂O₂ and HCl). Mineralisation takes place in closed microwave system. The sample undergoes neither crushing nor drying before mineralisation.

The reagents used for the mineralisation of chitosan are as follows: HNO₃ (65 %) (Suprapur), HCl (37 %) (Suprapur), H₂O₂ (35 %). The 0.5 to 2 g sample of chitosan is placed in a flask to which are added 25 ml of HNO₃, 2 ml of HCl and 3 ml of H₂O₂. The whole is then submitted to microwave digestion (Power of 60 % for 1 min, 30 % for 10 min, 15 % for 3 min, and 40 % for 15 min). The solution is then diluted in a volumetric flask with bidistilled water to a final volume of 25.0 ml.

The metal contents can then be determined.

3. PROCEDURE

The dissolved samples are nebulised and the resulting aerosol is transported in a plasma torch induced by a high frequency electric field. The emission spectra are dispersed by a grating spectrometer and the line intensity is evaluated by a detector (photomultiplier). The detector signals are processed and controlled by a computer system. A background noise correction is applied to compensate for the background noise variations.

4. EXPRESSION OF THE RESULTS

The metal concentrations in chitosan are expressed in mg/kg.

Appendix IV**Total bacteria count by counting the colonies obtained at 30 °C****PCA medium**Composition:

Peptone	5.0 g
Yeast extract	2.5 g
Glucose	1.0 g
Agar-agar	15 g
Adjusted to	pH 7.0
Water	complete to 1000 ml

The medium is sterilised before use in an autoclave at 120 °C for 20 min.

The Petri dishes are inoculated by pour plate method and spiral plating method.

After inoculation, they are incubated at 30 °C in aerobiosis for 48 to 72 hours.

Count the CFU number.

Appendix V

Enumeration of *Enterobacteria* is carried out according to the horizontal method by means of the colony count technique at 30 °C

VRBG mediumComposition:

Peptone	7 g
Yeast extract	3 g
Glucose	10 g
Sodium Chloride	5 g
Crystal Violet	0.002 g
Neutral Red	0.03 g
Agar-agar	13 g
Bile salts	1.5 g
Adjusted to	pH 7.4
Water	complete to 1000 ml

The medium is sterilised before use in an autoclave at 120 °C for 20 min.

The Petri dishes are inoculated by pour plate method and spiral plating method.

After inoculation, they are incubated at 30 °C in aerobiosis for 18 to 24 hours.

Count the CFU number.

Appendix VI**Enumeration of yeasts by counting****YGC medium**Composition:

Yeast extract	5.0 g
D-glucose	20 g
Agar-agar	14.9 g
Choramphenicol	0.1 g
Adjusted to	pH 6.6
Water	complete to 1000 ml

The medium is sterilised before use in an autoclave at 120 °C for 20 min.

The Petri dishes are inoculated by pour plate method and spiral plating method.

After inoculation, they are incubated at 25 °C in aerobiosis for 3 to 5 days without being turned over.

Count the number of yeasts.

Appendix VII**Enumeration of the moulds by counting****YGC medium**Composition:

Yeast extract	5.0 g
D-glucose	20 g
Agar-agar	14.9 g
Choramphenicol	0.1 g
Adjusted to	pH 6.6
Water	complete to 1000 ml

The medium is sterilised before use in an autoclave at 120 °C for 20 min.

The Petri dishes are inoculated by pour plate method and spiral plating method.

After inoculation, they are incubated at 25 °C in aerobiosis for 3 to 5 days without being turned over.

Count the number of moulds.

CITRIC ACID, MONOHYDRATE
Monohydrated 3-Carboxy-3-hydroxypentanedioic acid
Acidum citricum
C₆H₈O₇·H₂O = 210.1
SIN NO. 330
OENO 23/2000

1. OBJECTIVE, ORIGIN AND SCOPE OF APPLICATION

Citric acid can be used to chemically acidify wines or as a stabilizing agent to limit, in particular, the risks of iron breakdown, or again, for prewashing filter plates. Its maximum proportions in wine may be subject to statutory limits.

2. LABELING

The label should indicate product concentration, even when included in mixtures, as well as its safety and storage conditions.

3. PROPERTIES

Citric acid is found in the form of colorless, translucent crystals which are rather friable and slightly efflorescent, or in crystalline powder form.

$$D \begin{array}{l} 20^{\circ}\text{C} \\ 4^{\circ}\text{C} \end{array} = 1.542$$

4. SOLUBILITY

Water at 20 °C	very soluble
Alcohol, 95% by vol.	very soluble
Glycerol	very soluble
Ethyl ether	31.5 g/l

Aqueous citric acid is inert in polarized light.

5. IDENTIFYING CHARACTERISTICS

5.1. Verify total solubility in water. A 1 pp 100 solution (m/v) shows an acid reaction to methyl orange (R).

5.2. Place 2 ml of an aqueous 1 g/l citric acid solution and 0.5 ml of mercury (II) sulfate solution (R) in a test tube. Bring to a boil and add several drops of 2 pp 100 potassium permanganate solution (R). A white precipitate should form.

5.3. Add 1 drop of bromine water (R), 3 drops of concentrated sulfuric acid (R) and 1 drop of saturated potassium permanganate solution to 0.1 ml of 10 pp 100 (m/v) aqueous citric acid solution. Bring to a boil.

Add 2 ml of concentrated sulfuric acid (R). Heat again until completely dissolved. Let cool, then add 0.1 ml of beta-naphthol (R). A green coloring should appear. A pink coloring is obtained under the same conditions if sulforesorcin reagent (R) is used under the same conditions.

5.4. Place 5 ml of chloroform or dichloromethane in a test tube. Add 100-200 mg of citric acid. Shake. The crystals or crystalline powder should collect together at the surface of the liquid. Under these same conditions, tartaric acid collects at the very bottom of the tube.

6. TESTS

6.1. Foreign Substances

Citric acid should be soluble without residue in its weight of water and in twice its weight of 95% alcohol (by volume).

6.2. Sulfur Ash

After calcination at $600\text{ }^{\circ}\text{C} \pm 25\text{ }^{\circ}\text{C}$, the concentration of sulfur ash should not be greater than 0.5 g/kg.

6.3. Tartaric Acid Determination

Add 2 drops of sulforesorcinic reagent (R) and 2 drops of 10 pp 100 (m/v) citric acid solution to 2 ml of concentrated sulfuric acid (R). Heat to $150\text{ }^{\circ}\text{C}$. The solution should not develop a violet coloring.

6.4. Preparing the Solution for Tests

Prepare a 10 parts per 100 (m/v) solution.

6.5. Chlorides

Add 14.5 ml of water, 5 ml of nitric acid diluted to 10 pp 100 (R) and 0.5 ml of 5 pp 100 silver nitrate solution (R) to 0.5 ml of the solution prepared for tests under paragraph 6.4. After sitting for 15 minutes in the dark, there should be no clouding. If clouding does occur, it should be less intense than that observed in a control prepared as indicated in the Annex. (Chloride content expressed in terms of hydrochloric acid should be less than 1 g/kg).

6.6. Sulfates

Add 18 ml of water, 1 ml of diluted hydrochloric acid (R) and 2 ml of 10 pp 100 barium chloride solution diluted to 10 pp 100 (R) to 1 ml of the solution prepared for tests under paragraph 6.4. After 15 minutes, there should be no clouding. If clouding does occur, it should be less intense than that observed in a control prepared by replacing the test solution with 1 ml of 0.1 g/l sulfuric acid solution. (Sulfate content expressed in terms of sulfuric acid should be less than 1 g/kg).

6.7. Oxalic Acid and Barium

Neutralize 5 ml of the solution prepared for tests under paragraph 6.4 by adding concentrated ammonium hydroxide (R). Add 2 drops of acetic acid (R) and 5 ml of saturated calcium sulfate solution (R). There should be no clouding. (Oxalate content expressed in terms of oxalic acid should be less than 0.1g/kg).

6.8. Iron

Add 1 ml of concentrated hydrochloric acid (R) and 2 ml of 5 pp 100 potassium thiocyanate solution (R) to 10 ml of the solution prepared for tests under paragraph 6.4. The resulting red coloration should be less intense than that observed in a control using 1 ml of iron (III) salt solution in a concentration of 0.010 g of iron per liter, 9 ml of water and the same quantities of the same reagents. (Iron content should be less than 10 mg/kg).

Iron may also be analytically quantified by atomic absorption spectrometry in accordance with the technique detailed in the Compendium.

6.9. Cadmium

Using the method described in the Annex, quantify cadmium analytically in the test solution prepared according to Par. 6.4. (Cadmium content should be less than 1 mg/kg).

6.10. Lead

Using the method described in the Compendium, determine lead content analytically in the test solution prepared according to Par. 6.4. (Lead content should be less than 1 mg/kg).

6.11. Mercury

Using the method described in the Annex, determine the mercury content analytically in the test solution prepared according to Par. 6.4. (Mercury content should be less than 1 mg/kg).

6.12. Arsenic

Using the method described in the Annex, determine the arsenic content analytically in the test solution prepared according to Par. 6.4. (Arsenic content should be less than 1 mg/kg).

7. STORAGE

Citric acid should be stored in a dry place in air-tight bags.

COLLOIDAL SILICON DIOXIDE SOLUTION*Silica colloidalis solutio***SILICON GEL IN AQUEOUS DISPERSION**OENO 4/87 ;
OENO 44/2000 ;
OIV-OENO 617-2019**1. OBJECTIVE, ORIGIN AND SCOPE OF APPLICATION**

Colloidal silicon dioxide solutions are aqueous dispersions of silicon dioxide particles which are hydroxylated on the surface and are, therefore, negatively charged.

Silica gel is the dried powder form of silicon dioxide

These preparations are used to clarify wines and are associated with protein-based clarifying agents.

2. LABELING

The label should indicate the silicon dioxide concentration (for solutions) and its safety and storage conditions.

3. PROPERTIES

Depending on the manner in which they are prepared, acidic solutions are obtained, or alkaline solutions containing sodium ions expressed as Na₂O. Alkaline solutions are most often used.

Colloidal silicon dioxide solutions are free from organic compounds.

Their concentration as determined by drying at 110 °C is always equal to or greater than 15 % (m/m) and is most often between 15 and 30 %.

The density of colloidal silicon dioxide solutions at 20 °C ($\rho_{20^{\circ}\text{C}}$) is given as a function of the concentration C (m/m) by the equation:

$$\rho_{20^{\circ}\text{C}} = \rho_{20^{\circ}\text{C}}(\text{water}) \times 1/(1-0.0056C)$$

$$\rho_{20^{\circ}\text{C}}(\text{water}) = \text{density of water at } 20^{\circ}\text{C} = 0.998203.$$

These preparations are sold in the form of opalescent or milky liquids with slightly bluish tints, or in gel form.

Dried silica gel is sold in the form of a white, free-flowing powder..

4. TESTS

4.1. The solution or powder should have no disagreeable odour or taste.

4.2. pH

Depending on the preparation method and on whether acidic or alkaline solutions are employed, the pH should be between 3 and 4 or between 8 and 10.5.

The pH of silicon dioxide powder should be between 5.0 and 7.5 in 10 % aqueous solution.

4.3. Silicon Dioxide Concentration (Dry Extract at 110 °C)

The weight, P, of the dry residue expressed in g per 100 g of colloidal solution should correspond to within ± 0.5 g of the product's concentration.

For the powder the desiccation loss is determined by drying at 110°C for 4 hours. Weight loss should be not higher than 12 % of the initial weight. Silicon dioxide concentration in the dry powder after desiccation should be above 98%.

4.4. Alkalinity

For alkaline colloidal solutions, determine the alkalinity of a 5 g sample using 0.1M hydrochloric acid (R) in the presence of 2 drops of methyl orange solution (R). Alkalinity expressed in terms of Na₂O for 100 g of product should be less than P/100.

4.5. Preparing the Solution for Tests

Place a volume of colloidal silicon dioxide solution corresponding to 10 g of dry extract or 10 g of dried silicon dioxide powder in a platinum dish 7 cm in diameter and 2.5 cm high. Evaporate until dry. Take up the residue after cooling with 5 ml hydrofluoric acid. Evaporate to dryness. Repeat this procedure until the silicon dioxide residue is eliminated. Evaporate to dryness. Take up the residue using 2 ml concentrated hydrochloric acid (R) and evaporate to dryness. Add 2 ml of concentrated hydrochloric acid (R). Decant in a 50 ml volumetric flask and fill to the mark with distilled water. Safety guidelines for use of concentrated acids have to be respected.

4.6. Heavy Metals

To 5 ml of the test solution prepared under paragraph 4.5, add 5 ml of water, 2 ml of pH 3.5 buffer solution (R) and 1.2 ml of thioacetamide reagent (R).

No precipitate should form. If a color appears it should be less intense than that of a control prepared as indicated in the Annex and filled to a volume of 25 ml.

Heavy metal content, expressed in terms of lead in dry extract form, should be less than 10 mg/kg.

4.7. Lead

Using the technique described in the OIV Compendium of international methods for analysis of wine and must, determine the lead content in the test solution (4.5).

The lead content should be less than 5 mg/kg

4.8. Mercury

Using the technique described in the annex, determine the mercury content in the test solution (4.5).

The mercury content should be less than 1 mg/kg.

4.9. Arsenic

Using the technique described in the annex, determine the arsenic content in the test solution (4.5).

The arsenic content should be less than 3 mg/kg.

4.10. Methanol

Place 50 ml of colloidal silicon dioxide solution in a 200 ml in a round-bottom flask. Distill and collect 50 ml of distillate.

Place 1 ml of distillate in a test tube with 4 drops of 50 % (m/m) orthophosphoric acid (R) and 4 drops of 5 % (m/v) potassium permanganate solution (R). Stir and let sit 10 minutes. Decolorize the permanganate with several drops (typically 8) of 2 % (m/v) of anhydrous potassium sulfite (R), while avoiding any excess. Add 5 ml of sulphuric-acid solution of chromotropic acid (R). Place in a 70 °C water bath for 20 minutes. No violet coloration should appear.

4.11. Formaldehyde

Place 10 ml of the distillate obtained under paragraph 4.10 in a test tube. Add 1 ml of rosaniline hydrochloride solution decoloured with sulfuric acid (R). No pink coloration should appear.

4.12 Medium (d50) and minimum particle size

Medium particle size of silicon dioxide powder should be between 10 and 100 µm measured by laser scattering particle size analyzer after dispersion in demineralized water. Minimum particle size should be above 1 µm.

4.13 Specific surface area (according to BET method)

The BET surface area of silicon dioxide powder is measured by determination of the specific surface area of solid matter by gas adsorption according to ISO 9277:2010.

The specific BET surface area of silicon dioxide powder should be between 300 – 500 m²/g.

5. STORAGE

Colloidal solutions of silicon dioxide should be stored in hermetically sealed containers away from contaminants and at temperatures of above 0 °C (the product freezes at 0 °C with irreversible precipitation of the silicon dioxide).

Silicon dioxide powder should be stored in sealed bags or boxes protected from off odours or humidity.

COPPER SULFATE, PENTAHYDRATE**Copper (II) Sulfate, Pentahydrate** **$\text{CuSO}_4 \cdot 5\text{H}_2\text{O} = 249.68$**

OENO 25/2000

1. OBJECTIVE, ORIGIN AND SCOPE OF APPLICATION

Copper sulfate is used in processing wines possessing so-called reduction "tastes" due to the presence of hydrogen sulfide or volatile thiols.

The copper sulfides thus formed precipitate and should be removed from wine.

This product must be used in compliance with copper sulfate pentahydrate limiting quantities; furthermore, there are statutory limits restricting the copper content in wines.

2. LABELING

The label should indicate product concentration, even when used in mixtures, as well as its safety and storage conditions.

3. PROPERTIES

Blue crystals which are minimally efflorescent in dry air.

4. COMPOSITION

Minimum of 99 pp 100 $\text{CuSO}_4 \cdot 5\text{H}_2\text{O}$.

5. IDENTIFYING CHARACTERISTICS

Melting point: 110 °C with water loss.

An aqueous solution with ammonium hydroxide (R) produces a dark blue copper tetramine compound. A solution acidified with hydrochloric acid and a barium chloride solution (R) produces a white barium sulfate precipitate.

6. SOLUBILITY

Water at 20 °C 286 g/l

Methanol 15.6 g/l

Insoluble in ethanol (95% alcohol by volume).

7. TESTS**7.1. Preparing the Solution for Tests**

Dissolve 10 g of the substance in water and fill to 50 ml.

7.2. Appearance of the Test Solution

The test solution must be clear.

7.3. Iron

Place 2 ml of the solution prepared for tests under paragraph 7.1 in a decanting glass and add 8 ml of water, 10 ml of 6M hydrochloric acid (R) and 10 ml of 4-methylpentane-2-one. Shake vigorously for 3 minutes. After letting the mixture settle, decant the organic phase in a second decanting glass. Add 10 ml of water then shake vigorously again for 3 minutes. Separate out the aqueous phase and perform the test in the following manner:

Add 2 ml of citric acid solution (20 g of citric acid/100 ml), 0.10 ml of concentrated thioglycolic acid (HS-CH₂-COOH) and a small amount of 6M ammonium hydroxide (10-10.4 g NH₃/100 ml) to the aqueous phase until an alkaline reaction is triggered. Dilute with water until a total volume of 20 ml is reached. After 5 minutes, the sample should not be more intensely colored than the test carried out using the comparison solution described below.

*7.3.1 Preparation of the Comparison Solution***Iron (III) and ammonium sulfate solution 1**

Dissolve 0.702 g of ammonium sulfate and iron (III) in 1.20 ml of 6M hydrochloric acid and fill to 100 ml with water.

Iron (III) and ammonium sulfate solution 2

Take 7 ml of ammonium sulfate and iron (III) (Par. 7.3.1.1) and fill to 100 ml with water.

1 ml of solution 2 corresponds to 10 µg of Fe(III).

7.3.2 Test Using the Comparison solution

The comparison solution should be prepared prior to use in the following manner:

Take 1 ml of ammonium sulfate and iron (III) solution (2) and process in the same way as for the substance test.

N.B. : Iron content can also be analyzed by atomic absorption spectrometry, using the method described in the Compendium.

The iron content limit is 100 mg/kg.

7.4. Nickel

Add 2 ml of concentrated hydrochloric acid (R) and 1 ml of concentrated nitric acid (R) to the aqueous phase from paragraph 7.3.

After evaporating the solution, dissolve the residue in 1 ml of 6M nitric acid (R) and 19 ml of water. Dilute 1 ml of this solution to a total volume of 10 ml. To 2.50 ml of this dilute solution, add 6 ml of water (R), 5 ml bromine solution (R), 7 ml of 6M ammonium hydroxide solution and 3 ml of dimethylgloxime solution in a concentration of 100 g in 100 ml of 96% ethanol by volume. The solution should not exhibit any change after one minute when compared to a "blank" sample.

Nickel content can also be determined using the atomic absorption photometry method described in the Annex.

7.5. Chlorides

Dilute 25 ml of the solution prepared for tests under paragraph 7.1 with 10 ml of water. After adding 8 ml of 6M sodium hydroxide, bring to a boil and heat the mixture in a 100 °C water bath until the precipitate has been completely deposited. After cooling, dilute with water to obtain a total volume of 50 ml. Add 6 ml of water to 4 ml of filtrate and conduct the following test: add 1 ml of 6M nitric acid (R) and 1 ml of 0.1M silver nitrate (R). Shake the sample after 5 minutes. There should be no more clouding than that seen in the control test conducted with the comparison solution.

(Limiting value : 100 mg/kg.)

7.5.1 Preparation of the Comparison Solution

Dilute 4 ml of 0.1M sodium chloride solution (23.4 ml/100 ml) with water to yield a total volume of 100 ml. 1 ml corresponds to 142 µg Cl⁻. Prepare the solution just before use.

7.5.2 Control Test with the Comparison Solution

Take 1 ml of the sodium chloride solution (Par. 7.5.1) and proceed in the same manner as for the test on the substance.

7.6. Lead

Using the technique explained in the Compendium, determine the lead content in the test solution (Par. 7.1). (Lead content should be less than 5 mg/kg).

7.7. Mercury

Using the technique explained in the annex, determine the mercury content in the test solution (Par. 7.1). Mercury content should be less than 1 mg/kg.

7.8. Arsenic

Using the technique explained in the annex, determine the arsenic content in the test solution (Par. 7.1). (Arsenic content should be less than 3 mg/kg).

7.9. Quantitative Analysis

Weigh exactly 0.50 g of the substance and dissolve in 20 ml of water. Add 5 ml 6M acetic acid and 2 g potassium iodide. Titrate with a 0.1M sodium thiosulfate solution in the presence of starch (R).

1 ml of a 0.1M sodium thiosulfate solution which corresponds to 6.354 mg of Cu(II), or, if the result is expressed in terms of substance, to 24.97 mg of $\text{CuSO}_4 \cdot 5\text{H}_2\text{O}$.

8. STORAGE

Copper sulfate should be stored in a dry place in hermetically sealed containers.

COPPER CITRATE x 2.5-HYDRATE
Copper citrate hemipentahydrate
 $\text{Cu}_2\text{C}_6\text{H}_4\text{O}_7 \times 2.5 \text{ H}_2\text{O}$
CAS-number: 10402-15-0
molecular weight: 360 g/mol
OIV-OENO 413-2011

1. Subject, origin and field of application

Copper citrate is applied for the treatment of wine to remove fermentation and storage related off-flavours (sulphide off-flavours, flavours caused by reduction reactions, flavours caused by the presence of hydrosulfuric acid and mercaptans).

The copper sulphide formed during the treatment precipitates in wine as it is a very poorly soluble compound and can be separated by filtration.

Addition to the wine can be made directly or preferably by means of bentonite as a carrier material. The purity requirements of Codex resolution OENO 11/2003 apply for the bentonite used.

The addition to the wine is limited (resolution OENO 1/2008), legally permitted limits of copper contents in wine must be respected.

2. Labelling

The product concentration, the batch number, the date of expiry, safety warnings and storage conditions have to be indicated on the label.

3. Appearance

Light green to light blue granulated crystals.

4. Content (Assay)

Minimum of 98 % copper citrate x 2.5-hydrate.

With products on carrier material, a minimum of 2 % copper citrate x 2.5-hydrate.

5. Identification

Copper citrate dissolved in 10 % nitric acid reacts with ammonium hydroxide (R) to form a dark blue complex of tetramine copper.

Heating to dryness at more than 180 °C leads to the carbonization of the citrate.

6. Solubility

Less than 0.05 g/L in water at 20 °C, in methanol and in ethanol.

Approx. 250 g/L in 10 % HCl (R).

Approx. 140-150 g/L in 10 % HNO₃ (R).

7. Tests**7.1 Preparation of the test solution**

Dissolution of 10 g copper citrate in 100 mL 10 % HNO₃ (R).

7.2 Appearance of the test solution

The solution is light blue.

7.3 Iron

Determination by atomic absorption spectrophotometry (AAS); content below 200 mg/kg.

Remark:

The method described in the OIV resolution (OENO 25/2000) leads to a dissolving-out of the iron in the test solution by shaking with 4-methylpentan-2-one and transfer into the organic phase. The iron concentration in the organic phase is not determined. The analysis is merely to test whether the second aqueous phase still contains iron.

By means of AAS, the iron content can be measured directly and precisely.

With a maximum of 200 mg iron per kilogramme of copper citrate and a treatment with at the most 1 g copper citrate per 100 litres of wine, the increase of the iron concentration in wine amounts to a maximum of 0.002 mg per litre and is thus negligible.

7.4 Nickel

Determination by atomic absorption spectrophotometry (AAS); content below 5 mg/kg.

7.5 Chloride

Add 1 mL silver nitrate solution 0.1 M to 4 mL of the test solution. After 5 minutes mix the sample.

The turbidity must not exceed that of the test conducted with the reference solution.

Reference solution:

Dilute 4 mL sodium chloride solution 0.1 M with water to a volume of 100 mL.

Blank test:

1 mL of the freshly prepared reference solution is used instead of the test solution. Proceed in the same way as in the test mentioned above.

Remark:

A pretreatment of the test solution is not necessary, since it is nitric acid.

7.6 Lead

Determination by atomic absorption spectrophotometry (AAS); content below 5 mg/kg.

7.7 Mercury

Determination by atomic absorption spectrophotometry (AAS); content below 1 mg/kg.

7.8 Arsenic

Determination by atomic absorption spectrophotometry (AAS); content below 3 mg/kg.

7.9 Assay

Pour 1 mL test solution, 20 mL water, 2 mL acetic acid 6 M, 2 g potassium iodide and 2 mL starch solution (R) into a titration vessel. Titration is conducted with 0.1 M sodium thiosulphate solution up to the colour change.

A consumption of 1 mL sodium thiosulphate solution corresponds to 6.354 mg Cu(II) or to 18 mg expressed as copper citrate.

8. Storage

Copper citrate must be stored dry, protected from odours in hermetically closed packaging.

D,L-TARTARIC ACID
D,L-2,3-dihydroxybutanedioic Acid
Racemic Acid
Acidum tartaricum
COOH - CHOH - CHOH - COOH
C₄H₆O₆ = 150.1
AG 3/80-OEN;
OENO 48/2000;
OENO 4/2007

1. OBJECTIVE, ORIGIN AND SCOPE OF APPLICATION

This product is used to eliminate excess calcium from wines and musts under certain conditions. The calcium racemate that is produced yields particularly insoluble salts. Its use is subject to certain regulations.

2. LABELING

The label should cite the purity percentage and storage requirements.

It should also clearly indicate that the product is a racemic mixture of the two isomers D and L of tartaric acid, so as to avoid suggesting that the product is the L-tartaric acid occurring naturally in grapes.

3. PROPERTIES

Colorless, transparent extremely solid crystals having a distinctly acidic taste. Instantaneous melting point is 206 °C¹.

4. SOLUBILITY

Water at 20 °C	245 g/l
Water at 100 °C	1428 g/l
Alcohol, 95% by vol.	26 g/l
Ethyl ether	14.9 g/l

5. IDENTIFYING CHARACTERISTICS

5.1. Verify total solubility in water. A 1% solution exhibits an acidic reaction with respect to methyl orange (R). This solution has no rotatory power.

5.2. Add 2 ml of 25% calcium acetate solution (R) to 5 ml of 1% (m/v) solution. An abundant white crystalline precipitate should form

¹ Due to a printing error the value of the melting point has been corrected

instantaneously. Under these conditions, L(+) tartaric acid (dextrorotatory tartaric acid) yields no precipitate.

5.3. Add 2 ml 5% potassium acetate solution (R) to 5 ml of 10% (m/v) solution. A crystalline precipitate will form.

6. TESTS

6.1. Foreign Substances

D,L tartaric acid should be soluble without residue in 10 times its weight of water.

6.2. Sulfur Ash

As analyzed in 2.0 g D,L tartaric acid, the sulfur ash content should not be greater than 0.2 pp 100.

6.3. Preparing the Solution for Tests

Dissolve 10 g D,L-tartaric acid in water and fill to 100 ml with the same solvent.

6.4. Citric Acid

Add 5 ml of water and 2 ml mercury (II) sulfate solution (R) to 5 ml of the solution prepared for tests under Paragraph 6.3. Bring to a boil and add several drops potassium permanganate solution (concentration: 2 pp 100) (R). No white precipitate should form.

6.5. Chlorides

Add 14.5 ml of water, 5 ml of dilute nitric acid (R) and 0.5 ml of 5 pp 100 silver nitrate solution (R) to 0.5 ml of the solution prepared for tests under Paragraph 6.3. The solution should meet the chloride limit test described in the Annex. (Chloride content expressed as hydrochloric acid should be less than 1 g/kg).

6.6. Iron

Add 1 ml of concentrated hydrochloric acid (R) and 2 ml of 5 pp 100 potassium thiocyanate solution (R) to 10 ml of the solution prepared for tests under paragraph 6.3. The resulting red coloration should be less intense than that observed in a control prepared using 1 ml of an iron (III) salt solution in a concentration of 0.010 g of iron per liter, 9 ml of water and the same quantities of the same reagents. (Iron content should be less than 10 mg/kg).

Iron content may also be determined by atomic absorption spectrometry in accordance with the method described in the Compendium.

6.7. Lead

Use the method described in the Compendium to analyze the test solution (6.3). (Content to be less than 2 mg/kg.)

6.8. Mercury

Using the technique described in the Annex, determine the proportion of mercury in the test solution (6.3). (Mercury content should be less than 1 mg/kg).

6.9. Arsenic

Using the technique described in the Annex, determine the proportion of arsenic in the test solution (6.3). (Arsenic content should be less than 3 mg/kg).

6.10. Sulfates

Add 18 ml of water, 1 ml hydrochloric acid diluted to 10 pp 100 (R) and 2 ml of 10 pp 100 barium chloride solution (R) to 1 ml of the solution prepared for tests under Paragraph 6.3. The solution should meet the sulfate limit test described in the Annex. (Concentration of sulfate expressed as sulfuric acid should be less than 1 g/kg).

6.11. Oxalate

Using the technique described in the Annex, determine the proportion of oxalate in the test solution (6.3). (Oxalate content expressed as oxalic acid should be less than 100 mg/kg after desiccation).

7. QUANTITATIVE ANALYSIS

Dissolve a precisely-weighed sample **p** of approximately 1 g D,L-tartaric acid in 10 ml of water. Titrate with 1M sodium hydroxide solution in the presence of phenolphthalein (R). Let **n** be the number of milliliters used.

1 ml of 1M sodium hydroxide solution corresponds to 0.075 g D,L-tartaric acid.

Content, in percent, of D,L-tartaric acid of the product tested: $7.5 \mathbf{n}$.

Products used in wine-making must contain a minimum of 99 pp 100 D,L-tartaric acid (dry product).

8. STORAGE

D,L-tartaric acid should be stored in hermetically sealed containers.

**DIAMMONIUM HYDROGEN PHOSPHATE
AMMONIUM HYDROGEN PHOSPHATE*****Ammonii phosphas*
(NH₄)₂HPO₄ = 132.1****SIN NO. 342**

OENO 15/2000

1. OBJECTIVE, ORIGIN AND SCOPE OF APPLICATION

This product is used as a fermentation activator and is reserved for fermentation operations. It makes available ammonium ions, which can be directly assimilated by the yeast. Excess phosphates can lead to iron breakdown.

Statutory provisions limit the amount of ammonium that can be added.

2. LABELING

The concentration of this product should be indicated on the label, including cases of mixtures. In addition, safety and storage conditions should also be stipulated.

3. CENTESIMAL COMPOSITIONH₃PO₄ 74.21P₂O₅ 53.75NH₃ 25.79**4. PROPERTIES**

Colorless, monoclinic crystals. This salt slowly loses small quantities of ammonia in air.

5. SOLUBILITY

Water at 20 °C 689 g/l

Water at 100 °C 1060 g/l

Alcohol, 95% by vol. insoluble

6. IDENTIFYING CHARACTERISTICS

6.1. Prepare a 1 pp 100 (m/v) solution in water. The solution has a pH of approximately 8, and a slight pink color is produced with several drops of phenolphthalein (R). At 25 °C, the pH of this solution should be between 7.8 and 8.4.

6.2. This solution produces a yellow precipitate with a nitro-molybdic reagent (R).

6.3. When heated with several drops of 30% sodium hydroxide solution (R), this solution releases ammonia.

7. TESTS

7.1. Sulfur Ash

Quantified as indicated in the Annex, the proportion of diammonium phosphate ash should not be greater than 5 g/kg.

7.2. Preparing the solution for tests

Prepare a 10 pp 100 (m/v) solution.

7.3. Chlorides

To 0.5 ml of the solution prepared for testing under Paragraph 7.2, add 14.5 ml of water, 5 ml of nitric acid diluted to 10 pp 100 (R) and 0.5 ml of 5 pp 100 silver nitrate solution (R). After 15 minutes at rest in the dark, there should be no clouding, or any clouding visible should be less intense than that observed in the control prepared as detailed in the annex. (Hydrochloric acid content is less than 1 g/kg).

7.4. Sulfates

To 1 ml of solution prepared for tests under paragraph 7.2, add 2 ml of dilute hydrochloric acid (R), 17 ml of water and 2 ml of barium chloride solution (R). The mixture must not form any precipitate or any opalescence ; or else, any opalescence that does occur should be less intense than that observed in the control prepared as indicated in the Annex. (Sulfuric acid content should be less than 1 g/kg).

7.5. Oxalic acid

To 5 ml of solution prepared for tests under paragraph 7.2, add 20 drops of acetic acid (R) and 5 ml of solution saturated with calcium sulfate (R). The solution should remain clear.

7.6. Iron

To the 5 ml of solution prepared under paragraph 2, add 1 ml of concentrated hydrochloric acid (R) and 1 ml of 5 pp 100 potassium thiocyanate solution (R).

Coloring should be less intense than that of a control prepared with 2.5 ml of an iron solution in a concentration of 10 mg of iron per liter (R), 2.5 ml of water and the same quantities of the same reagents. (Iron content should be less than 50 mg/kg.)

Iron may also be analytically quantified by atomic absorption spectrometry, according to the method specified in the Compendium.

7.7. Lead

By implementing the method detailed in the Compendium, carry out quantitative analysis of the solution prepared for testing according to Paragraph 7.2. (Lead content should be less than 5 mg/kg).

7.8. Mercury

Test for mercury in the solution prepared for testing (Par. 7.2), in accordance with the method detailed in the Compendium. (Mercury content should be less than 1 mg/kg.)

7.9. Arsenic

Using the method indicated in the Annex, test for arsenic in 2 ml of the test solution prepared in accordance with paragraph 7.2. (Arsenic content should be less than 3 mg/kg.)

7.10. Quantitative Ammonia Analysis

Dilute the solution prepared under Paragraph 7.2 to one-tenth strength, then place 10 ml of this dilute solution (0.10 g of ammonium phosphate) in a steam distillation device (described in the Annex). Add 10 ml of water, 10 ml of 30% sodium hydroxide (R) and distill 10 ml. Analytically quantify the distilled ammonia using 0.1 M hydrochloric acid. Let n be the number of milliliters used:

100 g of ammonium phosphate contains 1.7 n g of ammonia (NH_3). (Minimum content is 25 pp 100).

7.11. Quantitative Analysis of Phosphoric Acid

Place 25 ml of the solution prepared under paragraph 7.2 in a conical flask. Add 5 drops of phenolphthalein (R). The solution should have a pale pink color. If not, add just enough 0.1 M sodium hydroxide solution to cause incipient movement of the indicator. Add 10 drops of bromocresol green (R) and use a burette to pour 0.5 M sulfuric acid until the indicator turns green.

Let n be the volume in ml used:

One liter of 0.5 M solution corresponds to 71 g of phosphoric anhydride or 98 g of phosphoric acid.

Proportion of ammonium phosphate in g per 100 g :

- in phosphoric anhydride 2.84 n
- in phosphoric acid 3.92 n

The proportion of phosphoric anhydride must range between 51.6 and 55 pp 100, or between 71.5 and 76 pp 100 of phosphoric acid.

8. STORAGE

Ammonium phosphate must be stored away from moisture and heat, and in hermetically sealed containers.

DIATOMITE
Kieselguhr
Terra silicea
OENO 10/2002

1. OBJECT, ORIGIN AND FIELD APPLICATION

Diatomite is a sedimentary rock made up of siliceous shells (tests) of diatomite fossils (unicellular microscopic algae). For enological purposes, this rock is crushed, dried, shredded, purified through cleaning, and calcinated at a high temperature of 950 to 1000°C. Melted alkali can be added during the calcination process.

It is used when pulverised with a granulometer between 5 to 40 microns and can be found in a pink powder form for calcinated products or white for calcinated activated products.

Diatomite is a filter aid for musts and wine. The usage of diatomite requires wearing a protective mask.

2. LABELLING

The label must indicate granulometry, permeability, the specifications of accompanying documents in addition to the storage and safety conditions.

3. TEST TRIALS

3.1 Odour and taste

Diatomite should not carry any odour or foreign taste to the wine. Put 2.5 g of diatomite in a litre of wine. Mix. Leave 24 hours. Compare the taste to wine not containing any diatomite.

3.2 Loss during drying

Put 5 g of diatomite in a capsule. Heat in an incubator to $103 \pm 2^\circ\text{C}$. After two hours mass loss should not be more than 1%.

3.3 Loss through calcinations

Bring the dry residue obtained in point 3.2 to 550°C in a furnace. Weight loss should not be more than 3%.

3.4 Measure pH level

In a 250 ml container put approximately 10 g of diatomite, then slowly add 100 ml of water to moisten the product and to get a homogeneous suspension. Mix by hand from time to time using a magnetic mixer. After 10 minutes, let the suspension settle and measure the pH. Calcinated diatomites (pink) have a pH level between 5 to 7.5 and activated calcinated diatomites (white) have a pH level between 6 to 10.5.

3.5 Soluble products in diluted acids

Bring to a boil 10 g of dried diatomite with 20 ml of concentrated hydrochloric acid (R) and 100 ml of water. Collect the diatomite on an ashless filter paper and wash the residue with 100 ml of distilled water. After desiccation at 100-105°C and incineration, separate the filter of insoluble residue, which should weigh at least 9.8 g and constitute 98% of the dried product.

3.6 Preparation of test solution

In a 500 ml flask, which can be hermetically sealed, put 200 ml of citric acid solution at 5 g per litre bring to pH 3 (R) and 10 g of diatomite. Put this in a magnetic mixer and mix for 1 hour at a temperature of $20 \pm 2^\circ\text{C}$. Allow to settle and filter by eliminating the first 50 ml of filtrate. Collect at least 100 ml of clear liquid.

3.7 Iron

On the test solution prepared according to point 3.6, determine the iron following the procedure described in Chapter II. Iron content must be less than 300 mg/kg.

3.8 Lead

On the test solution prepared according to point 3.6, determine the lead following the procedure described in Chapter II. Lead content must be less than 5 mg/kg.

3.9 Mercury

On the test solution prepared according to point 3.6, determine the mercury following the procedure described in Chapter II. Mercury content must be less than 1 mg/kg.

3.10 Arsenic

On 4 ml of test solution prepared according to point 3.6, determine the arsenic following the procedure described in Chapter II. Arsenic content must be less than 3 mg/kg.

4. STORING CONDITIONS

Diatomite must be stored in dry well ventilated places or in vacuumed packed sealed bags in a temperate place.

DIMETHYL DICARBONATE (DMDC)

Dimethyl pyrocarbonate

N° SIN = 242

C.A.S 004-525-33-1

OENO 25/2004;

modified by OENO 4/2007

EINECS 224-859-8

Chemical formula: $C_4H_6O_5$
 $H_3C-O-(C=O)-O-(C=O)-O-CH_3,$

Molecular weight 134.09

1. OBJECT, ORIGIN AND FIELD OF APPLICATION

Antiseptic mainly active against yeast. Synthetic product.

2. LABELLING

The name "Dimethyl dicarbonate", the batch number, the date of expiry, storage temperature (20°C–30°C) and safety precautions must be indicated on the label.

3. CHARACTERISTICS

Colourless liquid that decomposes in an aqueous solution. Corrosive for skin and eyes. Toxic in case of inhalation and ingestion.

After dilution in water, CO_2 is formed which can be characterised.

Melting point: 17°C.

Boiling point: 172°C with decomposition.

Density at 20°C: about 1.25.

Infrared spectrum: maximum absorption at 1156 nm and 1832 nm.

4 CHARACTERISATION

4.1 Principle of the method

The sample is mixed with an excess of dibutylamine with which it reacts directly. The excess of amine is determined by back titration.

4.2 Apparatus

- 4.2.1 150 ml cylindrical vase
- 4.2.2 100 ml graduated test tube
- 4.2.3 20 ml pipette
- 4.2.4 Glass electrode/reference electrode
- 4.2.5 pH metre
- 4.2.6 20 ml plunger burette
- 4.2.7 Magnetic stirrer
- 4.2.8 2 ml disposable syringe.

4.3 Reagents

- 4.3.1 Pure acetone
- 4.3.2 Dibutylamine solution [$C_8H_{19}N$] = 1 mole/l
Weigh 128 g of dibutylamine into a 1 l volumetric flask and fill to the mark with chlorobenzene.
- 4.3.4 Molar hydrochloric acid solution [HCl] = 1 mole/l
Determine the mass concentration by titration with sodium carbonate. Titre: t
- 4.3.5 Anhydrous sodium carbonate, dried in incubator at 110°C.

4.4 Procedure

Pour about 70 ml of acetone (4.3.1) in a 150 ml cylindrical vase. Place a cylindrical vase (4.2.1) and introduce 1.0 to 1.3 g (W) of sample by using a disposable syringe (4.2.8) (precision of ± 0.1 mg).

Add exactly 20 ml of the dibutylamine solution (4.3.2) using a pipette (4.2.3) and shake vigorously.

4.4.1 Titrate by potentiometry the excess of amine with hydrochloric acid (4.3.4).

Consumption of HCl solution = V1 ml.

4.4.2 Perform a control trial according to 4.4 but without adding the sample.

Consumption of HCl solution = V2 ml.

4.5 Result

$$\frac{(V2-V1) \cdot t \cdot 134.1 \cdot 100}{1000 \cdot W} = \frac{(V2-V1) \cdot t \cdot 13.41}{W} = \% \text{ dimethyl dicarbonate}$$

DMDC content should be more than or equal to 99.8%.

5. DMDC HEAVY METAL, CONTENT (EXPRESSED IN LEAD), MERCURY AND CHLORIDE

5.1 Buffer solution, pH= 3.5 Dissolve 6.25 of ammonium acetate in 6 ml water. Add 6.4 ml of hydrochloric acid and dilute water to 25 ml.

5.2 Solution for trials: Pour 5 ml of buffer solution in a conical flask, 25.0 g of sample and approximately 15 ml of water. Let the sample hydrolyze for 3 days, shaking from time to time. Transfer the solution to a 50 ml graduated cylinder and fill up with water to indicator.

5.3 Heavy metals

Determine the heavy metal content according to the method in chapter II of the International Oenological Codex.

The contents of heavy metals must be less than 10 mg/kg.

5.4 Mercury

Using the solution for trials (5.2) measure the mercury according to the method in chapter II of the International Oenological Codex.

The contents of mercury must be less than 1 mg/kg.

5.5 Chloride

Using the trial solution 5.2 (diluted two times compared to initial contents) measure the chloride according to the method in chapter II of the International Oenological Codex.

The contents of chloride must be less than 3 mg/kg.

6. DETERMINATION OF ARSENIC, LEAD AND CADMIUM BY ATOMIC ABSORPTION SPECTROMETRY

6.1 Preparation of the test trial solution

For the determination of arsenic, lead, and cadmium.

Weigh about 100 g of the sample with a precision of ± 0.1 g in a cylindrical vase.

Add 200 ml of water and 5 ml of pure sulphuric acid (R) and concentrate on a hot plate until the first vapours of sulphuric acid appear.

Re-dilute the solution with water and add 1 ml of pure hydrochloric acid (R). Pour while washing into a 50 ml volumetric flask and bring to mark.

6.2 Arsenic

Using the trial solution (6.1) determine the arsenic content according to the method in chapter II of the International Oenological Codex.

Arsenic content should be less than 3 mg/kg.

6.3 Lead

Using the trial solution (6.1), determine the lead content according to the method in chapter II of the International Oenological Codex.

Lead content should be less than 2 mg/kg.

6.4 Cadmium

Using the trial solution (6.1), determine the cadmium content according to the method in chapter II of the International Oenological Codex.

Cadmium content should be less than 0.5 mg/kg.

7. DETERMINATION OF DIMETHYL CARBONATE

Dimethyl carbonate content should be less than 0.2%.

7.1 Principle of the method

The concentration of dimethyl carbonate is determined by chromatography in gaseous phase. The quantitative evaluation is performed by using methyl-isobutylcetone as an internal standard.

7.2 Apparatus

7.2.1 Chromatograph in gaseous phase with a flame ionisation detector and capillary column (apolar type "SE 30" or other; a polar column can also be used such as the Carbowax type 20 M), 50 m x 0.3 mm.

7.2.2 Data acquisition system.

7.2.3 A 10 µl quartz needle syringe suitable for an on column injection (injection "on column" (cf. remark 7.7).

7.2.4 10 ml antibiotic flask with a Teflon stopper that can be sealed with a aluminium capsule with the top part that can be torn off.

7.3 Internal standard

Ultra pure methyl-isobutylcetone.

7.4 Procedure

7.4.1 Weigh about 1 g of the sample at ± 1 mg (W1 mg) in a flask 7.2.4.

7.4.2 Add a quantity of internal standard (W2 mg) of methyl-isobutylcetone (7.3) corresponding to 10 mg/kg after addition (10 µl for example).

7.4.3 Seal the flask, mix vigorously and inject 0.2 µl.

7.4.4 Determine the peak area corresponding to the internal standard (F 2) and corresponding to dimethyl carbonate (F 1).

7.5 Result

$$\frac{W2 \cdot F1 \cdot K \cdot 100}{F2 \cdot W1} = \% \text{ mass of dimethyl carbonate}$$

K = Factor for the dimethyl carbonate calculated using reference solutions of this substance preferably prepared in DMDC free from dimethyl carbonate.

7.6 Remark 1

The sample prepared with the standard should be immediately analysed.

7.7 Remark 2

A partial decomposition of DMDC can occur when in contact with the metal needles of traditional syringes.

8. STORAGE

The DMDC must be stored in perfectly watertight containers at a temperature between 20°C and 30°C. Its shelf life is 12 months.

EGG (ALBUMIN OF)

Ovalbumin

Albumen ovi

OENO 32/2000;

OENO 650-2019

1. OBJECTIVE, ORIGIN AND SCOPE OF APPLICATION

The albumin of an egg is obtained by desiccating fresh egg whites. It is found in the form of a fine, white, very light powder which is not completely soluble in water, but is soluble in certain alkaline solutions.

Fining agent for clarifying wines.

Egg albumin is sold in powder or spray form, or it may be used directly in the form of albumin from fresh or sterilized eggs.

Egg albumin is precipitated by tannin. Typically, 2 g of pure tannin are required to precipitate 1 g of egg albumin.

2. LABELING

The label should indicate the storage, hygienic, and safety conditions, as well as the optimal use-by date.

3. DETERMINATION OF IDENTIFYING PROPERTIES

3.1. Preparation of a 10g/l Solution and Properties

3.1.1 Prepare an egg albumin slution by weakening the power with a very small quantity of water, so as to give a homogenous paste. Next, weaken gradually in order to obtain a solution having a concentration of 10g/l. This solution must have no unpleasant taste or odor.

This solution will have a pH of between 6.5 and 7. It will foam abundantly when shaken and will coagulate when heated in the presence of neutral salts.

Ovalbumin precipitate from its solutions by ammonium sulfate dissolved at saturation, by nitric acid and by alcohol

3.1.2 The pH of albumin from fresh eggs ranges between 8.5 and 9.5.

3.2. Disclosure of the Presence of Gum, Dextrin, and Gelatin

To 10 ml of a solution (concentration : 10 g/l) (Par. 3.1), add 0.5 ml concentrated nitric acid (R). Heat to 50-60°. A precipitate will form. Allow to cool, then filter. The filtrate should be colorless and clear, and should not become colored when an iodo-iodized solution (R) is added. No opalescent ring should form when 5 ml filtrate and 5 ml alcohol at 95% by volume are placed one on top of the other without mixing.

3.3. Desiccation Loss

In a 70 mm diameter silica dish with cover, place 2 g egg albumin. Dry in an oven at 100-105° for 6 hours. Allow to cool in the uncovered dish in a drying apparatus. Weigh. Let **p** be the quantity of dry residue. Weight loss should not exceed 10 pp 100.

When albumin from fresh egg is used, the real dry extract must be greater than 10.5%.

All of the limiting values given above are for dry product.

3.4. Ash

Incinerate the dry residue obtained from the test (Par. 3.4) by gradually heating to 600° C in a muffle furnace, after dusting the egg albumin with 0.2 to 0.3 g paraffin without ash, in order to prevent the material mass from overflowing.

The proportion of ash must not exceed 6.5 pp 100.

3.5. Total Nitrogen

Total nitrogen is determined using the technique described in the annex. The total nitrogen content must exceed 12 pp 100.

4. TESTS**4.1. Preparation of the Test Solution**

After weighing, dissolve the ash in 2 ml concentrated hydrochloric acid (R) and 10 ml water. Heat to trigger dissolution and added distilled water to obtain a volume equal to 25 times the weight of the dry egg albumin.

l of this solution contains the mineral substances from 0.04 g dry egg albumin.

4.2. Heavy metals

To 10 ml of the test solution prepared according to Par. 4.1, add 2 ml of a buffer solution (pH : 3.5 (R)) and 1.2 ml thioacetamide reagent (R). No precipitate should form. If the mixture becomes colored, the coloration should be less intense than that of the control prepared as indicated in the annex. (heavy metals content, expressed with respect to lead, should be less than 10 mg/kg.)

4.3. Arsenic

Using the technique described in the annex, determine arsenic content in the test solution (Par. 4.1). Content I should be less than 3 mg/kg.

4.4. Lead

Using the technique described in the Compendium, determine lead content in the test solution (Par. 4.1). Content I should be less than 5 mg/kg.

4.5. Mercury

Using the technique described in the annex, determine mercury content in the test solution (Par. 4.1). Content I should be less than 1 mg/kg.

5. STORAGE

Egg albumin should be stored in packages which ensure effective protection from moisture and external contamination in places in which temperatures are moderate.

ELECTRODIALYSIS MEMBRANES

OENO 5/95 ;
OENO 29/2000

1. OBJECTIVE, ORIGIN AND SCOPE OF APPLICATION

An electrodialysis membrane is a thin, dense, insoluble wall composed of a polymer material that is permeable to ions. When placed between two solutions, it allows the selective transfer of ions from one solution to the other when acted upon by an electric field.

The membrane pair consists of a cationic membrane and an anionic membrane.

The cationic membrane is a polymer which allows the preferred flow of cations, in particular the K^+ and Ca^{++} cations.

The anionic membrane is a polymer which allows the preferred flow of anions, in particular tartrate anions.

Electrodialysis membranes are used to stabilize wine in the event of tartaric precipitation.

2. COMPOSITION

The cation-exchange membrane that can be used is a styrene-divinylbenzene copolymer which carries sulfonic functional groups.

The anion-exchange membrane that can be used is either:

A styrene-divinylbenzene copolymer which carries quaternary ammonium functional groups, or

A quaternary ammonium-divinylbenzene copolymer.

Electrodialysis membranes used for tartaric stabilization in wine should meet the following requirements:

2.1. They should be manufactured in accordance with the good manufacturing practices for the substances enumerated in :

2.1.1 *Annex 1* pertaining to materials placed in contact with foodstuffs

2.1.2. *Annex 2 and Annex 3* pertaining to ion-exchange resins used in processing foodstuffs

2.2. They should be prepared to serve their intended function, in accordance with the instructions of the manufacturer or supplier.

2.3. They should not release any substance in a quantity which poses a human health threat or which alters the taste or odor of foodstuffs.

2.4. In use, there should be no interaction between the constituents of the membrane and those of the wine that could form new compounds in the product that could produce toxicological consequences.

The stability of new electrodialysis membranes shall be established using a simulator which reproduces the physicochemical properties of wine, in order to study the migration of certain substances given off by the electrodialysis membrane.

The proposed experimental method is as follows:

Composition of the simulator:

This is an hydro-alcoholic solution with the pH and conductivity of wine. It is composed of the following:

- Absolute ethanol: 11 liters
- Potassium hydrogen tartrate: 380 g
- Potassium chloride: 60 g
- Concentrated sulfuric acid: 5 ml
- Distilled water: quantity sufficient for 100 liters

This solution is used to test migration in a closed circuit on a live electrodialysis stack (1 volt/cell) in a proportion of 50 liters/m² of anionic and cationic membranes until the solution is 50% demineralized. The effluent circuit is activated by a 5 g/l potassium chloride solution.

The migrating substances tested for in the simulator and in the electrodialysis effluent.

The organic molecules forming a constituent of membrane and which can migrate into the treated solution will be quantitatively analyzed.

A specific determination for each of these constituents will be carried out in an approved laboratory. The content in the simulator must be less than the total, for all compounds analyzed at 50 µg/l.

Generally, the rules governing materials used in contact with foodstuffs shall also apply to these membranes.

3. LIMITS ON USE

The membrane pair used for tartaric wine-stabilization processing using electrodialysis is specified in such a way that:

- the pH reduction in the wine is no greater than 0.3 pH units ;
- volatile acid reduction is less than 0.12 g/l (2 meq. expressed in acetic acid) ;
- electrodialysis-based processing does not affect the non-ionic constituents of the wine, in particular the polyphenols and polysaccharides ;
- the diffusion of small molecules such as ethanol is reduced and does not lead to a reduction of alcoholic content greater than 0.1%.

4. CONDITIONS OF USE

These membranes should be stored and cleaned using accepted techniques and substances whose use is authorized for the preparation of foodstuffs.

INTERNATIONAL CENOLOGICAL CODEX**Electrodialysis Membranes**

COEI-1-MEMELE: 2000

Annex 1

List of monomers and other starting substances that can be used in the manufacture of plastic materials and devices designed to be placed in contact with foodstuffs, products, and beverages.

LIST OF APPROVED MONOMERS AND OTHER STARTING SUBSTANCES

PM/REF No.	Case No.	Name	Restrictions
(1)	(2)	(3)	(4)
10030	000514-10-3	Abietic acid	
10060	000075-07-0	Acetaldehyde	
10090	000064-19-7	Acetic acid	
10120	000108-05-4	Vinyl acetate	SML = 12 mg/kg
10150	000108-24-7	Acetic anhydride	
10210	000074-86-2	Acetylene	
10630	000079-06-1	Acrylamide	SML = ND (DL = 0.01 mg/kg)
10660	015214-89-8	2-acrylamido-2-methylpropane-sulfonic acid	SML = 0/05 mg/kg
10690	000079-10-7	Acrylic acid	
10750	002495-35-4	Benzyl acrylate	
10780	000141-32-2	n-butyl acrylate	
10810	002998-08-5	Sec-butyl acrylate	
10840	001663-39-4	Tert-butyl acrylate	
11470	000140-88-5	Ethyl acrylate	
	000818-61-1	Hydroxyethyl acrylate	See « Ethylene glycol monoacrylate »
11590	00106-63-8	Isobutyl acrylate	
11680	00689-12-3	Isopropyl acrylate	
11710	000096-33-3	Methyl acrylate	
11830	000818-61-1	Ethylene glycol monoacrylate	
11890	002499-59-4	n-octyl acrylate	
11980	000925-60-0	Propyl acrylate	

INTERNATIONAL GENOTOXICOLOGICAL CODEX

Electrodialysis Membranes

COEI-1-MEMELE: 2000

PM/REF N°	Case N°	Name	Restrictions
12100	000107-13-1	Acrylonitrile	LMS = ND (LD = 0,020 mg/kg) (including analytic tolerance)
12310		Albumin	
12340		Albumin coagulated by formaldehyde	
12375		Saturate, linear, primary monhydric alcohols (C ₄ -C ₂₂)	
12670	002855-13-2	1-amino-3-aminomethyl-3,5,5-trimethylcyclohexane	SML = 6 mg/kg
12788	002432-99-7	11-aminoundecanoic acid	SML = 5 mg/kg
12789	007664-41-7	Ammonia	
12820	00123-99-9	Azelaic acid	
12970	004196-95-6	Azelaic anhydride	
13000	001477-55-0	1,3-benzene dimethanamine	SML = 0.05 mg/kg
13090	000065-85-0	Benzoic acid	
13150	000100-51-6	Benzylid acid	
	000111-46-6	Bis(2-hydroxyethyl)ether	See Diethylene glycol
	000077-99-6	2,2-bis(hydroxymethyl)-1-butanol	See 1,1,1-trimethylolpropane
13390	000105-08-8	1,4-bis(hydroxymethyl)cyclohexane)	
13480	000080-05-7	2,2-bis(4-hydroxyphenyl)propane	SML = 3 mg/kg
13510	001675-54-3	Bis(2,3-epoxypropyl) ether of 2,2-bis(hydroxyphenyl) propane	MQ = 1 mg/kg PF or SML = non-detectable (DL = 0.020 mg/kg, including analytic tolerance)
	000110-98-5	Bis(hydroxypropyl) ether	See Dipropylene glycol
	005124-30-1	Bis(4-isocyanato-cyclohexyl) methane	See 4,4-Diisocyanate dicyclohexylmethane
13530	038103-06-9	Bis(phthalic anhydride) of 2,2-bis(4-hydroxyphenyl) propane	SML = 0.05 mg/kg
13600	047465-97-4	3,3-bis(3-methyl-4-hydroxyphenyl)-2-indolinone	SML = 1.8 mg/kg
	000080-05-7	Bisphenol A	See 2,2-bis(4-hydroxyphenyl)propane
	001675-54-3	Bis(2,3-epoxypropyl)ether of bisphenol A	See Bis(2,3-epoxypropyl)ether of 2,2-bis(4-hydroxyphenyl) propane
13614	038103-06-9	Bis (phthalic anyhydride)of bisphenol	See 13530

INTERNATIONAL GENOLOGICAL CODEX

Electrodialysis Membranes

COEI-1-MEMELE: 2000

PM/REF N°	Case N°	Name	Restrictions
13630	000106-99-0	Butadiene	MQ = 1 mg/kg of PF or SML = non-detectable (DL = 0.02 mg/kg, including analytic tolerance)
3690	000107-88-0	1,3-butanediol	
13840	000071-36-3	1-butanol	
13870	000106-98-9	1-butene	
13900	000107-01-7	2-butene	
14110	000123-72-8	Butyraldehyde	
14140	000107-92-6	Butyric acid	
14170	000106-31-0	Butyric anhydride	
14200	000105-60-2	Caprolactam	SML(T) = 15 mg/kg
14230	002123-24-2	Caprolactam, sodium salt	SML(T) = 15 mg/kg (expressed in terms of caprolactam)
14320	0001207-2	Caprylic acid	
14350	00630-08-0	Carbon monoxide	
14380	000075-44-5	Carbonyl chloride	MQ = 1 mg/kg in FP
14411	008001-79-4	Castor oil	
14500	009004-34-6	Cellulose	
14530	007782-50-5	Chlorine	
	000106-89-8	1-chloro-2,3-epoxy propane	See Epichlorhydrin
14680	000077-92-9	Citric acid	
14710	000108-39-4	<i>m</i> -cresol	
14740	000095-48-7	<i>o</i> -cresol	
14770	00106-44-5	<i>p</i> -cresol	
	00105-08-8	1,4-cyclohexanedi-methanol	See 1,4-bis(hydroxymethyl) cyclohexane
14950	003173-53-3	Cyclohexyl isocyanate	MQ(T) = 1 mg/kg in FP (expressed as NCO)
15070	001647-16-1	1,9-decadiene	SML = 0.05 mg/kg
15095	000334-48-5	Decanoic acid	
15100	000112-30-1	1-decanol	

INTERNATIONAL CENOLOGICAL CODEX

Electrodialysis Memranes

COEI-1-MEMELE: 2000

PM/REF N°	Case N°	Name	Restrictions
	000107-15-3	1,2-diaminoethane	See Ethylenediamine
	000124-09-4	1,6-diaminohexane	See Hexamethylene- diamine
15250	000110-61-1	1,4-diaminobutane	
15565	0000106-46-7	1,4-dichlorobenzene	SML == 12 mg/kg
15700	005124-30-1	Icyclohexylmethane-4,4'-diisocyanate	MQ(T) - 1 mg/kg in FP (expressed as NCO)
15760	000111-46-6	Diethylene glycol	SML(T) = 30 mg/kl alone or with ethylene glycol
15790	000111-46-6	Diethylene triamine	SML = 5 mg/kg
15820	000345-92-6	4,4'-difluorobenzo-phenone	SML = 0.05 mg/kg
15880	000120-80-9	1,2-dihydroxybenzene	SML = 6 mg/kg
15910	000108-46-3	1,3-dihydroxybenzene	SML = 2.4 mg/kg
15940	000123-31-9	1,4-dihydroxybenzene	SML = 0.6 mg/kg
15970	000611-99-4	4,4'-dihydroxybenzo-phenone	SML = 6 mg/kg
16000	000092-88-6	4,4'-dihydroxydiphenyl	SML = 6 mg/kg
16150	000108-01-0	Dimethylaminoethanol	SML = 18 mg/kg
16240	000091-97-4	3,3'-dimethylbiphenyl-4,4'-diisocyanate	MQ(T) = 1 mg/kg in FP (expressed as NCO)
16480	000126-58-9	Dipentaerythritol	
16570	004128-73-8	4,4'-diisocyanate of diphenyl ether	MQ(T) = 1 mg/kg in FP (expressed as NCO)
16600	005873-54-1	Diphenylmethane-2,4'-diisocyanate	MQ(T) = 1 mg/kg in FP (expressed as NCO)
16630	000101-68-8	Diphenylmethane-4,4'-diisocyanate	MQ(T) = 1 mg/kg in FP (expressed as NCO)
16660	000110-98-5	Dipropylene glycol	
16750	000106-89-8	Epichlorhydrin	MQ = 1 mg/kg in FP
16780	000064-17-5	Ethanol	
16950	000074-85-1	Ethylene	
16960	000107-15-3	Ethylenediamine	SML = 12 mg/kg
16990	000107-21-1	Ethylenje glycol	SML(T) = 30 mg/kg alone or with diethylene glycol

INTERNATIONAL GENOLOGICAL CODEX

Electrodialysis Membranes

COEI-1-MEMELE: 2000

PM/REF N°	Case N°	Name	Restrictions
17005	000151-56-4	Ethyleneimine	SML = ND (DL = 01 mg/kg)
17020	000075-21-8	Ethylene oxide	MQ = 1 mg/kg in FP
17050	000104-76-7	2-ethyl-1-hexanol	SML = 30 mg/kg
17160	000097-53-0	Eugenol	SML= 0.1 mg/kg
17170	061788-47-4	Coconut fatty acids	
17200	068308-53-2	Fatty acids of soybean oil	
17230	061790-12-3	Fatty acids of tall oil	
17260	000050-00-0	Formaldehyde	SML = 15 mg/kg
17290	000110-17-8	Fumaric acid	
17530	000050-99-7	Glucose	
18010	000110-94-1	Glutaric acid	
18070	000108-55-4	Glutaric anhydride	
18100	000056-81-5	Glycerol	
18250	000115-28-6	Hexachloroendo-methyl-Enetetrahy-drophthalic acid	SML = ND (DL = 0.01 mg/kg)
18280	00115-27-5	Hexachloroendome-thyl Enetetrahydro-phthalic anhydride	SML = ND (DL = 0.01 mg/kg)
18310	036653-82-4	1-hexadecanol	
18430	00116-15-4	Hexafluoropropylene	SML = ND (DL = 0.01 mg/kg)
18460	000124-09-4	Hexamethylenediamine	SML = 2.4 mg/kg
18640	000822-06-0	Hexamethylene diisocyanate	MQ(T) = 1 mg/kg in FP (expressed as NCO)
18670	000100-97-0	Hexamehtylene tetramine	SML(T) = 15 mg/kg (expressed as formaldehyde)
	00123-31-9	Hydroquinone	See 1,4-dihydroxybenzene
18880	000099-96-7	p-hydroxybenzoic acid	
19000	000115-11-7	Isobutene	
19210	001459-93-4	Dimethyl isophthalate	SML = 0.05 mg/kg
19270	000097-65-4	Itaconic acid	
19460	000050-21-5	Lactic acid	

INTERNATIONAL GENOTOXICOLOGICAL CODEX

Electrodialysis Membranes

COEI-1-MEMELE: 2000

PM/REF N°	Case N°	Name	Restrictions
19470	000143-07-7	Lauric acid	
19480	002146-71-6	Vinyl laurate	
19510	011132-73-3	Lignocellulose	
19540	000110-16-7	Maleic acid	SML(T) 30 mg/kg
19960	00108-31-6	Maleic anhydride	SML(T) = 30 mg/kg (expressed as maleic acid)
	000108-31-6	Melamine	See 2,4,6-triamino-1,3,5-triazine
20020	000079-41-4	Methacrylic acid	
20080	002495-37-6	Benzyl methacrylate	
20110	000097-88-1	Butyl methacrylate	
20140	002998-18-7	sec-butyl methacrylate	
20890	000097-63-2	Ethyl methacrylate	
21010	000097-86-9	Isobutyl methacrylate	
21100	004655-34-9	Isopropyl methacrylate	
21130	000080-62-6	Methyl methacrylate	
21190	000868-77-9	Ethylene glycol monomethacrylate	
21280	002177-70-0	Phenyl methacrylate	
21340	000760-93-0	Propyl methacrylate	
21460	000760-93-0	Methacrylic anhydride	
21490	000126-98-7	Methacrylonitrile	SML = not detectable (DL = 0.020 mg/kg, including analytic tolerance)
21550	000067-56-1	Methanol	
21940	000924-42-5	N-methylolacrylamide	SML = ND (DL = 0.0 mg/kg)
22150	000691-37-2	4-methyl-pentene	SML = 0.02 mg/kg
22350	000544-63-8	Myristic acid	
22390	000840-65-3	2,6-dimethyl naphthalene-dicarboxylate	SML = 0.05 mg/kg
22420	003173-72-6	1,5-naphthalene diisocyanate	MQ(T) 1 mg/kg in FP (expressed as NCO)

INTERNATIONAL CENOLOGICAL CODEX

Electrodialysis Membranes

COEI-1-MEMELE: 2000

PM/REF N°	Case N°	Name	Restrictions
22450	009004-70-0	Nitrocellulose	
22480	000143-08-8	1-nonanol	
22570	000112-96-9	Octadecyl isocyanate	MQ(T) = 1 mg/kg in FP (expressed as NCO)
22600	000111-87-5	1-octanol	
22660	000111-66-0	1-octene	SML = 15 mg/kg
22763	000112-80-1	Oleic acid	
22780	000057-10-3	Palmitic acid	
22840	000115-77-5	Pentaerythritol	
22870	000071-41-0	1-pentanol	
22960	000108-95-2	Phenol	
23050	000108-45-2	1,3-phenylenediamine	MQ = 1 mg/kg in FP
	000075-44-5	Phosgene	See Carbonyl chloride
23170	007664-38-2	Phosphoric acid	
		Phthalic acid	See Terephthalic acid
23200	000088-99-3	o-phthalic acid	
23230	000131-17-9	Diallyl phthalate	SML = ND (DL = 0.01 mg/kg)
23380	000085-44-9	Phthalic anhydride	
23470	000080-56-8	alpha-pinene	
23500	000127-91-3	beta-pinene	
23590	025322-68-3	Polyethylene glycol	
23651	025322-69-4	Polypropylene glycol	
23740	000057-55-6	1,2-propanediol	
23800	000071-23-8	1-propanol	
23830	000067-63-0	2-propanol	
23860	000123-38-6	Propionaldehyde	
23890	000079-09-4	Propionic acid	

INTERNATIONAL GENOLOGICAL CODEX**Electrodialysis Membranes**

COEI-1-MEMELE: 2000

PM/REF N°	Case N°	Name	Restrictions
23950	000123-62-6	Propionic anhydride	
23980	000115-07-1	Propylene	
24010	000075-56-9	Propylene oxide	MQ = 1 mg/kg in FP
	000120-80-9	Pyrocatechol	See 1,2-dihydroxybenzene
24057	000089-32-7	Pyromellitic anhydride	SML = 0.05 mg/kg (expressed as pyromellitic acid)
24070	073138-82-6	Resin acids	
	000108-46-3	Resorcinol	See 1,2-dihydroxybenzene
24100	008050-09-7	Rosin	
24130	008050-09-7	Rosin gum	See Rosin
24160	008052-10-6	Tall oil resin	
24190	009014-63-5	Wood resin	
24250	009006-04-6	Natural rubber	
24270	000069-72-7	Salicylic acid	
24280	000111-20-6	Sebacic acid	
24430	002561-88-8	Sebacic anhydride	
24475	001313-82-2	Sodium sulfide	
24490	000050-70-4	Sorbitol	
24520	008001-22-7	Soybean oil	
24540	009005-25-8	Food starch	
24550	000057-11-4	Stearic acid	
24610	000100-42-5	Styrene	
24820	000110-15-6	Succinic acid	
24850	000108-30-5	Succinic anhydride	
24880	000057-50-1	Saccharose	
24887	006362-79-4	5-sulfoisophthalic acid, monosodium salt	SML = 5 mg/kg

INTERNATIONAL TECHNOLOGICAL CODEX

Electrodialysis Membranes

COEI-1-MEMELE: 2000

PM/REF N°	Case N°	Name	Restrictions
24888	003965-55-7	5-dimethylsulfo- isophthalate, monosodium salt	SML = 0.05 mg/kg
24910	000100-21-0	Terephthalic acid	SML = 7.5 mg/kg
24940	000100-20-9	Terephthalic acid dichloride	SML(T) = 7.5 mg/kg (expressed as terephthalic acid)
24970	000120-61-6	Dimethyl terephthalatae	
25090	000112-60-7	Tetraethylene glycol	
25120	000116-14-3	Tetrafluoroethylene	SML = 0.05 mg/kg
25150	000109-99-9	Tetrahydrofuran	SML = 0.6 mg/kg
25180	000102-60-3	N,N,N',N'-tetrakis(2-hydroxypropyl)-ethylene-diamine	
25210	000584-84-9	Toluene-2,4-diisocyanate	MQ(T) = 1 mg/kg in FP (expressed as nCO)
25240	000091-08-7	Toluene-2,6-diisocyanate	MQ(T) = 1 mg/kg in FP (expressed as nCO)
25270	026747-90-0	Toluene-2,4-diisocyanate, dimer	MQ(T) = 1 mg/kg in FP (expressed as nCO)
25360		2,3-epoxy trialkyl(C ₅ -C ₁₅) acetate	SML = 6 mg/kg
25420	000108-78-1	2,4,6-triamino-1,3,5-triazine	SML = 30 mg/kg
25510	000112-27-6	Triethylene glycol	
25600	000077-99-6	1,1,1-trimethylolpropane	SML = 6 mg/kg
25910	024800-44-0	Tripropylene glycol	
25960	000057-13-6	Urea	
26050	000075-01-4	Vinyl chloride	See Council Directive 78/142/EEC
26110	000075-35-4	Vinylidene chloride	MQ = 5 mg/kg in FP or SML = ND (DL = 0.05 mg/kg)
26140	000075-38-7	Vinylidene fluoride	SML = 5 mg/kg

A number of abbreviations or notations are given in Column 4. Their meaning is listed below :

DL = Detection limit of the analytical method.

FP = Finished material or product

NCO = isocyanate group

ND = not detectable.

For the purposes of the present directive, the expression « not detectable » means that the substance will not be detected by the approved analytical method, which is sensitive enough to detect it at the specified detection limit. If, however, a method of this kind does not currently exist, an analytical technique possessing performance characteristics suited to the specified limit may be used, while awaiting the development of an approved method.

MQ = maximum permitted quantity of the « residual » substance in the material or article.

MQ(T) = maximum permitted quantity of residual substance in the material or article, expressed as the total group or of the indicated substances(s).

For the purposes of this directive, « MQ(T) » means that the maximum permitted quantity of the « residual » substance in the material or article should be determined using an analytical method approved for the specified limit. If, however, a method of this kind does not currently exist, an analytical technique possessing performance characteristics suitable for determining the specified limit may be used, while awaiting the development of an approved method.

SML = specific migration limit in the food product or the simulated food, unless otherwise specified.

For the purposes of this directive, « SML » means that the specific migration of the substance should be determined using an analytical method approved for the specified limit. If, however, a method of this kind does not currently exist, an analytical technique possessing performance characteristics suitable for determining the specified limit may be used, while awaiting the development of an approved method.

SML(T) = specific migration limit in the food product or simulated food, expressed as the total

of the group or of the indicated substance(s).

For the purposes of this directive, « SML(T) » means that the specific migration of the substance should be determined using an analytical method approved for the specified limit. If, however, a method of this kind does not currently exist, an analytical technique possessing performance characteristics suitable for determining the specified limit may be used, while awaiting the development of an approved method.

Annex 2

List of substances used in the manufacture of adsorbant ion-exchange resins used to condition foodstuffs. (Resolution AP (97)1 EC)

List 1

Substances assessed by an international organization

NAME	PM/REF	CASE	RESTRICTIONS
Monomers and other Starting substances			
n-butyl acrylate	10780	00141-32-2	-
Ethyl acrylate	11470	00140-88-5	-
Methyl acrylate	11710	00096-33-3	-
Acrylonitrile	12100	00107-13-1	SML = ND (DL = 0.02 mg/kg) SML = 15 mg/kg
Formaldehyde	17260	00050-00-0	-
Methyl methacrylate	21130	00080-62-6	-
Methanol	21550	00067-56-1	-
Styrene	24610	00100-42-5	-
Chemical Modifiers			
Carbonic acid, salts	42500	-	-
Hydrochloric acid	72640	07664-38-2	-
Silicic acid, salts	85980	-	-
Sulfuric acid	91920	07664-93-9	-
Acetic anhydride	10150	00108-24-7	-
tert-butyl-4-hydroxyanisole (BHA)	40720	25013-16-5	SML=30 mg/kg
Diethylene triamine	15790	00111-40-0	SML= 5 mg/kg
Dimethylamine	49225	00124-40-3	SML=0.06 mg/kg
2-(dimethylamino)ethanol	49235	00108-01-0	SML=18 mg/kg
Formaldehyde	54880	00050-00-0	SML=15 mg/kg
Hexamethylenediamine	18460	00124-09-4	SML=2.4 mg/kg
Potassium hydroxide	81600	01310-58-3	-
Sodium hydroxide	86720	01310-73-2	-
Sodium nitrite	86920	07632-00-0	SML=0.6 mg/kg
Ethylene oxide	17020	00075-21-8	MQ=1 mg/kg in FP
2-propanol	81882	00067-63-0	-
Polymerization Additives			
Alkylsulfonic acids (C ₈ -C ₂₂)	34230	-	SML=6 mg/kg
Linear, primary alkylsulfuric acids (C ₈ -C ₂₂) having an even number of carbon atoms	34281	-	-
Formic acid	55040	00064-18-6	-
Carboxymethylcellulose	42640	09000-11-7	-
Stannic chloride(IV)	93420	07646-78-8	-
Methylene chloride	66620	00075-09-2	SML=0.05 mg/kg
1,4-dihydroxybenzene	48620	00123-31-9	SML=0.6 mg/kg
Gelatin	55440	09000-70-8	-
Ammonium hydroxide	35600	01336-21-6	-
Magnesium hydroxide	64640	01309-42-8	-
Hydroxyethylcellulose	60560	09004-62-0	-
Hydroxyethylmethylcellulose	60880	09032-42-4	-
Methanol	65960	00067-56-1	-
Methylcarboxymethylcellulose	66200	37206-01-2	-

INTERNATIONAL GENOTOXICOLOGICAL CODEX

Electrodialysis Membranes

COEI-1-MEMELE: 2000

Methyl isobutyl ketone
Toluene

66725 00108-10-1
93540 00108-88-3

SML=5 mg/kg
SML=1.2 mg/kg

Annex 3

Substances that may be used provisionally to manufacture ion-exchange resins.

List 2

1. Substances not fully evaluated by an international organization

NAME	PM/REF	CASE	RESTRICTIONS
Monomers and other starting substances			
Ethylene glycol dimethacrylate	20440	00097-90-5	-
Divinylbenzene	16690	01321-74-0	-
Diallyl ether of 1,1,1-trimethylolpropane	25645	00682-09-7	-
2,3-epoxypropyl methacrylate	20590	00106-91-2	-
2-methyl-1,3-butadiene	21640	00078-79-5	-
1,7-octadiene	22585	03710-30-3	-
1,1,1-trimethylolpropane trimethacrylate	25840	03290-92-4	-
Chemical Modifiers			
N,N-dimethyl-1,3-diaminopropane	49380	00109-55-7	-
Triethylamine	95270	00121-44-8	-
Triethylene tetramine	25520	00112-24-3	-
Polymerization Additives			
Polyvinyl alcohols	81280	09002-89-5	-
4-tert-butylcatechol	40640	00098-29-3	-
Diisobutyl ketone	49050	00108-83-8	-
Sodium hypochlorite	62110	07681-52-9	-
Isobutanol	62270	00078-83-1	-
4-methoxyphenol	66030	00150-76-5	-
Methylene bis(sodium naphthalenesulfonate)	66600	26545-58-4	-
2-methyl-2-pentanol	66860	00108-11-2	-
Dibenzoylperoxide	46440	00094-36-0	-
Partially hydrolyzed vinyl polyacetate	81260	-	-

2. Substances not evaluated by an international organization

NAME	PM/REF	CASE	RESTRICTIONS
Monomers and other starting substances			
Dimethoxymethane	-	00109-87-5	-
Diethylene glycol divinyl ether	-	00764-99-8	-
Ethyl vinyl benzene	-	28106-30-1	-
1,2,4-trivinyl cyclohexane	-	02855-27-8	-
Chemical Modifiers			
Chlorosulfonic acid	-	07790-94-5	-
Monochloroacetic acid	-	00079-11-8	-
Phosphoric acid	-	13598-36-2	-
Bromine	-	07726-95-6	-
2-chloroethanol	-	00107-07-3	-
Methyl chloride	-	00074-87-3	-
1,2-dichloroethane	-	00107-07-3	-
1,2-dichloropropane	-	00078-87-5	-

INTERNATIONAL CENOLOGICAL CODEX

Electrodialysis Memranes

COEI-1-MEMELE: 2000

3-(dimethylamino)propane - 03179-63-3 -

NAME	PM/REF	CASE	RESTRICTIONS
Monomers and other starting substances			
Methylic chloromethyl ether	-	00107-30-2	-
Nitrobenzene	-	00098-95-3	-
Potassium nitrite	-	07758-09-0	-
Phthalimide	-	0085-41-6	-
Sulfur trioxide	-	07446-11-9	-
Trimethylamine	-	00075-50-3	-
Polymerization additives			
Lignosulfonic acid	63940	08062-15-5	-
Peracetic acid	-	00079-21-0	-
Polyacrylic acid	76460	09003-01-4	-
Poly(styrenesulfonic) acid	-	09080-79-9	-
Acrylamide/acrylic acid copolymer	-	09003-06-9	-
Ethoxylated, propoxylated tert-alkylamines (C ₁₂ -C ₁₄)	-	68603-58-7	-
Maleic anhydride-styrene copolymer, ammonium salt	-	26022-09-3	-
Attapulgite	-	12174-11-7	-
Azobisisobutyronitrile	-	00078-67-1	-
1,1-bis(tert-butylperoxy)-3,3,5-trimethylcyclohexane	-	06731-36-8	-
n-Dodecyl mercaptan	-	25103-58-6	-
Poly(ethylene/propylene)glycol monobutyl ester	-	09038-95-3	-
Polyethylene glycol octylphenyl ether	78560	09002-93-1	-
Poly(ethylene-propylene/glycol ether with 1,1,1-trimethylol-propane	-	52624-57-4	-
tert-hexadecyl mercaptan	-	25360-09-2	-
Cumyl hydroperoxide	-	00080-15-9	-
Isododecane	62405	31807-55-3	-
Isooctane	-	26635-64-3	-
Mono- and dialkyl (C ₁₀ -C ₁₈) Sulfonamides	-	-	-
Silver nitrate	-	07761-88-8	-
n-Octane	-	00111-65-9	-
tert-Butyl peracetate	-	00107-71-1	-
tert-Butyl perbenzoate	-	00614-45-9	-
bis(4-tert-butylcyclohexyl) percarbonate tert-	-	15520-11-3	-
Butyl per(2-ethyl-hexanoate)	-	03006-82-6	-
tert-Butyl peroctanoate	-	13467-82-8	-
Dilauroyl peroxide	-	00105-74-8	-
Poly(diallyldimethylammonium chloride)	-	26062-79-3	-
Polyvinylpyrrolidone	81500	09003-39-8	-

BIPOLAR ELECTRODIALYSIS MEMBRANES

OIV-OENO 411-2011

1. Object, origin and scope of application

A bipolar membrane is a thin, dense, insoluble wall composed of a polymer material functionalized by ionic groups. A bipolar membrane has an anionic face and a cationic face; it is equivalent to combining a cationic membrane and an anionic membrane into a single membrane. Cationic and anionic membranes are defined in the International Oenological Codex (Electrodialysis membranes, Oeno 29/2000)

The membrane pair used in the bipolar electro dialysis acidification technique consists of a bipolar membrane and a cationic membrane. This arrangement, in the stack of an electro dialyser, only permits the extraction of cations..

- The cationic membrane allows the preferred flow of cations, in particular potassium.
- The function of the bipolar membrane is to maintain the acido-basic ionic balance of the system, following the extraction of a percentage of the potassium from the must or wine.

2. Composition of the membranes

2.1 Composition of the cation membrane

Cation membranes used in the acidification technique by bipolar membrane electro dialysis must comply with the prescriptions stated in the monograph concerning electro dialysis membranes (Oeno Resolution 29/2000) in the International Oenological Codex.

2.2 Composition of the bipolar membrane

The bipolar membrane suitable for use is a styrene-divinylbenzene copolymer, whose cationic face and anionic face comply with the composition of cationic and anionic membranes described in the International Oenological Codex (Electrodialysis membranes, Oeno 29/2000)

- 2.3 They should be manufactured in accordance with the good manufacturing practices for the substances listed in:

2.3.1 *Annex 1* of the monograph on electro dialysis membranes (Resolution Oeno 29/2000) pertaining to materials placed in contact with foodstuffs.

2.3.2 *Annexes 2 and 3* of the monograph on electro dialysis membranes (Resolution Oeno 29/2000) pertaining to ion-exchange resins used in processing foodstuffs.

2.4 They should be prepared to serve their intended function, in accordance with the instructions provided by the manufacturer or supplier.

2.5 They should not release any substance in a quantity which endangers human health or which degrades the taste or odour of foodstuffs.

2.6 In use, there should be no interaction between the constituents of the membrane and those of the must or wine likely to form new compounds in the treated product that could have toxicological consequences.

3. Limits on use

The diffusion of small molecules such as ethanol should be limited and should not result in a reduction in the alcoholic strength greater than 0.1% by volume.

4. Conditions of use

The membranes shall be stored and cleaned using accepted techniques and substances whose use is authorised for the preparation of foodstuffs.

ENZYMATIC PREPARATIONS

AG 4/82-OEN;
AG 6/84-OEN;
OENO 6/95;
OENO 14/2003;
OIV/OENO 365/2009;
OIV-OENO 485-2012

The prescriptions described below concern all enzymatic preparations susceptible of being used during various operations that can be applied to grapes and their derivatives.

The prescriptions are based on the recommendations from the "General Specifications and Considerations for Enzymes used in Food Processing" drafted by the "Joint FAO/WHO Expert Committee on Food Additives (JECFA), 67th Session, Rome 20 -29 June 2006" published in 2006 in the *FAO JECFA monographs*.

1. GENERAL CONSIDERATONS

Enzymatic preparations can be made from any safe biological sources. When looking for synergies between various enzymatic activities including pectinase, cellulase and hemicellulase, mixtures of preparations made from different strains can be carried out. These preparations can contain one or more active compounds, in addition to supports, diluents, preservatives, antioxidants and other substances compatible with the good manufacturing practices and in accordance with local regulations. In certain cases, preparations can contain cells or cell fragments. Furthermore they can be in either liquid or solid form. The active substances can also be immobilised on a support admitted for food use.

2. LABELLING

The labelling of enzymatic preparations must at least specify the enzyme name according to IUBMB rules (ex. polygalacturonase), the activity (in units by g or mL), the batch number storage condition for maintaining stability and the expiry date. Enzymatic preparations with

multiple technological activities (cf. 4.1) should bear the name of each enzyme on which the preparation is standardized.

If there is available space, it is desirable that the label has the additional information: recommended dose and implementation conditions, the nature of additives and carriers used, the nature of enzymatic activities. If there is not enough space, this information shall be indicated on the technical data sheet of the preparation.

The indication that enzymatic preparations were obtained by genetically modified organisms must be mentioned. If it is not mentioned in the labelling, the fact that genetic engineering was used to improve the microorganism that produces the enzyme has to be mentioned in related documentation.

3. ADMITTED ENZYMATIC PREPARATIONS

All enzymatic preparations with activities presenting a technological interest duly proven in practice and meeting the conditions and criteria mentioned above, are accepted for the treatment of grapes and their by-products.

Enzymatic preparations used must not contain any substance, microorganism, nor enzymatic activity that:

- is harmful to health,
- is harmful to the quality of the products manufactured, particularly concerning the colour, the aroma and the taste of the wines,
- can lead to the formation of undesirable products,
- or that will give rise or facilitate fraud.

4. ENZYMATIC ACTIVITIES

4.1 General considerations

[Enzymatic preparations contain many enzymatic activities. Other than the main enzymatic activities, (activities for which, respectively, the enzymatic preparation has been standardised) whose technological interest has been duly proven, secondary enzymatic activities are only tolerated if they are set within the technological constraint limits for manufacturing of enzymatic preparations.]

Generally speaking, the secondary activities present in a given preparation must not become the main reason to use the said

preparation unless this preparation is declared as multiple technological effects. Referring to the International Code of Oenological

Practices, Oeno 11/04 – 18/04 and 3/85, on a technological level, a distinction is made between the following types of preparations

- Maceration preparations: facilitate extraction of compounds such as colour, tannins,...
- Clarification / filtration preparations: facilitate clarification and filtration of musts and wine
- Aroma enhancers: reinforces and/or modifies aromatic profile of musts and wine
- Stabilisation preparations: facilitates extraction of macromolecules or other substances with a stabilising effect on wine (yeast mannans).

When an enzymatic preparation generates multiple technological effects, duly noted in a practice, (ex. Clarification and aroma enhancer enzymes), whether they are the result of a main and/or secondary activity, they must be declared as such on the label. Different enzymatic activities responsible for these effects must be measured and indicated in the technical preparation data sheet.

4.2 Activity measurement

The enzymatic activities presented are measured under the conditions corresponding to their biochemical characteristics. (pH, temperature) and if possible, the closest to activities encountered in the practice (grape juice, must or wine). The methods implemented must correspond to state of the art in analytical terms and, if possible, be validated in accordance with appropriate international standards (for example: ISO 78-2; ISO 5725).

Results are expressed in nanokatal/g or nanokatal/mL or in viscosity units in the case of enzymes with endo-type of activities. (nkat = 1 nmole of transformed substrate or product formed per second by g or mL of the preparation). Results should be given with reference to the method used.

When the sought out technological effect results from the action of different enzymes within the same preparation, it is necessary to measure each enzymatic activity. Each of these activities will require special Codex monograph, with the details of the analytical method.

5. SOURCES OF ENZYMES AND FERMENTATION

ENVIRONMENT

The sources of enzymes must be non-pathogenic, non-toxic and genetically stable, and the fermentation broth should not leave harmful residues in enzymatic preparations. In the case of microorganisms, a safety study must be conducted in order to ensure that enzymatic preparation produced by a microorganism species (*e.g. Aspergillus niger*) does not present any health risk. This study can be based on principles brought forth on food enzyme guidelines published by the European Food Safety Authority (EFSA), or other equivalent organisations.

The techniques implemented must be compatible with good manufacturing practices and the prescriptions of the International Oenological Codex if yeast and/or lactic bacteria are used.

6. CARRIERS, DILUENTS, PRESERVATIVES AND OTHER ADDITIVES

Substances used as carriers , diluents, preservatives or other additives must not, with a "carry over" effect, disseminate compounds in the grapes and derivative products, which are not compatible with regulations in force in different countries. Moreover, these compounds must not have a negative effect on the organoleptic properties of wine. In the case of immobilised enzymes, the carriers used must comply to standards on material in contact with foodstuffs. For this type of preparation, the content of compounds of the carriers used, susceptible to enter the musts and wine, should be determined and indicated on the label of the enzymatic preparation.

Preservatives such as KCl are added in the liquid enzyme concentrate during manufacturing. These substances prevent the development of micro-organisms during the different formulation operations of products. These substances can be found not only in liquid preparations but also in solid preparations. Given the inevitable "carry over" effect, only preservatives which are compatible to regulations in force in the different countries are authorised.

These substances must be clearly identified and indicated on the label or on the technical data sheet of the commercial product.

7. HYGIENE AND MAXIMAL LEVEL OF CONTAMINANTS

Enzymatic preparations must be produced in accordance with good manufacturing practices:

7.1 Lead

Proceed with the determination according to the method described in chapter II of the International Oenological Codex.
Content less than 5 mg/kg.

7.2 Mercury

Proceed with the determination according to the method described in chapter II of the International Oenological Codex.
Content less than 0.5 mg/kg.

7.3 Arsenic

Proceed with the determination according to the method described in chapter II of the International Oenological Codex.
Content less than 3 mg/kg.

7.4 Cadmium

Proceed with the determination according to the method described in chapter II of the International Oenological Codex.
Content less than 0.5 mg/kg.

7.5 *Salmonella* sp

Proceed with counting according to the method described in chapter II of the International Oenological Codex.
Absence checked on a 25 g sample.

7.6 Total coliforms

Proceed with counting according to the method described in chapter II of the International Oenological Codex.
Content less than 30/per gram of preparation.

7.7 *Escherichia coli*

Proceed with counting according to the method described in chapter II of the International Oenological Codex.
Absence checked on a 25 g sample.

7.8 ANTIMICROBIAL ACTIVITY

Non-detectable

7.9 SPECIFIC MYCOTOXINS OF DIFFERENT PRODUCTION STRAINS

Non-detectable

8. TECHNICAL DATA SHEET TO BE SUPPLIED BY MANUFACTURER

Each type of enzymatic preparation must be defined using a technical data sheet.

It must contain at least the following information:

- Name of enzyme and biological origin (e.g. pectolytic enzymes of *Aspergillus niger* or pectolytic enzyme of *A. oryzae* expressed as *A. niger*),
- Declared activity (in nKat/g or nKat/ml of preparation)
- Fields and application mode (technological effects and useful details for the implementation of the preparation) ,
- Stability of the preparation and expiration date period based on production date guaranteeing the maintaining of activity, under the given storage conditions (temperature),
- Types of reactions catalysed by the main enzymatic activities,
- Main enzymatic activities with IUB number (for example Tannase 3.1.1.20),
- Secondary enzymatic activities with, if possible, the IUB number
- Types of carriers, diluents, preservatives and additives used and their respective contents,
- If deemed useful, further information can be added to this technical data sheet.

**DETERMINATION OF ENDO- α (1,5) ARABINANASE ACTIVITY IN
PECTOLYTIC ENZYME PREPARATIONS**

(EC 3.2.1.99 – CAS N°75432-96-1)

OIV-OENO 412-2012

General specifications

These enzymes are usually present among other activities, within a complex enzymatic preparation. Unless otherwise stipulated, the specifications must comply with the resolution OENO 365-2009 concerning the general specifications for enzymatic preparations included in the International Oenological Codex.

1. Origin

Reference is made to paragraph 5 "Source of enzyme and fermentation environment" of the general monograph on Enzymatic preparation

The enzymatic preparations containing these activities are produced by directed fermentation of microorganisms such as *Aspergillus niger*, *Aspergillus Tubigenis*, *Aspergillus Awamori* *Trichoderma reesei*, *Penicillium funiculosum* or Arabinanases belong to the family glycohydrolases.

2. Scope / Applications

Reference is made to the International Code of Oenological Practices, OENO 11/04; 12/04; 13/04; 14/04 and 15/04.

Arabinanases are useful for the maceration of the grapes, the clarification of musts and wines, the filterability of musts and wines since they are facilitating the action of other enzyme activities hydrolysing the constituents of the cell wall of grape.

3. Principle

The substrate employed is Azurine-crosslinked debranched arabinan (AZCL-Arabinan). Highly purified arabinan from sugar-beet pulp is treated with α -L-arabinofuranosidase to remove 1,3- and 1,2- α -linked arabinofuranosyl residues, leaving linear 1,5- α -arabinan. This

polysaccharide still contains a small percentage of galacturonic acid, galactose and rhamnose (6, 4 and 2 % respectively), but is resistant to attack by polygalacturonase and endo-1,4- β -D-galactanase. The polysaccharide is then dyed and crosslinked. Treatment of this substrate with a large excess of α -L-arabinofuranosidase results in a limited release of arabinose but no release of dye labelled fragments.

AZCL-Arabinan is a highly sensitive and very specific substrate for the assay of endo arabinanase, when you measure the supernatant after the reaction at 590 nm.

4. Apparatus

- 4.1 Glass test tubes (15 ml)
- 4.2 Water bath set 40 °C
- 4.3 Vortex tube mixer
- 4.4 Qualitative Filter circle, retained particle diameter : 11 μ m (in liquid)
- 4.5 1 cm light path cuvettes
- 4.6 Spectrophotometer set 590 nm
- 4.7 Chronometer
- 4.8 Pipet (500 μ l, 10 ml)
- 4.9 pH meter
- 4.10 15 ml glass test tubes
- 4.11 Metal rack for 15 ml test tubes
- 4.12 Funnel
- 4.13 100 ml graduated flask

5. Reagents and products:

- 5.1 Arabinazyme Tablets (Megazyme, batch 60701 as an example)
- 5.2 Trizma base (CAS no. 77-86-1)
- 5.3 Glacial acetic acid (CAS No. 64-19-7)
- 5.4 Sodium hydroxid solution (CAS No. 1310-73-2)

6. Solutions

- 6.1 Dilution Buffer

(Sodium Acetat buffer, 50 mM, pH 4.0)

Glacial acetic acid is added to 900 ml of distilled water. This solution is adjusted to pH 4,0 by the addition of 1 M sodium hydroxide solution.

The volume was adjusted to 1 L with distilled water.

6.2 2 % Trizma Base Solution
Dilute 2 g Trizma Base in 100 ml distilled water.

7. Preparation of the sample

7.1 Enzyme dilution

For most commercial pectinase enzyme preparations, a dilution of 500-fold is required. Place 200 mg of commercial preparation in a 100 ml graduated flask, make up with dilution buffer (6.1), and stir in order to obtain a homogeneous mixture.

8. Procedure

8.1 Enzymatic reaction

The test tubes are prepared at least in duplicate.

500 µl of diluted enzyme in dilution buffer (7.1) are pre-equilibrated to 40 °C for 5 min.

The reaction is initiated by the addition of an Arabinazyme tablet. Start the chronometer.

The tablet hydrates rapidly. The suspension should not be stirred.

After exactly 10 min at 40 °C the reaction is terminated by the addition of 10 ml Trizma Base solution (6.2) and stir.

After about 5 min standing at room temperature, the slurry is stirred again and filtered through a qualitative filter circle.

The absorbance of the reactions solutions are then measures at 590 nm against the reaction blank

8.2 Reaction blank

A reaction blank is prepared by adding 10 ml Trizma base solution (6.2) to 500 µl enzyme solution and stir before the addition of the Arabinazyme tablet.

9. Calculations

Endo-Arabinanase activity being assayed is determined by reference to the calibration curve of the test kit (i.e. Lot.No. 60701)

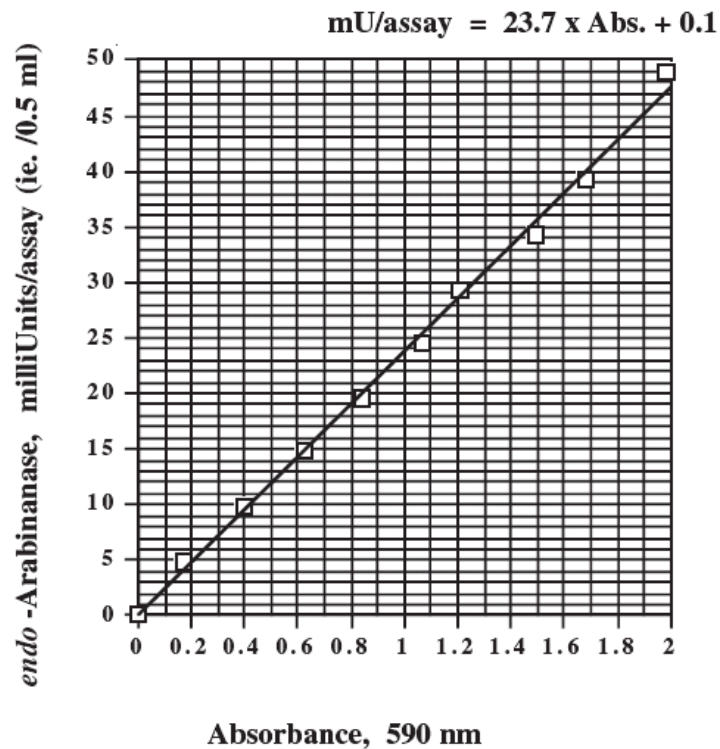

$$Y = MX + C * 2 * F_v / 1000$$

[U/g or ml]

Where:

- Y endo-arabinase activity (in milliUnits/assay)
- M slope of the calibration graph
- X absorbance of the reaction at 590 nm (minus the reaction blank, or read against the reaction blank)
- C intersection on the Y-axis (intercept point)
- 2 conversion from 0,5 ml enzyme dilution to 1 ml in the test
- F_v Dilution factor of the original enzyme preparation (i.e. 500-fold)
- 1000 conversion from milliUnits to Units

10. References

<http://secure.megazyme.com/downloads/en/data/T-ARZ200.pdf>
 Dietrich H., Will F. (1998); Vom Phänomen der Trübung;
 Getränkeindustrie; 2; S. 80 – 88.

Determination of endo-1,4- β -xylanase activity in enzymatic preparations
(EC 3.2.1.8; CAS no.: 9025-57-4)
OIV-OENO 573-2018

General specifications

Hemicellulases are generally present in enzymatic preparations among other activities within an enzymatic complex. Unless otherwise stated, the specifications must be compliant with Resolution OENO 365-2009 on the general specifications of enzymatic preparations that appear in the *International Oenological Codex*.

1. Origin and application

Hemicellulases catalyse the degradation of hemicelluloses. The hemicelluloses of the cell walls of grape berries are principally composed of xyloglucans and arabinoxylans; these two polysaccharides constitute almost 90% of grape hemicelluloses.

The hemicellulase activity of enzymatic preparations is evaluated by measuring the 1,4- β -xylanase activity. Enzymatic preparations containing hemicellulase activities are used during grape maceration, and in the clarification and improvement of the filterability of musts and wines.

Enzymatic preparations containing these activities are derived from the managed fermentation of, for example, *Aspergillus* sp. or *Trichoderma* sp., or mixtures of enzymes thus obtained.

2. Scope of application

The method of determination was developed using commercial xylanase. The conditions and the method were developed for use with commercial enzymatic preparations such as those available on the market of oenological products.

3. Principle

Xylanases hydrolyse xylan chains and thus liberate the constitutive monosaccharides at the reducing ends. The measurement of the xylanase activity is estimated by measuring the reducing monosaccharides (xylose) liberated during the incubation period,

according to the Nelson method (1944). In the alkaline environment the pseudo-aldehyde groups of the sugars reduce the cupric Cu^{2+} ions. These ions react with the arsenomolybdate reagent, giving it a blue colouring, for which the absorbance – measured at 520 nm – varies in a linear manner with the monosaccharide concentration (between 0 and 400 $\mu\text{g}/\text{mL}$).

4. Apparatus

- 4.1 Magnetic-stirrer hotplate
- 4.2 Water bath at 40 °C
- 4.3 Water bath at 100 °C
- 4.4 100-mL Cylindrical flask
- 4.5 Centrifuge compatible with 15-mL glass tubes
- 4.6 Stopwatch
- 4.7 100-mL Calibrated flasks
 - 4.7.1 500-mL Calibrated flask
- 4.8 200- μL Precision syringe
 - 4.8.1 1-mL Precision syringe
- 4.9 10-mL Straight pipette calibrated with graduations at 0.1-mL intervals
- 4.10 Spectrophotometer
- 4.11 15-mL Glass tubes
- 4.12 Vortex-type stirrer
- 4.13 500-mL Brown-glass flask
- 4.14 Chamber at 4 °C
- 4.15 Oven at 37 °C
- 4.16 Cotton wool
- 4.17 Kraft paper
- 4.18 pH Meter
- 4.19 Metal tray for 15-mL tubes
- 4.20 Single-use spectrophotometer cuvettes with a 1-cm optical path, for measurement in the visible spectrum

5. Products

- 5.1 Sodium acetate (pure CH_3COONa at 99% - PM = 82 g/mol
- 5.2 Acetic acid (pure CH_3COOH at 96% - PM = 60 g/mol, density = 1.058)
- 5.3 Xylan (beechwood) P-XYLNBE-10G, Lot No. 171004a, Megazyme
- 5.4 Sodium sulphate anhydrous (pure Na_2SO_4 at 99.5% - PM = 142 g/mol)

- 5.5 Sodium carbonate anhydrous (pure Na_2CO_3 at 99,5% - PM = 105.99 g/mol)
- 5.6 Potassium sodium tartrate (pure $\text{KNaC}_4\text{H}_4\text{O}_6 \cdot 4\text{H}_2\text{O}$ at 99% - PM = 282.2 g/mol)
- 5.7 Sodium hydrogen carbonate anhydrous (pure NaHCO_3 at 98% - PM = 84.01 g/mol)
- 5.8 Copper sulphate pentahydrate (pure $\text{CuSO}_4 \cdot 5\text{H}_2\text{O}$ at 99% - PM = 249.68 g/mol)
- 5.9 Concentrated sulphuric acid (pure H_2SO_4 at 98%)
- 5.10 Ammonium heptamolybdate (pure $(\text{NH}_4)_6\text{Mo}_7\text{O}_{24} \cdot 4\text{H}_2\text{O}$ at 99% - PM = 1235.86 g/mol)
- 5.11 Sodium hydrogen arsenate (pure $\text{Na}_2\text{HAsO}_4 \cdot 7\text{H}_2\text{O}$ at 98.5% - PM = 312.02 g/mol)
- 5.12 D-xylose (pure $\text{C}_5\text{H}_{10}\text{O}_5$ at 99% - PM = 150 g/mol)
- 5.13 Distilled water
- 5.14 Commercial enzymatic preparation for analysis

6. Solutions

6.1 Reagents for the oxidising solution

These reagents should be prepared first, considering the 24-hour time limit for solution D.

6.1.1 Solution A

Successively place in a 100-mL cylindrical flask (4.4):

- 20 g sodium sulphate anhydrous (5.4),
- 2.5 g sodium carbonate anhydrous (5.5),
- 2.5 g potassium sodium tartrate (5.6),
- 2 g sodium hydrogen carbonate anhydrous (5.7).

Dissolve in 80-mL distilled water (5.13). Heat and mix (4.1) until dissolution and transfer to a 100-mL flask (4.7). Make up to the calibration mark with distilled water (5.13).

Store at 37 °C (4.15); if a deposit forms, filter through fluted filter.

6.1.2 Solution B

Dissolve 15 g copper sulphate pentahydrate (5.8) in 100 mL distilled water (5.13) and add a drop of concentrated sulphuric acid (5.9).

6.1.3 Solution C

This solution is prepared just before use in order to have good proportionality between the colour density and quantity of glucose by mixing 1 mL solution B (6.1.2) with 24 mL solution A (6.1.1).

6.1.4 Solution D

In a 500-mL calibrated flask (4.7.1), dissolve 25 g ammonium heptamolybdate (5.10) in 400 mL water (5.13). Add 25 mL concentrated sulphuric acid (5.9) (cooled under a flow of cold water).

In a 100-mL cylindrical flask (4.4), dissolve 3 g sodium hydrogen arsenate (5.11) in 25 mL water (5.13) and quantitatively transfer to a 500-mL calibrated flask (4.7.1) containing ammonium molybdate (5.10).

Make up to the mark with water (5.13) to obtain a final volume of 500 mL.

Place at 37 °C (4.15) for 24 hours then store at 4 °C (4.14) in a 500-mL brown-glass flask (4.13).

6.2 Sodium acetate buffer (pH 4.2, 100 mmol/L)

It is made up of solutions A and B.

6.2.1 Solution A (0.1 M sodium acetate): dissolve 0.5 g sodium acetate (5.1) in 60 mL distilled water (5.13).

6.2.2 Solution B (0.1 M acetic acid): dilute 1 mL acetic acid (5.2) with 175 mL distilled water (5.13)

6.2.3 Preparation of sodium acetate buffer: mix 23.9 mL solution A (6.2.1) + 76.1 mL solution B (6.2.2).

Verify the pH of the buffer using a pH meter (4.18).

The solution must be stored at 4 °C (4.14).

6.3 2% Oat-spelt xylan solution (p/v)

In a 100-mL calibrated flask (4.7), dissolve 1 g oat-spelt xylan (5.3) in 100 mL sodium acetate buffer (6.2).

6.4 Xylose stock solution at 400 μ g/mL

Dissolve 0.040 g D-xylose (5.12) in 100 mL distilled water (5.13).

7. Preparation of xylose calibration range

Prepare the calibration range (from 0 to 400 $\mu\text{g}/\text{mL}$) based on the xylose stock solution (6.4) as presented in Table 1.

Table 1: Xylose calibration range

Xylose ($\mu\text{g}/\text{mL}$)	0	50	100	150	200	250	300	400
Xylose ($\mu\text{mol}/\text{mL}$)	0	0.23	0.46	0.69	0.92	1.15	1.38	1.89
Vol. stock solution (μL) (6.4.)	0	125	250	375	500	625	750	1000
Vol. distilled water (μL) (5.13)	1000	875	750	625	500	375	250	0

8. Sample preparation

It is important to mix the enzymatic preparation before sampling, by inverting the container, for example. The enzymatic solution and the blanks should be prepared just before use.

8.1 Enzymatic solution 2 g/L

Place 200 mg of enzymatic preparation (5.14) in a 100-mL calibrated flask (4.7), make up to the mark with distilled water (5.13) and stir in order to obtain a homogenous mixture.

8.2 Heat-denatured blank

Place 10 mL enzymatic solution at 2 g/L (8.1) in a 15-mL tube (4.11) stoppered with cotton wool (4.16) covered with Kraft paper (4.17) and immerse the tube in the water bath at 100 °C for 5 min (4.3).

9. Procedure

9.1 Enzymatic reaction

Prepare the tubes in duplicate at the minimum.

In 5 x 15-mL tubes (4.11) numbered from 1 to 5 and placed in a tray (4.19),

use the 200- μL precision syringe (4.8) to add 200 μL enzymatic solution at 2 g/L (8.1), then

use the 1-mL precision syringe (4.8.1) to add 400 μL sodium acetate buffer (6.2) and

600 μ L 2% oat-spelt xylan (6.3), and start the stopwatch (4.6)
After stirring (4.12), place the tubes stoppered with cotton wool (4.16)
and Kraft paper (4.17) in the water bath at 40 °C (4.2):

- for 1 min for tube 1,
- for 2 min for tube 2,
- for 5 min for tube 3,
- for 10 min for tube 4,
- for 20 min for tube 5.

The reaction is stopped by placing each of the tubes numbered from 1 to 5 immediately in the water bath at 100 °C (4.3) for 10 min after they have been removed from the water bath at 40 °C.

Cool the tubes under a current of cold water.

9.2 Determination of liberated reducing substances (xylose in this case)

In a 15-mL tube (4.11),
place 1 mL reaction medium (9.1),
add 1 mL solution C (6.1.3),
after stirring (4.12), place the tube in a water bath at 100 °C (4.3) for 10 min.

Then cool the tube under a current of cold water.

Add 1 mL solution D (6.1.4),
add 9.5 mL water (5.14) using the 10-mL straight pipette (4.9)
wait 10 min for colour stabilisation.

Centrifuge (4.5) each of the tubes at 5000 rpm for 10 min.

Place the supernatant in a cuvette (4.20).

Immediately measure the absorbance at 520 nm, using a spectrophotometer (4.10).

9.3 Blanks

Proceed as described in 9.1, replacing the enzymatic solution at 2 g/L (8.1) by the heat-denatured blank (8.2). Ideally perform the enzymatic reaction of the blanks at the same time as that of the enzymatic solution.

9.4 Calibration range

Proceed as described in 9.2, replacing the reaction medium (9.1) by the different media of the xylose calibration range from 0 to 400 $\mu\text{g/mL}$ (7).

10. Calculation

10.1 Kinetics

Generally, calculation of enzymatic activity may only be carried out when the substrate and the enzyme are not in limited quantities. This therefore refers to the ascending phase of the representation of kinetics: the enzymatic activity is linear over time. Otherwise, the activity would be underestimated (Figure 1).

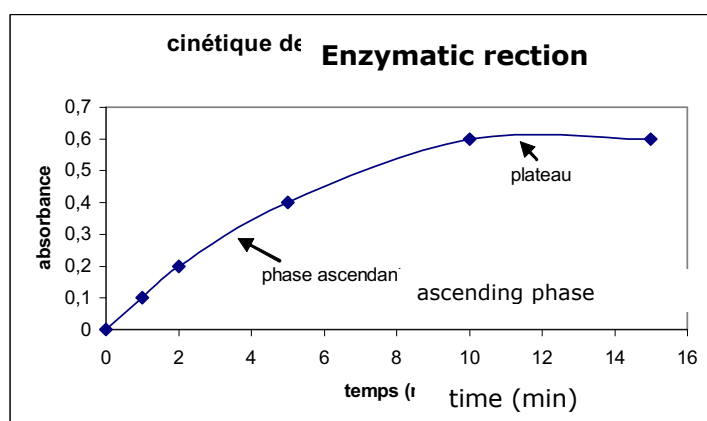

Figure 1: Enzymatic reaction kinetics

Determine the kinetics over 15 min. Measure the activity concerned at $T=1$ min $T=2$ min, $T=5$ min, $T=10$ min and $T=15$ min.

After determining the enzymatic reaction kinetics, plot the curve for the absorbance variation in relation to the reaction time. The absorbance corresponds to the difference between the absorbance at time T of the enzymatic preparation and of the corresponding blank.

Then calculate the equation (1) of the regression line, considering the points of the ascending phase (see Figure 1).

10.2 Calibration line

For the calibration line, plot a graph showing the different concentrations of the xylose calibration range (0-1,89 $\mu\text{mol/mL}$) as the abscissa and the corresponding optical density values as the ordinates, obtained in 9.4. Then calculate the slope (Q/T) of the regression line (2) resulting from the linearity of the graph data.

10.3 Calculation of enzymatic activity

Based on the regression line (1), calculate the absorbance for a mean time, T (e.g. 4 min in the case of Figure 1), by deducing from it quantity Q of xylose released (in micromoles) for this intermediary time using equation (2).

The enzymatic activity in U/g of preparation is calculated as follows:

$$\text{Activity in U/g} = 1000 \times (Q/T)/(V \times C)$$

Where Q: quantity of xylose released in μmols during time T (min),
V: quantity of enzymatic solution introduced (mL) – 0.2 mL in this case,
C: concentration of enzymatic solution (g/L) – 2 g/L in this case.

The enzymatic activity in nanokatals:

$$\text{Activity in nkat/g} = (\text{activity in U/g}) \times (1000/60)$$

This unit corresponds to the number of nanomoles of product formed per second.

11. Method characteristics

$$\begin{aligned} r &= 0.056 \\ R &= 0.056 \\ S_r &= 0.02 \\ S_R &= 0.02 \end{aligned}$$

The repeatability of the method is estimated using the mean standard deviation of the absorbance values derived from the same sampling of the enzymatic preparation, determined 5 times. Therefore, for the determination of xylanase the mean standard deviation of the values is 0.02 with a percentage of error of 9.7%. The % error corresponds to the following:

$$\frac{(\text{mean standard deviation of values} \times 100)}{\text{mean test value}}$$

As such, the method of determination as presented is deemed repeatable.

The reproducibility tests were carried out using 2 enzymatic preparations with 5 samplings for each one.

There were 2 tests used in order to determine the satisfactory reproducibility of the method:

- Variance analysis (study of the probability of the occurrence of differences between samplings). Variance analysis is a statistical method that makes it possible to test the hypothesis of homogeneity of a series of k-means. Carrying out variance analysis consists of determining whether the 'treatment' effect is 'significant or not'.
- The power of the test for type I α -risk (5%). The type I α risk is the risk of concluding that the identical treatments are in fact different.

If the power is low ($\cong 20\%$), this means that no difference has been detected between treatments, yet there is little chance of seeing a difference if one really does exist.

If the power is high ($\cong 80\%$), this means that no difference has been detected between treatments, however, if one does exist, the means are available to see it.

The results are given in Table 2.

Determination	Variance analysis hypotheses	Probability	Test power ($\alpha = 5\%$)	Newman-Keuls test (*)	Bonferroni test (**)
Xylanase	Respected	0.00087	93%	Significant	Significant

Table 2: Variance analysis – study of the sampling effect

* Newman-Keuls test: this comparison test of means makes it possible to constitute homogenous treatment groups: those belonging to the same group are considered as not being different to the given type I α -risk.

** Bonferroni test: also called the 'corrected t-test', the Bonferroni test makes it possible to carry out all comparisons of pairs of means, i.e. (t

$(t-1) / 2$ comparisons before treatments, respecting the given type I α -risk.

Therefore, the tests put in place make it possible to see a difference if there really is one (high test power); in addition, the method of determination shows a probability of occurrence of differences in activity (between samplings) of less than 5%, strengthened by membership of the same group (Newman-Keuls test non-significant) and considered as not being different to the given type I α -risk (Bonferroni test non-significant).

12. Bibliographic references

Nelson, N., 'A photometric adaptation of the SOMOGYI method for the determination of glucose', *Journal of Biological Chemistry*, May Institute for Medical Research of the Jewish Hospital, vol. 153, 1944, pp. 375-380.

Doco, T., *et al.*, 'Polysaccharides from grape berry cell walls. Part II. Structural characterization of the xyloglucan polysaccharides', *Carbohydrate Polymers*, vol. 53, Issue 3, 15 August 2003, pp. 253-261.

**DETERMINATION OF BETA-GLUCANASE (β 1-3, β 1-6) ACTIVITY
IN ENZYME PREPARATIONS****EC 3.2.1.6 (CAS N°62213-14-3): ENDO (1-3) BETA-GLUCANASE****EC 3.2.1.58 (CAS N°9073-49-8): EXO (1-3) BETA-GLUCANASE****EC 3.2.1.75 (CAS N°37278-39-0) : ENDO (1-6) BETA-GLUCANASE**

OIV/OENO 340/2010

OIV-OENO 488-201

General specifications

These enzymatic activities are usually present within a complex enzymatic preparation. In the degradation of β -glucans from *Botrytis cinerea*, endo- β -glucanase activities of the type endo- β -1,3 and of the type exo- β -1,6 glucosidase, as well as exo- β -1,3 type activities are involved. They are summarized here under the commonly used term, " β -glucanases". These enzymatic preparations are also capable of degrading β -glucans in the cell walls of dying *Saccharomyces* yeast cells which supports the process called "élevage de vin sur lie" (aging of wine laying on lees). Endo- β -1,3 activities, endo- β -1,6 activities as well as exo- β -1,3 and exo- β -1,6 activities are involved in this process. Unless otherwise stipulated, the specifications must comply with resolution OENO 365-2009 concerning the general specifications for enzymatic preparations included in the International Oenological Codex.

1. ORIGIN

Reference should be made to paragraph 5, "Sources of enzymes and fermentation environment", of the general monograph on Enzymatic preparations.

The enzyme preparations containing β -glucanase activities are produced by direct fermentations, for example, of *Trichoderma harzianum*, *Trichoderma longibrachiatum* (*T. reesei*) and *Penicillium funiculosum*.

2. SCOPE OF APPLICATION

Reference should be made to the International Code of Oenological Practices, OENO 11/04; 12/04; 15/04, 27/04 and 3/85.

The enzymatic preparations containing β 1-3 and β 1-6 glucanase activities are able to hydrolyse the glucan produced by *Botrytis cinerea* (noble rot and gray rot). This polysaccharide causes great difficulties

during wine clarification and filtration. Such β -glucanases are therefore specifically used for clarification and filtration of wines made from botrytised grapes.

The glucans contained in the yeast cell walls are also hydrolysed by these β -glucanases. They may be used to improve the process of maturing on lees as well as the filterability.

3. PRINCIPLE

The method of analysis is based on measuring the glucose released by the enzyme, using a standardised solution of *Schizophyllum sp.* glucan as substrate.

3.1 Definition of units

A unit of β -glucanase (β -Glu-U) is defined as the quantity of reducing sugars, expressed as glucose, released in test conditions by 1 g (or 1 mL) of enzyme per minute.

3.2 Role of the enzyme

As it grows on infected grapes (as noble or grey rot), *Botrytis cinerea* excretes a β -1,3-glucan which, at every third unit of glucose, possesses a β -1,6 glycosylated residue of glucose (Fig. 1). This glucan is very similar to glucan synthesised by *Schizophyllum sp.*

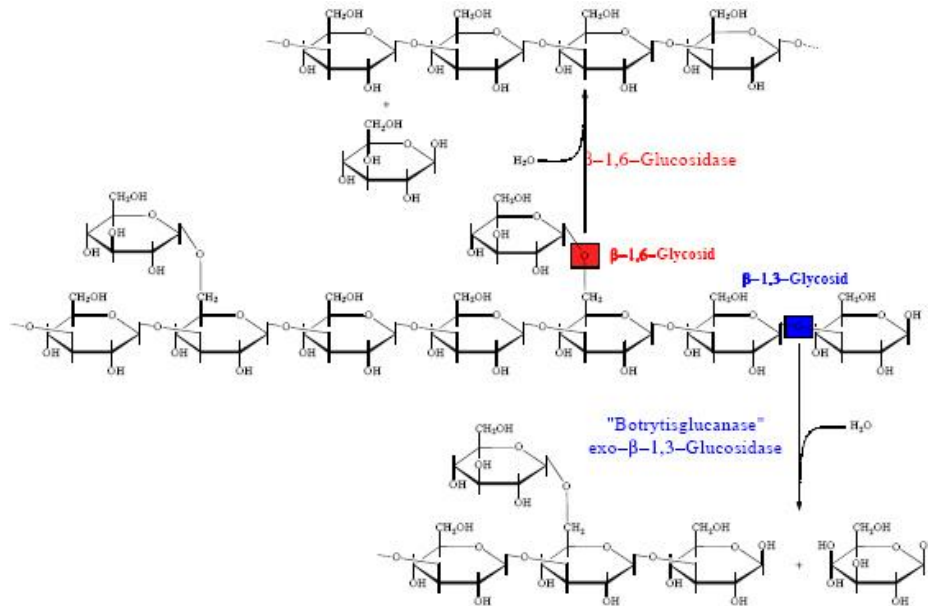

3.3 Principle of measurement

The enzymatic activity releases glucose which, in an alkaline salt solution, reduces 3,5-dinitrosalicylic acid to 3-amino-5-nitrosalicylic acid. The addition of phenol increases the sensitivity of the reaction. Sodium bisulphite serves to stabilise colour.

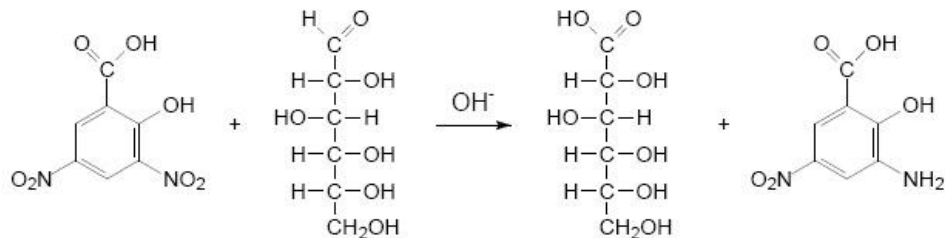

4. APPARATUS

- 4.1 Spectrophotometer and cuvettes with an optical path length of 1 cm
- 4.2 40°C, 100°C water bath
- 4.3 Standard magnetic stirrer
- 4.4 Submersible multi-point magnetic stirrer set at 300 rpm

- 4.5 Measuring containers (volumetric flasks, beakers, conical flasks, etc.)
- 4.6 Beaker
- 4.7 Micro-pipettes
- 4.8 Timer
- 4.9 Ultrasonic bath
- 4.10 pH meter

5. REAGENTS AND PRODUCTS

5.1 Substrate

Glucan stock solution supplied by the University of Braunschweig¹; the glucan content of which has been determined by the University of Braunschweig.

5.2 Pure products

- 5.2.1 Citric acid monohydrate (CAS No. 5949-29-1)
- 5.2.2 Sodium hydroxide (CAS No. 1310-73-2)
- 5.2.3 Potassium sodium tartrate (CAS No. 304-59-6)
- 5.2.4 Sodium metabisulphite Na₂S₂O₅ (CAS No. 7681-57-4)
- 5.2.5 Phenol (CAS No. 108-95-2)
- 5.2.6 Anhydrous glucose
- 5.2.7 3,5-dinitro-2-hydroxybenzoic (3,5-dinitrosalicylic) acid (CAS No. 609-99-4)
- 5.2.8 Distilled water

5.3 Solutions

5.3.1 1M sodium hydroxide solution

In a 100-mL volumetric flask, dissolve 4.0 g of sodium hydroxide (5.2.2) in distilled water (5.2.8) and make up to the required volume.

5.3.2 Citrate buffer solution (pH 4.0) - 0.2 mol/L

In a 500-mL volumetric flask, dissolve 21.0 g of citric acid monohydrate (5.2.1) in 400 mL of distilled water, then adjust the pH to 4.0 with a molar solution of sodium hydroxide (5.3.1) and make up to the required volume with distilled water (5.2.8).

¹ Prof. Dr Udo Rau, Technical University Braunschweig, Department of Biochemistry and Biotechnology Spielmannstr. 7, 38106 Braunschweig - Germany

5.3.3 Citrate buffer solution (pH 4.0) - 0.1 mol/L

In a 1,000-mL volumetric flask, dissolve 21.0 g of citric acid monohydrate (5.2.1) in 900 mL of distilled water (5.2.8), then adjust the pH to 4.0 with a molar solution of sodium hydroxide (5.3.1) and make up to the required volume with distilled water (5.2.8).

5.3.4 Titrating solution: DNS (dinitrosalicylic) acid colour reagent with phenol

This is prepared from solutions A, B and C below:

5.3.4.1 *Solution A:*

Weigh out 154.2 g of potassium sodium tartrate (5.2.3) in an 800-mL beaker and dissolve completely in 500 mL of distilled water (5.2.8). Add 9.7 g of sodium hydroxide (5.2.2).

5.3.4.2 *Solution B:*

In a 2,000-mL beaker, completely dissolve 5.3 g of 3,5-dinitrosalicylic acid (5.2.7) in 500 mL of distilled water (5.2.8). The best results are obtained using an ultrasonic bath.

5.3.4.3 *Solution C:*

In a 100-mL beaker, dissolve 4.2 g of phenol (5.2.5) in 50 mL of distilled water (5.2.8). Then add 1g of sodium hydroxide (5.2.2) and, when completely dissolved, 4.2 g of sodium metabisulphite (5.2.4) and dissolve again.

5.3.4.4 *0.3% glucose solution*

In a 100-mL volumetric flask, put exactly 300 mg of glucose (5.2.6), dissolve in distilled water (5.2.8) and make up to the required volume with distilled water.

5.3.4.5 *DNS acid colour reagent with phenol*

Solutions A and C are mixed with solution B in a 2,000-mL beaker, which is then covered with aluminium foil.

Before using, keep in the dark for at least 3 days.

Transfer the reagent to a brown glass container.

If stored in a dark place at 15-20° C, this solution can be kept for a month.

For each newly-prepared reagent and before each measurement, a new calibration is carried out prior to each enzyme analysis.

Before each use, 3 mL of 0.3% glucose solution (5.3.3.4) should be added to 200 mL of the DNS acid colour reagent with phenol.

5.3.5 Glucan in solution at 0.1%, pH 4.0

Weigh out the exact quantity of glucan stock solution (5.1) to obtain a final concentration of 1 g /L.

The final substrate solution should contain 50% of the citrate buffer solution (pH 4.0) - 0.2 mol/L (5.3.2).

To obtain 100 mL of substrate solution from the glucan stock solution (5.1) (actually containing 5.2 g/L), weigh out 19.2 g in a 100-mL beaker. Add 50 mL of the citrate buffer solution (pH 4.0) - 0.2 mol/L (5.3.2). Homogenize the glucan mixture by stirring for at least 15 minutes. When well-mixed, adjust the pH to 4.0 with a sodium hydroxide molar solution (5.3.1). Then transfer the solution to a 100-mL volumetric flask and make up to the required volume later with distilled water (5.2.8).

Store all glucan stock solutions at ambient temperature. If a new glucan stock solution is used, a glucan substrate factor (G_f = glucan factor) should be determined by means of the standard enzyme. The " G_f " is essential for comparing the results from previous glucan stock solutions with the new ones. The " G_f " is calculated with the values measured considering that standard enzymatic activity is 10,000 β -Glu U/g in the formula (See: Calculation of enzymatic activity).

5.4 Enzyme preparations

5.4.1 Glucanase standard enzyme solution:

Dissolve 0.5 g of glucanase standard enzyme preparation in 25 mL of the citrate buffer solution (pH 4.0; 0.1 mol/L) (5.3.3) and make up to 100 mL with distilled water (5.2.8).

5.4.2 For all other enzyme preparations:

Dissolve 1 mL of enzyme preparation or 0.5 g of solid powdered or granulated enzyme preparation in 25 mL of the citrate buffer solution (pH 4.0; 0.1 mol/L) (5.3.3) and make up to 100 mL with distilled water (5.2.8). If the absorption values are too high or too low (absorbance range 0.1-0.6),

appropriate dilution is necessary. The enzyme dilution should contain 25% of citrate buffer solution (5.3.3).

6. PROCEDURE

6.1 Reagent "blank" test

Add 7 mL of DNS acid colour reagent with phenol (5.3.4) to 3 mL of distilled water (5.2.8) in a 50-mL volumetric flask and heat for exactly 10 minutes over a bath of boiling water. Cool for 5 minutes in an ice bath, then transfer the flask into a water bath at 20° C and add distilled water (5.2.8) to just below the mark. After 10 minutes at 20°C, make up to the required volume.

6.2 Glucose calibration curve with DNS acid colour reagent with phenol

Dissolve 2.00 g of glucose (5.2.6) in a 200-mL volumetric flask and make up to volume with distilled water (5.2.8). Using this solution, prepare the following dilutions:

No.	V solution	standard glucose/100 mL	glucose (μg) in the trial (= 0.5 mL)
1	2 mL	20 mg	100 μg
2	5 mL	50 mg	250 μg
3	10 mL	100 mg	500 μg
4	15 mL	150 mg	750 μg
5	20 mL	200 mg	1,000 μg
6	30 mL	300 mg	1,500 μg
7	40 mL	400 mg	2,000 μg

Use a pipette to put 0.5 mL of each glucose dilution into a 50-mL volumetric flask and add 7 mL of DNS colour reagent with phenol (5.3.4) and 2.5 mL of distilled water (5.2.8). Heat the measuring containers for exactly 10 minutes in a bath of boiling water. Cool for 5 minutes in a bath of ice, then transfer the flask to a water bath at 20°C and add distilled water (5.2.8) to just below the mark. After 10 minutes at 20°C, make up to volume. Measure the absorbance of the solutions within the next 15 minutes, using a spectrophotometer with a wavelength of 515 nm against the "blank" (reagent alone).

On a diagram, plot the quantity of glucose released in the test against the absorbance at 515 nm (Fig. 2).

The calibration curve is produced the same day before every enzyme analysis.

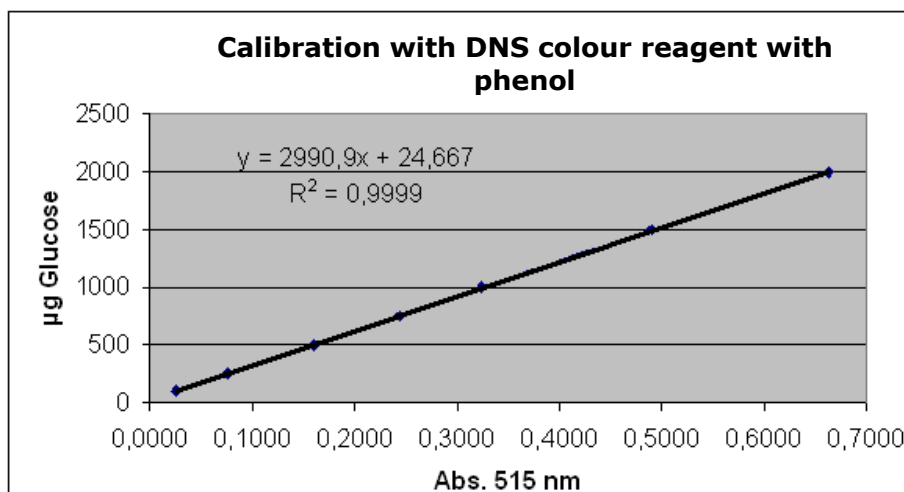

Figure 2

6.3 "Blank" testing of enzymes

Use a pipette to put 0.5 mL of each enzyme solution (5.4.1 or 5.4.2) into a 50-mL volumetric flask and add 7 mL of DNS acid colour reagent with phenol (5.3.4). Mix carefully and add 2.5 mL of substrate solution (5.3.5). Stir well by hand. Then heat all samples over a bath of boiling water for exactly 10 minutes, cool for 5 minutes in a bath of ice and transfer the flask to a water bath at 20° C, adding distilled water (5.2.8) to just below the mark. After 10 minutes at 20° C, make up to volume. Measure the absorbance of the solutions within the next 15 minutes, using a spectrophotometer with a wavelength of 515 nm against the "blank" (reagent alone).

6.4 Measuring the activity of enzyme preparations

For each sample of enzymes, put 10 mL of substrate (5.3.5) into a conical flask in a water bath at 40° C for 5 minutes. Samples should be homogenized using a submersible multi-point magnetic stirrer set at 300 rpm. After 5 minutes, 2 mL of the enzyme solution (5.4.1 or 5.4.2) are added to the first sample and a timer started just after adding the first enzyme solution.

Then add the following enzyme solutions to all the other samples with an interval of 30 seconds between samples.

Samples should then be stirred at 300 rpm throughout the entire reaction time.

After exactly 15 minutes, remove 3 mL of the first mixture, followed by all the other samples, at intervals of 30 seconds.

Using a pipette, put each 3-mL mixture into as many 50-mL volumetric flasks as required, each of which contains 7 mL of DNS acid colour reagent with phenol (5.3.4).

Then heat all the samples, at 30-second intervals, for exactly 10 minutes over a bath of boiling water.

Cool for 5 minutes in a bath of ice, transfer the flask to a water bath at 20° C and add distilled water (5.2.8) to just below the mark.

After 10 minutes at 20° C, make up to volume. Measure the absorbance of the solutions within the next 15 minutes, using a spectrophotometer with a wavelength of 515 nm against the "blank" (reagent alone).

The difference in the absorbance between the "blank" reading of

enzymes and the value after reaction should be between 0.1 and 0.6 absorbance units.

If the values are over the measuring range of the calibration curve, repeat the experiment with dilutions adapted to the enzymes.

For all enzymes, always prepare 1 "blank" enzyme reading and 2 values after reaction. The two values after reaction should be similar.

7. CALCULATIONS

To calculate the enzyme activity, use the mean value of the two readings.

The enzymatic activity of an enzyme preparation is calculated according to the following formula:

$$\beta\text{-Glu-Unit activity/g or mL} = (G \times 200)/(15 \times E) \times 1/G_f$$

$$\text{Nkat/g or mL} = (\text{Activity } \beta\text{-Glu-Unit/g or mL}) \times (1000/60)$$

Where:

G = Quantity of reducing sugars released during the test (reducing sugars released by Δ = the mean of 2 repetitions of the absorbance after reaction minus the absorbance of the "blank" enzyme, calculated in glucose from the glucose calibration curve in μg).

E = Quantity of enzyme diluted to 100 mL in g or mL

200 = Dilution factor

15 = Reaction time in min

G_f = Glucan factor (to be calculated)

Example of a calculation:

Enzyme	Measured value		"Blank" enzyme	E	μg glucose	β -Glu units /g or mL
	1	2				
Enzyme used	0.621	0.618	0.415	0.503	662	10325
<i>Penicillium funiculosum</i> β -Glucanase	0.417	0.416	0.023	1	1249	9799

Gf calculation:

- 1 Measure using old substrate and standard enzyme (Value 1)
- 2 Measure using new substrate and standard enzyme (Value 2)

Calculation: Value 1 / Value 2

8. BIBLIOGRAPHY

Bertrand A. Détermination de l'activité β -glucanase de *Botrytis* des préparations enzymatiques, OIV FV 1263.

MEASUREMENT OF CINNAMOYL ESTERASE ACTIVITY IN ENZYMATIC PREPARATIONSOENO 6/2007;
OIV-OENO 487-2013

Two different methods are proposed to measure the cinnamyl esterase activity since we have no principal precursor, para-coumaroyltartric acid; the first-method uses the chlorogenase activity of *Aspergillus niger* i.e. the hydrolysis of chlorogenic acid (caffeoylquinic); this requires the implementation of conventional enzymatic measuring apparatus.

The second method relates to the hydrolysis of ethyl cinnamate, the content of which is measured by gas chromatography.

Both methods were compared, their give similar results.

GENERAL SPECIFICATIONS

Unless otherwise stipulated, the specifications must comply with the resolution Oeno 365 - 2009 concerning the general specifications for enzymatic preparations included in the International Oenological Codex.

1. Origin

These enzymatic activities are often present in preparations like pectolytic enzymes by directed fermentations of *Aspergillus sp.*

2. Scope of application

This activity is responsible for the production of volatile phenols which impacts negatively the sensory properties of wines, especially white wines. On the other hand, only limited studies have demonstrated that this activity seems to have a positive effect in stabilising the colour of red wines.

3. Method A. CHLOROGENATE HYDROLASE or CHLOROGENASE (EC. 3.1.1.42 – CAS no. 74082-59-0)**3.1 Principle**

Cinnamyl esterase degrades chlorogenic acid releasing caffeic acid. The reduction in measured absorbance at 350 nm linked to the disappearance of this substrate can be used to quantify the cinnamyl esterase activity.

An enzymatic unit is defined as being the quantity of enzyme enabling a drop in the absorbance of 1 unit at pH 6.5 and 30°C.

3.2 Apparatus

- 3.2.1 water bath at 30°C
- 3.2.2 water bath at 100°C
- 3.2.3 2 litre graduated flask
- 3.2.4 125-mL Erlenmeyer flask
- 3.2.5 100-mL graduated flask
- 3.2.6 1000-mL graduated flask
- 3.2.7 chronometer
- 3.2.8 100- μ L precision syringe
- 3.2.9 1000- μ L precision syringe
- 3.2.10 5000- μ L precision syringe
- 3.2.11 graduated 5-mL straight pipette
- 3.2.12 pH-meter
- 3.2.13 spectrophotometer
- 3.2.14 15 mL glass screw-top test tubes
- 3.2.15 metal rack for 15-mL test tubes
- 3.2.16 cuvetts with a 1-cm optical path length, for single use, for spectrophotometer, for measurement in the UV spectrum
- 3.2.17 stirrer of the Vortex type

3.3 Products

- 3.3.1 methanol (Analytical Reagent Rank - CH₃OH - PM = 32.04 g/mole)
- 3.3.2 sodium dihydrogenophosphate (NaH₂PO₄.2H₂O 99% pure - PM = 156.01 g/mole)
- 3.3.3 sodium hydroxide (NaOH 99% pure - PM = 40 g/mole)
- 3.3.4 chlorogenic acid (95% pure - PM = 354.30 g/mole)
- 3.3.5 distilled water
- 3.3.6 commercial enzymatic preparation for analysis

3.4 Solutions

3.4.1 Methanol at 80% (v/v)
Introduce 100 mL of methanol (3.3.1) into a 125-mL Erlenmeyer flask (3.2.4) to which 25 mL of distilled water (3.3.5) have been added.

3.4.2 Sodium hydroxide solution at 9M:
Introduce 360g of sodium hydroxide (3.3.3) into a 1000-mL graduated flask (3.2.6) and make up with distilled water (3.3.5).

3.4.3 Phosphate buffer 0.1M (pH 6.5)

Introduce 31.5 g of sodium dihydrogenophosphate (3.3.2) into a 2-litres graduated flask (3.2.3) to which 1.8 litres distilled water (3.3.5) have been added.

Adjust the pH to 6.5 using the sodium hydroxide solution (3.4.2) and a pH-meter

(3.2.11). Then adjust the volume with 2 litres with distilled water (3.3.5).

3.4.4 Chlorogenic acid solution at 0.06% (p/v)

Dissolve 0.06 g of chlorogenic acid (3.3.4) in a 100-mL graduated flask (3.2.5) to which the phosphate buffer (3.4.3) has been added up to the gauge line.

3.5 Preparation of the sample

It is important to homogenise the enzymatic preparation before sampling, by upturning the container for example. The enzymatic solution and the blanks will have to be prepared extemporaneously.

3.5.1 Enzymatic solution at 10 g/L

Place 1g of commercial preparation (3.3.6) in a 100-mL graduated flask (3.2.5), make up with the phosphate buffer (3.4.3), and stir (3.2.17) in order to obtain a homogeneous mixture.

3.5.2. White denatured by heating

Place 10 mL of the enzymatic solution at 10 g/L (3.5.1) in a 15-mL test tube (3.2.14) and immerse the tube for 5 minutes in the water bath at 100°C (3.2.2).

3.6 Procedure

3.6.1 Enzymatic reaction: The test tubes are produced at least in duplicate.

In 4 x 15-mL test tubes (3.2.14) numbered from 1 to 4, placed in a rack (3.2.15)

Introduce 100 µL of the enzymatic solution at 10 g/L (3.5.1), using the precision syringe (3.2.8),

500 µL of the chlorogenic acid solution (3.4.4), start the chronometer (3.2.7).

After shaking (3.2.17), the test tubes are placed in the water bath at 30°C (3.2.1)

for 120 min. for test tube no.1

for 240 min. for test tube no.2

for 330 min. for test tube no.3
for 400 min. for test tube no.4

The reaction is stopped by adding 5 mL of methanol at 80% (3.4.1) using a straight pipette (3.2.11) in each of the numbered tube 1 to 4, immediately after they have been removed from the water bath at 30°C. The tubes are then shaken.

3.6.2 Proportioning of the released substances (caffeic acid)

The reactional medium (3.6.1) is placed in a cuvet with a 1-cm optical path length (3.2.16). Immediately measure the absorbance at 350 Nm, using a spectrophotometer (3.2.13). The measurement is to be compared with a blank of methanol 80% pure (3.4.1).

3.7 Calculations

3.7.1 Determining the kinetics

In general, calculating the enzymatic activity can only be done when the substrate and the enzyme are not in limiting quantities. This therefore refers to the ascending phase of the kinetic representation: the enzymatic activity is linear in time. Otherwise, the activity would be underestimated (Figure 1)

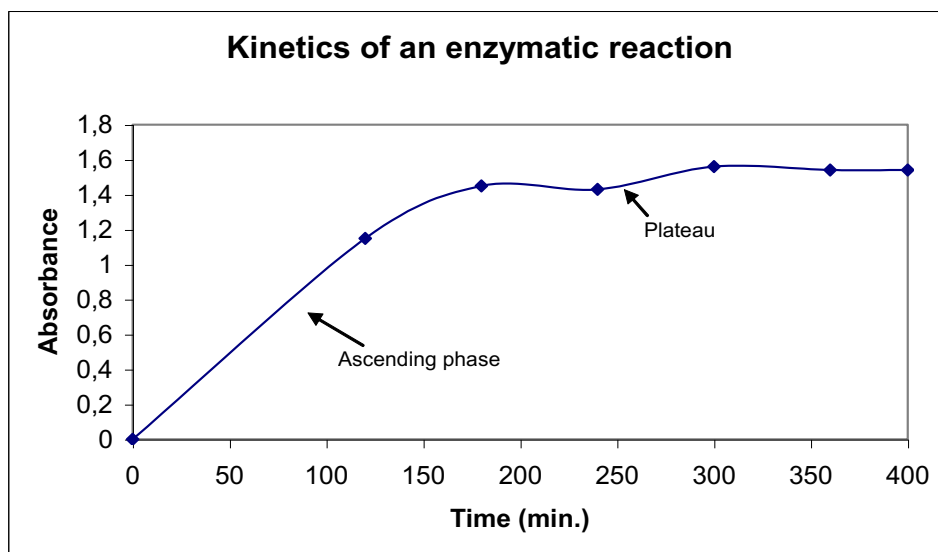

Figure 1: Kinetics of an enzymatic reaction

The kinetics is determined over 400 minutes. The activity concerned is measured at T=120 min T=180 min, T=240 min, T=300 min T=360 min T=400 min.

After determining the kinetics of the enzymatic reaction, plot the curve for the variation in absorbance in relation to reaction time. The absorbance corresponds to the difference between the absorbance at time T of the enzymatic preparation and that of the corresponding blank.

Then calculate the equation (1) of the straight regression line, taking into account only the points of the ascending phase (see figure 1).

3.7.2 Calculation of the enzymatic activity

The cinnamyl esterase activity is calculated based on the reduction in absorbance per hour since this activity is very weak in the preparations. The calculation formula is as follows

$$\text{Activity in U/g} = 1000 \times ((\text{DOO} - \text{DOT})/\text{T}) / (\text{V} \times \text{C})$$

DOO: Value of the absorbance of the blank

DOT: Value of the absorbance at time T (hour)

V: quantity of enzymatic solution introduced (μL), in this case 100 μL

C: concentration of the enzymatic solution (g/L), in this case 10 g/L

4. Method B. HYDROLYSIS OF ETHYL CINNAMATE

4.1 Principle

Cinnamyl esterase hydrolyses ethyl cinnamate. The reduction in this ester measured by gas chromatography can be used to quantify the cinnamyl esterase activity.

4.2 Apparatus

4.2.1 Gas phase chromatograph with a flame ionisation detector or mass spectrometry equipped with a capillary tube of the Carbowax 20 M type 50 m x 0.2 mm x 0.2 μm phase thickness

4.2.2 Magnetic stirrer and stirrer bars

4.2.3 Laboratory glassware (5-mL precision pipettes, conical flasks, 50-mL and 100- mL graduated flasks, 10-mL, 60-mL, 150-mL laboratory glass bottles etc.)

4.2.4 Pasteur pipettes

4.2.5 200- μL , 50- μL and 10- μL precision syringes

4.2.6 Drying oven at 25°C

4.2.7 Precision balance to within 0.1 mg/L

4.2.8 pH-meter

4.3 Products

4.3.1 Methanol (Analytical Reagent Rank - CH₃OH - PM = 32.04 g/mole)

4.3.2 Citric acid 99% pure

4.3.3 Sodium hydroxide (NaOH 99% pure - PM = 40 g/mole)

4.3.4 Ethyl cinnamate (99% pure - PM = 176 g/mole)

4.3.5 Distilled or permuted water

4.3.6 Commercial enzymatic preparation for analysis

4.3.7 Pure ethanol 99% vol.

4.3.8 Diethyl ether 99% pure.

4.3.9 Pure Dodecanol

4.4 Solutions

4.4.1 Ethanol at 12% (v/v)

Introduce 12 mL of ethanol (4.3.7) into a 100-mL graduated flask (4.2.3) make up to volume with distilled water (3.3.5).

4.4.2 Sodium hydroxide solution 4 M

Introduce 16 g of pure sodium hydroxide into a 100-mL graduated flask; make up with distilled water; stir until dissolution.

4.4.3 Citrate buffer at pH 6.5

Introduce 0.05 g of citric acid (4.3.2) into a 150 mL bottle (4.2.3), add 100 mL of ethanol to 12% vol. (4.4.1) dissolve using a magnetic stirrer. Place under magnetic stirring in the presence of the electrode of the pH-meter (4.2.8) bring to pH 6.5 by adding the sodium hydroxide 4 M drop by drop (4.4.2).

4.4.4 Stock solution of ethyl cinnamate at 500 mg/L

Using a precision syringe (4.2.5) place 50 µL of ethyl cinnamate (4.3.4) in a 100-mL graduated flask containing a little pure ethanol (4.3.7) make up to the gauge line with pure ethanol (4.3.7); homogenise

4.4.5 Ethyl cinnamate solution at 25 mg/L in the citrate buffer

In a 100-mL graduated flask, place 5 mL of stock solution of ethyl cinnamate at

500 mg/L (4.4.4) measured with a precision pipette (4.2.3); make up to 100 mL with the citrate buffer at pH 6.5 vol. (4.4.3). Homogenise.

Note: a more concentrated ethyl cinnamate solution must not be prepared because the ester is liable to be partially insoluble.

4.4.6 Dodecanol solution at 0.5 g/L (internal standard)

Using a precision syringe (4.2.5) place 50 µL of pure dodecanol (4.3.9) in a 100-mL graduated flask containing a little pure ethanol (4.3.7); make up the gauge line with pure ethanol (4.3.7); homogenise.

4.5 Preparation of the sample

It is important to homogenise the enzymatic preparation before sampling, by upturning the container for example.

4.6 Procedure

4.6.1 Enzymatic reaction: In a 60-mL laboratory flask, place 50 mL of ethyl cinnamate solution at 25 mg/L (4.4.5) add approximately 100 mg of the commercial enzymatic preparation to be analysed (4.3.6) weighed with precision (4.2.7), i.e. weight P.

After stirring (4.2.2), the bottle is plugged and left on the laboratory bench or if possible in a drying oven at 25°C (4.2.6)

4.6.2 A sample of 200 µL is taken with a precision syringe (4.2.5) after 3 hours, 24 hours, 72 hours.

4.6.3 The reaction is stopped by adding the sample (4.6.2) of 200 µL in a 10-mL flask containing 0.5 mL of methanol (4.3.1) and 1 mL of ether (4.3.8)

4.6.4 Addition of the internal standard

In the preparation (4.6.3), using a precision syringe (4.2.5) add 50 µL of dodecanol to 500 mg/L (4.4.6); homogenise.

4.6.5 Blank

Proceed as in 4.6.3 and 4.6.4 without adding the 200 µL of the sample from the enzymatic reaction (4.6.2)

4.6.6 Reference solution

Proceed as in 4.6.3 and 4.6.4 by placing in the bottle (4.2.3) 200 µL of ethyl cinnamate solution at 25 mg/L (4.4.5) instead of the sample of enzymatic reaction (4.6.2)

4.6.7 Chromatography

4.6.7.1 Inject 2 µL of the blank (4.6.5) into the chromatograph to locate the internal standard. Start the temperature programmer and the data acquisition.

4.6.7.2 Inject 2 µL of reference solution to locate the ethyl cinnamate (ec) and the internal standard (is); measure their respective surface areas Sec0 Sis0

4.6.7.3 Under the same conditions as 4.6.7.2 inject the samples (4.6.4) after 3 hours, after 24 hours and after 72 hours, i.e. the respective surface areas of residual ethyl cinnamate and internal standard S3 and Sis3; S24 Sis24, S72 Sis72.

Determine the quantity of residual ethyl cinnamate for each sample; for example for 72 hours.

$$EC72 = \frac{25 \times Sis0}{SEC0} \times \frac{SCE72}{Sis72}$$

EC consumed in 72 hours = 25 - EC 72

Cinnamyl esterase activity in mg of hydrolysed ethyl cinnamate per hour and g of enzymatic preparation

$$EC \text{ activity in EC mg/g enzyme/hour} = \frac{25 \times EC72 \times 1000}{P \times 25 \times 72}$$

P = weight of enzyme added in the preparation (6.1) in mg/L.

4.7 Comments: The method has been freely adapted from Barbe (1995).

The reaction taking place at pH 6.5 is much more complete than with the pH in the wine where it is approximately 10 times slower; therefore, if after 72 Hours, only a few mg of ethyl cinnamate have been degraded, the EC activity in the wine can be considered negligible.

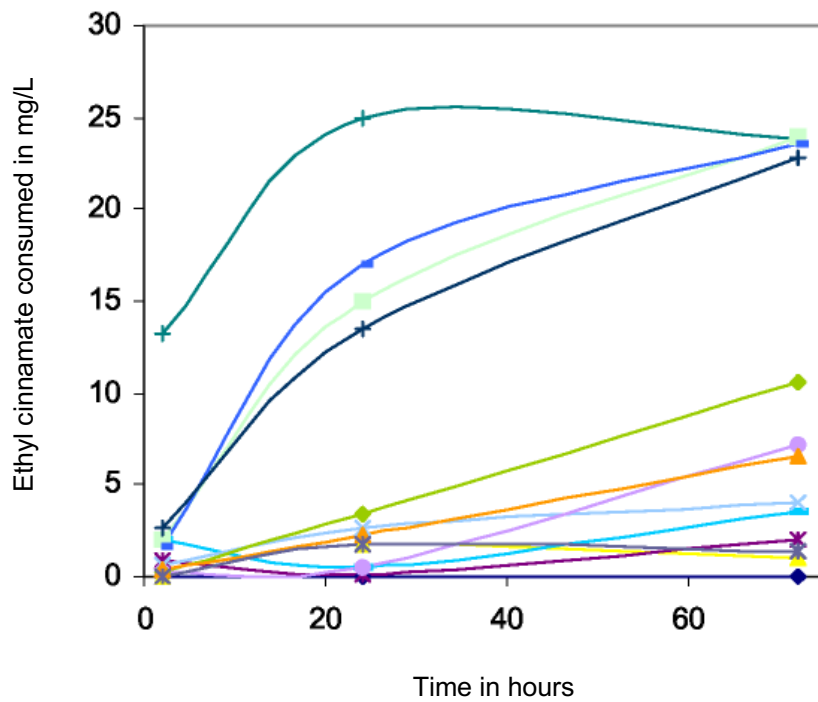

Examples of cinnamoyl esterase activities measured at pH 6.5, of commercial enzymatic preparations.

7. Bibliography

Barbe CH, 1995: On the contaminating esterase activities of pectolytic preparations. PhD Thesis, Univer

**DETERMINATION OF CELLULASE ACTIVITY
IN ENZYMATIC PREPARATIONS****endo-(1 →4)-β-D- glucanase
(EC 3.2.1.4 – CAS N° 9012-54-8)**OENO 8/2008;
OIV-OENO 486B-2012**General specifications**

These enzymes are generally present among other activities, within an enzyme complex. Unless otherwise stipulated, the specifications must comply with the resolution OENO 385–2012 concerning the general specifications for enzyme preparations included in the International Oenological Codex.

1. Origin

Reference is made to paragraph 5 “Source of enzyme and fermentation environment” of the general monography on enzymatic preparation

The enzyme preparations containing this activity are produced by directed fermentations, as exemple, of *Aspergillus Niger*, *Trichoderma longibrachiatum* (*T. reesei*), *Penicillium* sp., *Talaromyces emersonii* or *Rhizopus oryzae*.

2. Scope / Applications

Reference is made to the International Code of Oenological Practices, Oeno 11/04; 12/04; 13/04; 14/04 and 15/04.

Enzymes catalysing the degradation of cellulose-type of grape cell walls polysaccharides, mainly endo-(1 →4)-β-D-glucanases, are useful to speed up and fulfill the maceration process of the grapes. They also have a positive effect on filtration and clarification in allowing a more complete enzymatic degradation of polysaccharides.

3. Principle

The endo-(1→4)-β-D-glucanase catalyses the hydrolysis of the oside bonds within cellulose in a random way. Its activity can therefore be assessed by determination of the reducing sugars (expressed in glucose), released during incubation, by the NELSON method (1944).

Only the activities of the "endo-" type are measured because of the presence of carboxymethyl groups that block the action of the exo-glucanases. The endo-glucanases act inside the chains in non-carboxymethylated regions. In an alkaline environment, the pseudo-aldehydic group of sugars reduces the cupric ions Cu^{2+} . The latter react with the arsenomolybdate reagent to produce a blue colour, whose absorbance, measured at 520 nm, varies linearly with the concentration in monosaccharides (between 0 and 250 $\mu\text{g/ml}$).

4. Apparatus

- 4.1 magnetic stirrer with hot-plate
- 4.2 water bath at 40°C
- 4.3 water bath at 100°C
- 4.4 100-mL beaker
- 4.5 centrifuge capable of housing 15-mL glass test tubes
- 4.6 stop-watch
- 4.7 100-mL graduated flask
 - 4.7.1 500-mL graduated flask
- 4.8. 200- μl precision syringe
 - 4.8.1 1-mL precision syringe
- 4.9 10-mL straight pipette graduated to 1/10 mL
- 4.10 spectrophotometer
- 4.11 15-mL glass test tubes
- 4.12 Vortex-type mixer
- 4.13 500-mL amber glass bottle
- 4.14 room at 4°C
- 4.15 oven at 37°C
- 4.16 cotton-wool
- 4.17 brown paper
- 4.18 pH-meter
- 4.19 metal rack for 15-mL test tubes
- 4.20 disposable spectrophotometer cuvettes with a 1-cm optical path length, for measurement in the visible spectrum
- 4.21 ultrasonic probe

5. Reagents

- 5.1 Sodium acetate (CH_3COONa 99% pure - MW = 82g/mole)
5.2 Acetic acid (CH_3COOH 96% pure - MW = 60 g/mole, density = 1.058)
5.3 Carboxy-methyl-cellulose (CMC) with a degree of substitution from 65 to 95%.
5.4 Cellulase of *Trichoderma reesei* (Fluka, 4U/mg, ref: 22173 as an example). One unit releases 1 μmole of glucose from carboxy-methyl-cellulose per minute.
5.5 Anhydrous sodium sulphate (Na_2SO_4 99.5% pure - MW = 142 g/mole)
5.6 Anhydrous sodium carbonate (Na_2CO_3 99.5% pure - MW = 105.99 g/mole)
5.7 Sodium potassium tartrate ($\text{KNaC}_4\text{H}_4\text{O}_6 \cdot 4\text{H}_2\text{O}$ 99% pure - MW = 282.2 g/mole)
5.8 Anhydrous sodium bicarbonate (NaHCO_3 98% pure - MW = 84.01 g/mole)
5.9 Copper sulfate penta-hydrate ($\text{CuSO}_4 \cdot 5\text{H}_2\text{O}$ 99% pure - MW = 249.68 g/mole)
5.10 Concentrated sulphuric acid (H_2SO_4 98% pure)
5.11 Ammonium heptamolybdate ($(\text{NH}_4)_6\text{Mo}_7\text{O}_{24} \cdot 4\text{H}_2\text{O}$ 99% pure - MW = 1235.86 g/mole)
5.12 Sodium hydrogenoarsenate ($\text{Na}_2\text{HAsO}_4 \cdot 7\text{H}_2\text{O}$ 98.5% pure - MW = 312.02 g/mole). **Given the toxicity of this product, special attention must be paid during manipulation. Waste material must be treated in an appropriate manner.**
5.13 Anhydrous D-glucose ($\text{C}_6\text{H}_{12}\text{O}_6$ 99% pure - MW = 180.16 g/mole)
5.14 Distilled water
5.15 Commercial enzyme preparation for analysis

6. Solutions

6.1 Reagents of the oxidizing solution

These reagents must be prepared first, taking into account the 24-hour lead-time for solution D.

6.1.1 Solution A: place successively in a 100-mL beaker (4.4):

- 20 g of anhydrous sodium sulphate (5.5)
- 2.5 g of anhydrous sodium carbonate (5.6)
- 2.5 g of sodium potassium tartrate (5.7)
- 2 g of anhydrous sodium bicarbonate (5.8)

Dissolve in 80 mL of distilled water (5.14). Heat with stirring (4.1) until dissolution and decant into a 100-mL graduated flask (4.7). Make up to the mark with distilled water (5.14). Maintain at 37°C (4.15); if a deposit is formed, filter using a folded filter.

6.1.2 Solution B:

Dissolve 15 g of copper sulfate pentahydrate (5.9) in 100 mL of distilled water (5.14) and add a drop of concentrated sulphuric acid (5.10). Maintain at 4°C.

6.1.3 Solution C:

This solution is prepared just before use in order to have a satisfactory proportionality between the depth of colour and the quantity of glucose by mixing 1 mL of solution B (6.1.2) with 24 mL of solution A (6.1.1).

6.1.4 Solution D:

In a 500-mL graduated flask (4.7.1), dissolve 25 g of ammonium molybdate (5.11) in 400 mL of water (5.14). Add 25 mL of concentrated sulphuric acid (5.10) (cooled under cold running water).

In a 100-mL beaker (4.4), dissolve 3 g of sodium arsenate (5.12) in 25 mL of water (5.14) and quantitatively transfer into the 500-mL graduated flask (4.7.1) containing ammonium molybdate (5.11).

Make up to the mark with water (5.14) .

Place at 37°C (4.15) for 24 hours then maintain at 4°C (4.14) in a 500 mL amber glass bottle (4.13).

6.2 Sodium acetate buffer (pH 4.2, 100 mM)

This consists of solutions A and B below.

6.2.1 Solution A: sodium acetate 0.1 M: dissolve 0.5 g of sodium acetate (5.1) in 60 mL of distilled water (5.14)

6.2.2 Solution B: acetic acid 0.1 M: dilute 1 mL of acetic acid (5.2) with 175 mL of distilled water (5.14)

6.2.3 Preparing the sodium acetate buffer: mix 23.9 mL of solution A (6.2.1) + 76.1 mL of solution B (6.2.2).

Check the pH of the buffer using a pH-meter (4.18).

The solution must be maintained at 4°C (4.14).

6.3 Carboxy-methyl-cellulose solution (CMC) at 2% (p/v) to be prepared just before use

Into a 100-mL graduated flask (4.7) introduce 2 g of CMC (5.3) and 100 mL of distilled water (5.14)

Given the high viscosity and in order to have a homogeneous solution, it must be subject to ultrasonic treatment (4.21), stirred without heating (4.1) and kept in suspension while constantly stirring.

6.4 Stock glucose solution at 250 µg/mL

In a 100-mL graduated flask (4.7), dissolve 0.0250g of glucose (5.13) in distilled water (5.14), and make up to 100 ml.

7. Preparing the standard solutions of glucose

This is produced using the stock solution of glucose at 250 µg/mL (6.4.), as indicated in Table 1.

Table 1: standard solutions of glucose based on the stock solution

Glucose (µg/ml)	0	25	50	100	150	200	250
Glucose (µmole/ml)	0	0.139	0.278	0.555	0.833	1.110	1.388
Vol. (µl) stock solution (6.4)	0	100	200	400	600	800	1000
Vol. (µl) distilled water (5.14)	1000	900	800	600	400	200	0

8. Preparation of the sample

It is important to homogenise the enzyme preparation before sampling, by upturning the container for example. The enzyme solution and the blanks have to be prepared at the time of use.

8.1 Enzyme solution at 2 g/l to be prepared just before use

Place 200 mg of commercial preparation (5.15) in a 100-mL graduated flask (4.7), make up to the mark with distilled water (5.14), and shake in order to obtain a homogeneous mixture.

8.2. Blank denatured by heating to be prepared just before use

Place 10 mL of the enzyme solution at 2 g/l (8.1) in a 15-mL test tube (4.11), plug with cotton-wool (4.16) covered with brown paper (4.17) and immerse the test tube for 5 minutes in the water bath at 100°C (4.3). Then chill and centrifuge 5 min at 6500 g

9. Procedure

9.1 Enzyme kinetics: The test tubes are prepared at least in duplicate.

In 5 x 15-mL test tubes (4.11) numbered from 1 to 5, placed in a rack (4.19) in a water bath at 40°C, introduce

200 µl of the enzyme solution at 2 g/l (8.1), using the precision syringe (4.8),

400 µl of sodium acetate buffer (6.2), using the precision syringe (4.8.1),

600 µl of the carboxy-methyl-cellulose solution (6.3) previously warmed at 40°C in a water bath, start the stop-watch (4.6).

After mixing (4.12), the test tubes plugged with cotton-wool (4.16) and brown paper (4.17) are replaced in the water bath at 40°C (4.2)

for 1 min. for test tube N°1

for 2 min. for test tube N°2

for 5 min. for test tube N°3

for 10 min. for test tube N°4

for 15 min. for test tube N°5

The reaction is stopped by placing each of the test tubes numbered from 1 to 5, immediately after they have been removed from the water bath at 40°C, in the water bath at 100°C (4.3) for 10 min.

The test tubes are then cooled under running cold water.

Note: the kinetic point at 10 min permits the evaluation of the enzymatic activity

9.2 Determination of the reducing substances released

In a 15-mL test tube (4.11):

Place 1 mL of the reaction mixture (9.1)

Add 1 mL of solution C (6.1.3)

After shaking (4.12), the test tube is placed in the water bath at 100°C (4.3) for 10 min. The test tube is then cooled under running cold water.

Add 1 mL of solution D (6.1.4)

Add 9.5 mL of water (5.14) using the graduated 10-mL pipette (4.9)
Wait 10 min. for the colour to stabilise.
Centrifuge (4.5) each test tube at 2340 g for 10 min.
Place the supernatant liquid in a cuvette (4.20).
Zero the spectrophotometer using distilled water.
Immediately measure the absorbance at 520 nm (4.10).

9.3 Blanks

Proceed as described in 9.1, replacing the enzymatic solution at 2 g/l (8.1) by the blank denatured by heat (8.2). For each kinetic point, the enzymatic reaction of each blank is carried out at the same time as that of the enzymatic solution.

9.4 Standard solutions

Proceed as described in 9.2, replacing the reaction mixture (9.1) by the various mixtures of the standard solutions of glucose from 0 to 250 µg/mL (7).

10. Calculations

10.1 Determining the reaction kinetics

In general, calculating the enzymatic activity can only be done when the substrate and the enzyme are not in limiting quantities. This therefore refers to the ascending phase of the kinetic curve: the enzymatic activity is linear in time. Otherwise, the activity would be underestimated (Figure 1).

E-CO

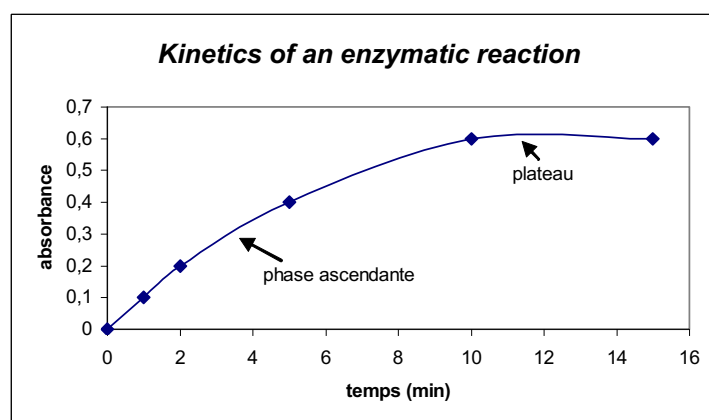

7

ascending phase

Figure 1: Kinetics of an enzymatic reaction

The kinetics are determined over 15 minutes. The activity concerned is measured at T=1 min, T=2 min, T=5 min, T=10 min, T=15 min. After determining the kinetics of the enzymatic reaction, plot the curve for the variation in absorbance in relation to reaction time. The absorbance corresponds to the difference between the absorbance at time T of the enzymatic preparation and that of the corresponding blank. Then calculate the equation (1) of the straight regression line, taking into account only the points of the ascending phase (see figure 1).

10.2 Producing the calibration line

The calibration line corresponds to plotting a graph whose X-coordinates are the various concentrations of the standard range of glucose (from 0 to 0.693 $\mu\text{mole/ml}$) and whose Y-coordinates are the corresponding values of optical densities, obtained in 9.4. Then calculate the (Q/T) slope of the straight regression line (2) resulting from the linearity of the data of the graph.

10.3 Calculating the enzymatic activity

Based on the straight regression line (1) calculate the absorbance for an average time T (for example 4 min. in the case of figure 1) deduct from it the quantity Q of glucose released (in μmoles) for this intermediate time using equation (2).

The formula used to calculate the enzymatic activity in U/g of the preparation is as follows

$$\text{Activity in U/g} = 1000 \times (Q/T)/(V \times C)$$

Where Q: quantity of glucose released in μmoles during time T (min)
 V: quantity of enzyme solution introduced (ml), in this case 0.2 ml
 C: concentration of the enzyme solution (g/l) in this case 2 g/l

It is then possible to express the enzymatic activity in nanokatal. This unit corresponds to the number of nanomoles of product formed per second under the conditions defined by the determination protocols and therefore:

$$\text{Activity in nkat/g} = (\text{activity in U/g}) \times (1000/60)$$

11. 11. Characteristics of the method

r	0.084
R	0.056
Sr	0.03
SR	0.02

The intralaboratory repeatability of the method is estimated using the mean standard deviation of the absorbance values resulting from the same sampling of the enzyme preparation, determined 5 times. In this way, for the determination with carboxy-methyl-cellulose the mean standard deviation of the values is 0.03 with a percentage error of 13.56, in which the % error corresponds to:

$$\frac{(\text{mean standard deviation of values} \times 100)}{\text{mean test value}}$$

In this way, the method of determination as presented is considered repeatable.

INTERNATIONAL OENOLOGICAL CODEX

Cellulase

COEI-1-ACTCEL: 2012

The intralaboratory reproducibility tests were carried out using 2 enzymatic preparations with 5 samplings for each.

2 tests were used in order to determine good reproducibility of the method:

- analysis of variance (the study of the probability of the occurrence of differences between samplings). Analysis of variance is a statistical method used to test the homogeneity hypothesis of a series of K averages. Performing the analysis of variance consists in determining if the "treatment" effect is "significant or not". The standard deviation of reproducibility given by this analysis of variance is 0.02.
- the power of the test for the first type of risk α (5%) – first type of risk α is the risk of deciding that identical treatments are in fact different.

If the power is low ($\cong 20\%$), this means that no difference has been detected between treatments, but there is little chance of seeing a difference if one did in fact exist.

If the power is high ($\cong 80\%$), this means that no difference has been detected between the treatments, but, if there was one, we have the means of seeing it.

The results are given in table 2.

Determination	Variance analysis hypotheses	Probability	Power of Test ($\alpha = 5\%$)	Newman-Keuls test	Bonferroni test (**)
Endo-(1 \rightarrow 4)- β -D-glucanase	Adhered to	0.00011	95%	Significant	Significant

Table 2: Variance analysis – study of the sampling effect

* Newmann-Keuls test: this comparison test of means is used to constitute homogeneous groups of treatments: those belonging to the same group are regarded as not being different to risk α of the first species selected

** Bonferroni test: also referred to as the "corrected T test", the Bonferroni test is used to carry out all the comparisons of pairs of means, i.e., $(t(t-1))/2$ comparisons before treatments, respecting the risk α of the first species selected.

In this way, the tests set up are used to see a difference if there really is one (high power test); in addition, the method of determination involves a probability of occurrence of a discrepancy in activity (between samplings) lower than 5%.

12. Bibliography

NELSON N, A photometric adaptation of the SOMOGYI method for the determination of glucose. The May Institute for medical research of the Jewish hospital, 1944. p 375-380.

Enzymatic activities and their measurement – OIV Document, FV 1226, 2005

**DETERMINATION OF GLYCOSIDASE ACTIVITIES
IN ENZYMATIC PREPARATIONS****(EC 3.2.1.21 - CAS N°9001-22-3)****(EC 3.2.1.23 - CAS N°9031-11-2) ; (EC 3.2.1.37 - CAS N°9025-53-0)****(EC 3.2.1.55 - CAS N°9067-74-7) ; (EC 3.2.1.40 - CAS N°37288-35-0)**

OENO 5/2007;

OIV-OENO 451-2012;

OIV-OENO 489-2012

Introduction

Enzymes of the glycosidase type are used to reveal the flavours of wines based on their glycosylated precursors.

Aromatic molecules are partially in the form of heterosides; they are for the main part associated with glucose; the measurement of enzymatic activity sufficient to break this specific bond has been described under "β-D-glycosidase activity". However, this activity is not really functional if the glucose is itself bound to another type of sugar (which is the case for most aromatic precursors). These are essentially apiose, arabinose, rhamnose and xylose.

In order to measure the true efficiency of an enzymatic preparation so as to obtain the aromatic potential of the grape or wine, the measurement concerning β-D-glucosidase activity should include the measurement of apiofuranosidase, arabinofuranosidase, β-D-galactosidase, rhamnosidase, and xylosidase activities.

**DETERMINATION OF GLUCOSIDASE ACTIVITY
IN ENZYMATIC PREPARATIONS**

(activity β-D-glucosidase)

(EC 3.2.1.21 - CAS no. 9001-22-3)

(OENO 5/2007; 489-2012)

General specifications

These enzymes are usually present among other activities, within an enzymatic complex. Unless otherwise stipulated, the specifications must comply with the resolution OENO 365 - 2009 concerning the general specifications for enzymatic preparations included in the International Oenological Codex.

1. Origin

Reference is made to paragraph 5 "Source of enzyme and fermentation environment" of the general monograph on Enzymatic preparation

The enzymatic preparations containing these activities are produced by directed fermentations of *Aspergillus niger*.

2. Scope/Applications

Reference is made to the International Code of Oenological Practices, Oeno 16/04 and 17/04.

Enzymes belonging to the glycosidase type are used to reveal and enhance the flavours of wines. This is realized through the hydrolysis of the glycosylated aroma precursors. The enzymes can also be added to the wine before the end of alcoholic fermentation but they will become active only after completion of the alcoholic fermentation

3. Principle

The enzymatic hydrolysis of *p*-nitrophenyl- β -D-Glucopyranoside, which is colourless, releases glucose and *para*-Nitrophenol (*p*-Np); the latter turns yellow in the presence of sodium carbonate, the absorbance of which is measured at 400 nm.

4. Apparatus

- 4.1 magnetic stirrer
- 4.2 water bath at 30°C 4.3 water bath at 100°C
- 4.4 cuvetts with a 1-cm optical path length, for single use, for spectrophotometer, for measurement in the visible spectrum
- 4.5 crushed ice
- 4.6 precision syringe 500 – 5000 μ
- 4.7 precision syringe 100 μ l
- 4.8 precision syringe 1000 μ l
- 4.9 spectrophotometer
- 4.10 Eppendorf tubes
- 4.11 100-mL graduated flask
- 4.12 pH-meter
- 4.13 cold room at 4°C

- 4.14 metal rack for Eppendorf tubes
- 4.15 carded cotton
- 4.16 Kraft paper
- 4.17 agitator of the vortex 4.18 chronometer
- 4.19 15-mL glass tubes

5. Products

- 5.1 Sodium carbonate (Na_2CO_3 99.5% pure - PM:105.99 g/mole)
- 5.2 Sodium acetate (CH_3COONa 99% pure - PM: 82g/mole)
- 5.3 Acetic acid (CH_3COOH 96% pure - PM: 60g/mole)
- 5.4 *p*-nitrophenyl- β -D-Glucofuranoside (Fluka, ref. 73676) as an example
- 5.5 β -D-glucosidase (Fluka; 250 mg; 6.3 U/mg, ref. 49290) as an example. One unit corresponds to the quantity of enzyme required to release 1 μ mole of glucose per minute with pH 5 and 35°C.
- 5.6 *p*-nitrophenol (*p* - Np) ($\text{C}_6\text{H}_5\text{NO}_3$ 99.5% pure - PM: 139.11 g/mole)
- 5.7 Distilled water
- 5.8 Commercial enzymatic preparation for analysis

6. Solutions

6.1 Sodium acetate buffer (100 mM, pH 4.2)

It consists of solutions A and B.

- 6.1.1 Solution A: introduce 0.5 g of sodium acetate (5.2) into 60 ml of distilled water (5.7)
- 6.1.2 Solution B: introduce 1 ml of acetic acid (5.3) into 175 mL of distilled water (5.7)
- 6.1.3 Preparation of the sodium acetate buffer: mix 47.8 ml of solution A (6.1.1) + 152 ml of solution B (6.1.2).

Check the pH of the buffer using a pH-meter (4.12).

Maintain at 4°C

6.2 Solution of *p*-nitrophenyl- β -D-Glucofuranoside 4mM

Place 0.096 g of *p*-nitrophenyl- β -D-Glucofuranoside (5.4) in 80 mL of sodium acetate buffer (6.1.).

6.3 Sodium carbonate solution 1M

Dissolve 10.6 g of sodium carbonate (5.1) in 100 mL of water distilled (5.7) in a 100-ml graduated flask (4.11). The solution can be maintained at 4°C (4.13).

6.4 Stock solution of *p*-nitrophenol (*p*-Np) at 125 μ g/ml Dissolve 0.01 g of *p*-Np (5.6) in 80 mL of distilled water (5.7). The stock solution must be prepared extemporaneously.

7. Preparation of the standard range of *p*-nitrophenol (*p* - Np) from 0 to 50 µg/ml

It is made up using the stock solution of *p*-nitrophenol (*p* - Np) (6.4.) as indicated in table 1.

Table 1: Standard range of *para*-Nitrophenol

Quantity of p-Np (µg)	0	2	4	6	8	10
P-Np concentration (µg/mL)	0	10	20	30	40	50
P-Np concentration (µmol/mL)	0	.07222	0.14	0.22	0.29	0.36
Volume of stock solution (6.4) (µl)	0	16	32	48	64	80
Distilled water (5.7) (µl)	200	184	168	152	136	120

8. Preparation of the sample

It is important to homogenise the enzymatic preparation before sampling, by upturning the container for example. The enzymatic solution and the blanks will have to be prepared extemporaneously.

8 1 Enzymatic solution with 10 g/l

Place 1 g of commercial preparation (5.8) in a 100-mL graduated flask (4.11), make up with distilled water (5.7), and stir (4.1) in order to obtain a homogeneous mixture.

8 2 Blank denatured by heating

Place 10 mL of the enzymatic solution at 10 g/l (8.1) in a 15 mL tube (4.19), plug with carded cotton (4.15) covered with Kraft paper (4.16) and immerse the tube for 5 minutes in the water bath to 100°C (4.3).

9. Procedure

9.1 Enzymatic reaction: The tubes are produced at least in duplicate..

In 5 Eppendorf tubes (4.10) numbered 1 to 5, placed in a rack (4.14) in ice crushed (4.5) introduce

100 µl of the solution of *p*-nitrophenyl-β-D-Glucopyranoside (6.2), using a precision syringe (4.7),

100 µl of the enzymatic solution with 2 g/l (8.1), start the chronometer (4.18)

After stirring (4.17), the Eppendorf tubes are placed in the water bath at 30°C (4.2)

for 1 min. for tube no. 1

for 2 min. for tube no.2

for 5 min. for tube no.3

for 10 min. for tube no.4

for 15 min. for tube no.5

The reaction is stopped by placing each of the tubes numbered from 1 to 5 immediately after they have been removed from the water bath at 30°C, in a bath of crushed ice (4.5)

9.2 Determination of *p*-nitrophenol released

From the Eppendorf tubes containing the various reactional mediums (9.1)

Add 600 µl of sodium carbonate solution (6.3), using a precision syringe (4.8),

1.7 ml of distilled water (5.7), using a precision syringe (4.6),

Place the resulting mixture in a tank (4.4).

Immediately measure the absorbance at 400 nm, using a spectrophotometer (4.9)

9.3 Blanks

Proceed as described in 9.1 by replacing the enzymatic solution with 2 g/l (8.1) by the blank denatured by heat (8.2). The ideal situation is to carry out the enzymatic reaction of the blank at the same time as that of the enzymatic solution.

9.4 Standard range

Proceed as described in 9.2 by replacing the reactional medium (9.1) by the various mediums of the standard range of *p-nitrophenol* from 0 to 50 µg/mL (7).

10. Calculations

10.1 Determining the kinetics

In general, calculating the enzymatic activity can only be done when the substrate and the enzyme are not in limiting quantities. This therefore refers to the ascending phase of the kinetic representation: the enzymatic activity is linear in time. Otherwise, the activity would be underestimated (Figure 1).

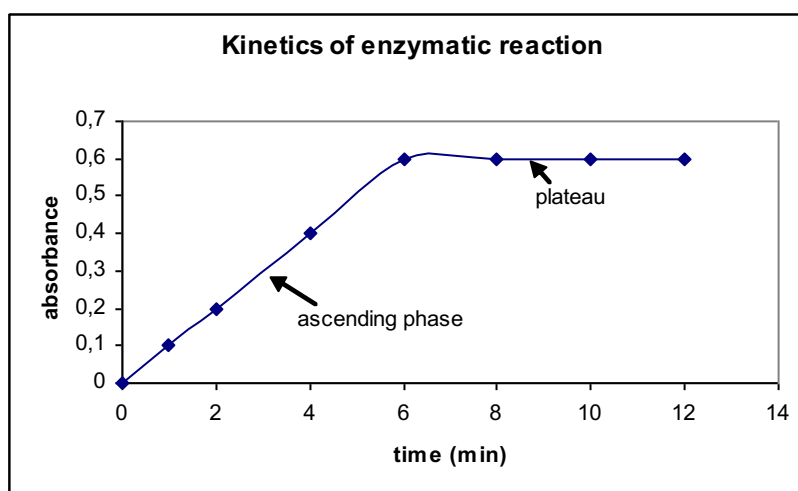

Figure 1: Kinetics of an enzymatic reaction

The kinetics are determined over 12 minutes. The activity concerned is measured at $T=1$ min $T=2$ min, $T=4$ min, $T=6$ min $T=8$ min $T=10$ min, $T=12$ min. After determining the kinetics of the enzymatic reaction, plot the curve for the variation in absorbance in relation to reaction time. The absorbance corresponds to the difference between the absorbance at time T of the enzymatic preparation and that of the corresponding blank. Then calculate the equation (1) of the straight regression line, taking into account only the points of the ascending phase (see figure 1).

10.2 Producing the calibration line

The calibration line corresponds to plotting a graph whose X-coordinates are the various concentrations of the standard range of p -nitrophenol (from 0 to 0.36 $\mu\text{mole/ml}$) and whose Y-coordinates are the corresponding values of optical densities, obtained in 9.4. Then calculate the Q/T slope of the straight regression line (2) resulting from the linearity of the data of the graph.

10.3 Calculating the enzymatic activity

Based on the straight regression line (1) calculate the absorbance for an average time T (for example 4 min. in the case of figure 1) deduct from it the quantity Q of p -nitrophenol released (in μmoles) for this intermediate time using equation (2).

The formula used to calculate the enzymatic activity in U/g of the preparation is as follows

$$\text{Activity in U/g} = 1000 \times (Q/T) / (V \times C)$$

Where Q: quantity of *p*. nitrophenol formed in μmoles during time T (min)

V: quantity of enzymatic solution introduced (ml) here 0.1 ml

C: concentration of the enzymatic solution (g/l) here 2 g/l

It is then possible to express the enzymatic activity in nanokatal. This unit corresponds to the number of nanomoles of product formed per second under the conditions defined by the determination protocols and therefore:

$$\text{Activity in nkat/g} = (\text{activity in U/g}) * (1000/60)$$

11. Characteristics

The repeatability of the method is estimated using the mean standard deviation of the absorbance values resulting from the same sampling of the enzymatic preparation, proportioned 5 times. In this way, to proportion β -D-glucosidase the mean standard deviation of the values is 0.01 with a percentage error of 8.43, in which the % error corresponds to:

$$\frac{(\text{mean standard deviation of values} \times 100)}{\text{mean test value}}$$

In this way, the determination method as presented is considered repeatable. The reproducibility tests were carried out using 2 enzymatic preparations with 5 samplings for each.

2 tests were used in order to determine the satisfactory reproducibility of the method:

- variance analysis (the study of the probability of the occurrence of differences between samplings). Variance analysis is a statistical method

used to test the homogeneity hypothesis of a series of K averages. Performing the variance analysis consists in determining if the "treatment" effect is "significant or not"

- the power of the test for the first species of risk α (5%) – first species of risk α is the risk of deciding that identical treatments are in fact different.

If the power is low (\cong 20%), this means that no difference has been detected between treatments, but there is little chance of seeing a difference if one did in fact exist.

If the power is high (\cong 80%), this means that no difference has been detected between the treatments, but, if there was one, we have the means of seeing it.

The results are given in table 2.

Determination	Variance analysis hypotheses	Probability	Power of test ($\alpha= 5\%$)	Newman-Keuls test(*)	Bonferroni test (**)
β -D-glucosidase	Adhered to	0.0285	42%	Non Significant	Non Significant

Table 2: Variance analysis – study of the sampling effect

* Newmann-Keuls test: this comparison test of means is used to constitute homogeneous groups of treatments: those belonging to the same group are regarded as not being different to risk α of the first species selected

** Bonferroni test: also referred to as the "corrected T test", the Bonferroni test is used to carry out all the comparisons of pairs of means, i.e., (t (t-1))/2 comparisons before treatments, respecting the risk α of the first species selected.

In this way, the tests set up are used to see a difference if there really is one (high power test); in addition, the determination method involves a probability of occurrence of a discrepancy in activity (between samplings) lower than 5%, reinforced by belonging to the same group (Newmann-Keuls test not significant) and considered not to be different to the first species of risk α (Bonferroni test not significant).

**DETERMINATION OF VARIOUS GLYCOSIDASE ACTIVITIES
IN ENZYME PREPARATIONS**

- β-D-galactosidase (EC 3.2.1.23 – CAS n° 9031-11-2)
- α-L-arabinofuranosidase (EC 3.2.1.55 – CAS n° 9067-74-7)
- α -L-rhamnosidase (EC 3.2.1.40 – CAS n° 37288-35-0)
- β-D-xylosidase (EC 3.2.1.34 – CAS n° 9025-53-0)
(Oeno 451-2012)

General specifications

These enzymatic activities are usually present among other activities within an enzymatic complex. Unless otherwise stipulated, the specifications must comply with the resolution Oeno 365 - 2009 concerning the general specifications for enzymatic preparations included in the International Oenological Codex.

1. Origin

Reference is made to paragraph 5 "Source of enzyme and fermentation environment" of the general monograph on Enzymatic preparation

The enzymatic preparations containing these activities are produced by directed fermentations of *Aspergillus niger* for example.

2. Scope/ Applications

Reference is made to the International Code of Oenological Practices, Oeno 16/04 and 17/04.

The glycosidase activities are used to reveal and enhance the flavours of wines based on hydrolysis of the sugar part of their glycosylated precursors. The enzymes can also be added to the must but their technological efficiencies will become active only after completion of the alcoholic fermentation.

3. Principle

Available enzymatic preparations with glycosidase activity contain enzymes that are able to hydrolyse the glycosidic bonds between glucose and other types of sugar, and in

particular: apiose, galactose, arabinose, rhamnose and xylose- which then liberate the aromatic compounds contained in glucose by means of glycosidase activity. Similarly, the enzymes are capable of hydrolysing the bond of synthetic compounds that includes these various types of osidic compounds and *p*-nitrophenol. This enables to measure these different activities.

Determination of β -D-galactosidase activity The enzymatic hydrolysis of β -D- galactopyranoside of *p*-nitrophenyl, which is colourless, liberates galactose and para-nitrophenol (*p*-Np); the latter takes on a yellow colour when mixed with sodium carbonate, the absorbance of which is measured at 400nm.

Determination of α -L-arabinofuranosidase activity

The enzymatic hydrolysis of α -L-arabinofuranoside of *p*-nitrophenyl, which is colourless, liberates arabinose and *p*-nitrophenol (*p*-Np); the latter takes on a yellow colour when mixed with sodium carbonate, the absorbance of which is measured at 400nm.

Determination of α -L-rhamnosidase activity

The enzymatic hydrolysis of α -L-rhamnopyranoside of *p*-nitrophenyl, which is colourless, liberates rhamnose and *p*-nitrophenol (*p*-Np); the latter takes on a yellow colour when mixed with sodium carbonate, the absorbance of which is measured at 400nm.

Determination of β -D-xylosidase activity

The enzymatic hydrolysis of β -D-xylopyranoside of *p*-nitrophenyl, which is colourless, liberates xylose and *p*-nitrophenol (*p*-Np); the latter takes on a yellow colour when mixed with sodium carbonate, the absorbance of which is measured at 400nm.

4. Apparatus

- 4.1 magnetic stirrer
- 4.2 40°C water bath
- 4.3 100°C water bath
- 4.4 single-use 1 cm optical path vats for spectrophotometer measurement in the visible range
- 4.5 crushed ice
- 4.6 precision syringes 500 – 5000 μ l
- 4.7 precision syringe 100 μ l
- 4.8 precision syringe 1000 μ l
- 4.9 spectrophotometer
- 4.10 eppendorf tube

- 4.11 100 ml volumetric flask
- 4.12 pH meter
- 4.13 4°C cold room
- 4.14 metal tray for eppendorf tubes
- 4.15 absorbent cotton
- 4.16 Kraft paper
- 4.17 vortex type stirrer
- 4.18 timer
- 4.19 15 ml glass tubes

5. Products

- 5.1 Sodium carbonate (pure Na₂CO₃ at 99.5% - PM: 105.99 g/mole)
- 5.2 Sodium acetate (pure NaCH₃COO at 99% - PM: 82g/mole)
- 5.3 Acetic acid (pure CH₃COOH at 96% - PM: 60g/mole)
- 5.4 *p*-nitrophenol (*p*-Np) (pure C₆H₅NO₃ at 99.5% - PM: 139.11 g/mole)
- 5.5 Distilled water
- 5.6 Commercial enzymatic preparation to be analysed, and depending on the measurement of the considered activity:
- 5.7a β-D-galactopyranoside de *p*-nitrophenyl (Sigma ref. N1252, 250 mg) as an example
- 5.7b α-L-arabinofuranoside de *p*-nitrophenyl (Sigma ref. N3641, 10 mg) as an example
- 5.7c α-L-rhamnopyranoside de *p*-nitrophenyl (Sigma ref. N7763, 100 mg) as an example
- 5.7d β-D-xylopyranoside de *p*-nitrophenyl (Sigma ref. N2132, 500 mg) as an example

6. Solutions

For the determination of α-L-arabinofuranosidase or α-L-rhamnosidase

- 6.1 Sodium acetate buffer (100 mM, pH 4.4) It is made of solutions A and B.
 - 6.1.1 Solution A: add 0.984 g of sodium acetate (5.2) in 60 ml of distilled water (5.6)
 - 6.1.2 Solution B: add 2 ml of acetic acid (5.3) in 175 ml of distilled water (5.6)
 - 6.1.3 Preparation of the sodium acetate buffer: Add 78 ml of solution A (6.1.1) + 122 ml of solution B (6.1.2).
- Control the pH of the buffer with the pH meter (4.12).

Keep at 4°C

For the determination of β -D-galactosidase or β -D-xylosidase activity

6.1 Sodium acetate buffer (100 mM, pH 4.0) It is made of solutions A and B.

6.1.1 Solution A: add 0.984 g of sodium acetate (5.2) in 60 ml of distilled water (5.6)

6.1.2 Solution B: add 2 ml of acetic acid (5.3) in 175 ml of distilled water (5.6)

6.1.3 Preparation of the sodium acetate buffer: Add 36 ml of solution A (6.1.1) + 164 ml of solution B (6.1.2).

Control the pH of the buffer with the pH meter (4.12).

Keep at 4°C

6.2 Reagent solution (depending on the measurement of the considered enzymatic activity)

a) Solution of *p*-nitrophenyl α -L-arabinofuranoside 4 mM

Add 0.086 g of *p*-nitrophenyl α -L-arabinofuranoside (5.4) in 80 ml of sodium acetate buffer (6.1.).

b) Solution of *p*-nitrophenyl β -D-galactopyranoside 4 mM

Add 0.096 g of *p*-nitrophenyl β -D-galactopyranoside (5.4) in 80 ml of sodium acetate buffer (6.1.).

c) Solution of *p*-nitrophenyl α -L-rhamnopyranoside 4 mM

Add 0.091 g of *p*-nitrophenyl α -L-rhamnopyranoside (5.4) in 80 ml of sodium acetate buffer (6.1.).

d) Solution of *p*-nitrophenyl β -D-xylopyranoside 4 mM

Add 0.0868 g of *p*-nitrophenyl β -D-xylopyranoside (5.4) in 80 ml of sodium acetate buffer (6.1.).

6.3 Solution of sodium carbonate 1M

Dissolve 10.6 g of sodium carbonate (5.1) in 100 ml of distilled water (5.6) in a 100 ml volumetric flask (4.11). The solution may be kept at 4°C (4.13).

6.4 Stock solution of *p*-nitrophenol at 125 μ g/ml

Dissolve 0.01 g of *p*-nitrophenol (5.5) in 80 ml of distilled water (5.6). The stock solution must be prepared extemporaneously.

7. Preparation of the standard range of *p*-nitrophenol from 0 to 100 μ g/ml

It is made of the stock solution of *p*-nitrophenol (6.4.) as indicated in table 1.

Table 1: Standard range of *p*-nitrophenol (*p*.Np)

Quantity of <i>p</i> -Np (µg)	0	4	8	12	16	20
Concentration of <i>p</i> -Np (µg/ml)	0	20	40	60	80	100
Concentration of <i>p</i> -Np (µmol/ml)	0	0.14	0.2	0.43	0.5	0.72
			9		8	
Volume of stock solution (6.4) (µl)	0	16	32	48	64	80
Distilled water (5.5) (µl)	200	184	168	152	136	120

8. Preparation of the sample

It is important that the enzymatic preparation be homogeneous before sampling, by shaking it for example. The enzymatic solution and whites are to be prepared extemporaneously.

8.1 Enzymatic solutions

For the determination of α -L-rhamnosidase or β -D-xylosidase activity

10 g/l enzymatic solution

Put 1 g of commercially available preparation (5.6) in a 100 ml volumetric flask (4.11), add distilled water (5.5), and stir (4.1) in order to achieve a homogeneous solution.

For the determination of α -L-arabinofuranosidase activity

1 g/l enzymatic solution

Put 100 mg of commercially available preparation (5.6) in a 100 ml volumetric flask (4.11), add distilled water (5.5), and stir (4.1) in order to achieve a homogeneous solution.

For the determination of β -D-galactosidase activity

2 g/l enzymatic solution

Put 100 mg of commercially available preparation (5.6) in a 100 ml volumetric flask (4.11), add distilled water (5.5), and stir (4.1) in order to achieve a homogeneous solution.

8.2 Denatured white through heating

Put 10 ml of the enzymatic solution (8.1) in a 15 ml tube (4.19), plug with absorbent cotton (4.15) covered with Kraft paper (4.16) and immerse the tube for 5 minutes in the

100°C water bath (4.3).

9. Procedure

9.1 Enzymatic reaction: The tubes must be at least doubled.

In 6 eppendorf tubes (4.10) numbered from 1 to 6 and placed in a tray (4.14) of crushed ice (4.5), introduce

100 µl of the considered reagent solution (6.2), with a precision syringe (4.7),

100 µl of the corresponding enzymatic solution (8.1), start the timer (4.18)

After stirring (4.17), the eppendorf tubes are placed in the 40°C water bath (4.2)

for 2 mn in tube n° 1 for 5 mn in tube n° 2

for 10 mn in tube n° 3 for 15 mn in tube n° 4 for 20 mn in tube n° 5 for 30 mn in tube n° 6

The reaction is stopped by placing each numbered (1-6) tube immediately after extraction from the 40°C water bath in the tray of crushed ice (4.5).

9.2 Determination of liberated *p*-nitrophenol

With the eppendorf tubes containing the various reactive media (9.1)

add 600 µl of the considered reagent solution (6.3), with a precision syringe (4.8), and

1.7 ml of distilled water (5.5) with a precision syringe (4.6), Place the resulting mixture in a vat (4.4).

Immediately measure the absorbance at 400 nm with a spectrophotometer (4.9)

(This can also be simplified by indicating: See point 8.2 pertaining to the measurement of

β-D-glycosidase activity)

9.3 blank

Proceed as per indications given in point 9.1 by replacing the enzymatic solution (8.1) with whites denatured by heating (8.2). Ideally, the enzymatic reaction of whites should be carried out at the same time as the reaction of the enzymatic solution.

9.4 Standard range

Proceed as described for point 9.2 by replacing the reactive medium (9.1) with various media of the standard range of *p*-nitrophenol from 0 to 100 µg/ml (7).

10. Calculations

10.1 Chemical kinetics

Generally, the calculation of the enzymatic activity can only be carried out when the substrate and the enzyme are not in limiting quantities. This corresponds to the ascending phase of the kinetic representation: the enzymatic activity is linear in time. If this were not to be the case, the activity would be underestimated (Illustration 1).

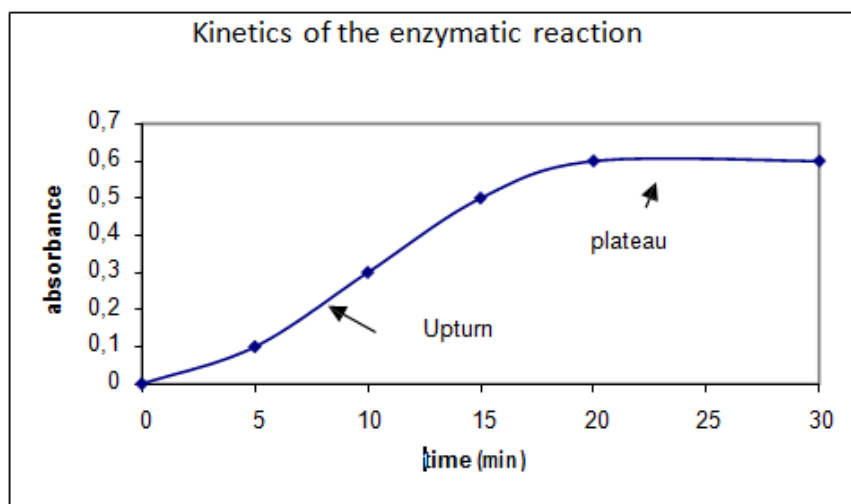

Illustration 1: Kinetic rate of an enzymatic rate

A kinetic calculation is performed for 30 minutes. The activity under consideration is measured at T=2 min, T=5 min, T=10 min, T=15 min, T=20 min, T=30 min.

After having calculated the kinetic rate of the enzymatic reaction, establish the variation curve of absorbance according to reaction times. Absorbance is the difference between absorbance at time T of the enzymatic preparation and the corresponding white.

Then calculate the equation (1) of the regression curve by considering only the points of the ascending phase (see illustration 1).

10.2 Establishing the standard line

The standard calibration line is established in a graph where the x-axis represents the various concentrations of the standard range of the *p*-nitrophenol (0 to 0.72 µmole/ml) and the y-axis represents the various corresponding optical densities established in 8.4. Then calculate the regression curve (2) that results from the linearity of the graph's data.

10.3 Calculation of enzymatic activities

Based on the regression curve (1), calculate the absorbance for an average time of T (for example 4 mn in the case of illustration 1) and deduce the Q quantity of liberated *p*- nitrophenol (in µmoles) for this intermediate time with equation (2).

The formula used to calculate the enzymatic activity at U/g of the preparation is as follows:

$$\text{Activity at U/g} = Q/T/V/C*1000$$

Where Q: quantity of *p*-nitrophenol formed in µmoles during time T (min)

V: quantity of introduced enzymatic solution (ml), in this instance 0.1 ml

C: concentration of the enzymatic solution (g/l), in this instance 10 g/l

It then becomes possible to represent the enzymatic activity in nanokatal. This unit corresponds to the number of nanomoles of the amount of product created per second in the conditions defined in determination protocols, and therefore:

$$\text{Activity in nkat/g} = \text{activity in U /g} *1000/60$$

11. Reproducibility

The reproducibility of the method is estimated with the average of standard deviations of absorbance values resulting from a sample taken from the same enzymatic preparation, determined five times.

The table below summarises the results:

Activity	average of values' standard deviations	error percentage (%)
α -L-arabinofuranosidase	0	5
β -D-galactosidase	0.03	3.78
α -L-rhamnosidase	0.001	4.66
β -D-xylosidase	0.03	3.78

The % of error corresponds to:

$$\frac{(\text{average of standard deviations of the values} \times 100)}{\text{average of trial values}}$$

Hence, the determination method as presented herein is deemed to be reproducible.

The reproducibility trails were carried out with 2 enzymatic preparations and 5 samplings for each.

Two tests were used to determine the proper reproducibility of the method:

- the analysis of variance (the study of the probability of deviations between samples). The variance analysis is a statistical method that enables to test the homogeneity hypothesis of a set of average k values. The variance analysis consists in determining whether the "treatment" effect is "significant or not"
- the strength of the trial with type I error (5%) – type I error is the risk of deciding that identical treatments are different
- If the strength is feeble (\cong 20%), this means that no difference has been detected between treatments, but there is little chance of seeing a difference if there actually were one.
If the strength is high (\cong 80%), this means that no difference has been detected between treatments, but we would have the means of seeing it if such a difference were present.

The results are given in table 2.

Determinations	Hypotheses of variance analysis	Probability	Strength of the trial ($\alpha = 5\%$)	Newman-Keuls test (*)	Bonferroni test (**)
α -L-arabinofuranosidase	Satisfied	0.0125	45%	Not significant	Not significant
β -D-galactosidase	Satisfied	0.01	75%	Not significant	Not significant
α -L-rhamnopyranoside	Satisfied	0.006	65%	Not significant	Not significant
β -D-xylosidase	Satisfied	0.0253	73%	Not significant	Not significant

Table 2: Variance analysis – stuffy of the sampling effect

* Newman-Keuls test: this test is used to compare averages and enables to establish homogeneous treatment groups: those that belong to a same group are considered as not different to the chosen type I error

** Bonferroni test: also known as the "Bonferroni correction" the Bonferroni test enables to carry out all 2 on 2 average comparisons. i.e. $(t(t-1))/2$ comparisons before treatments. respecting the chosen type I error.

Therefore. the tests conducted enable to identify a difference if such a difference exists (high trial strength); furthermore the determination method presents the probability of activity deviations (from one sampling to the next) of less than 5% reinforced by belonging to the same group (non-significant Newmann-Keuls test) and considered to be not different from type I error (non-significant Bonferroni test).

12. Bibliography

- M. Lecas. Thèse de Doctorat. 1994. Composition et structure des polymères constitutifs des parois cellulaires de la pellicule de la baie de raisin. Application d'enzymes fongiques liquéfiant les parois à fins d'extraction des substances odorantes.
- I. Dugelay. Thèse de Doctorat. 1993. L'arôme du raisin : étude des précurseurs hétérosidiques et des activités enzymatiques exogènes impliquées dans leur hydrolyse – Applications technologiques.

**DETERMINATION OF PECTINLYASE ACTIVITY IN
ENZYMATIC PREPARATIONS**

(PECTINLYASE activity)

EC. 4.2.2.10. – CAS no. 9033-35-6)

OIV/OENO 314/2009

OIV-OENO 491-2012

General specifications

These enzymes are generally present among other activities, within an enzyme complex. Unless otherwise stipulated, the specifications must comply with the resolution Oeno 365 – 2009 concerning the general specifications for enzymatic preparations included in the International Oenological Codex.

1. Origin

Reference is made to paragraph 5 “Source of enzyme and fermentation environment” of the general monography on Enzymatic preparation

The enzymatic preparations containing these activities are produced by directed fermentations, as example, of *Aspergillus niger*.

2. Scope/ Applications

Reference is made to the International Code of Oenological Practices, Oeno 11/04; 12/04; 13/04; 14/04 and 15/04.

These enzyme activities are used to support grape maceration and grape juice extraction as well as to help the clarification of musts and wines and finally to improve their filterability.

2. Principle

This enzymatic activity results in the decomposition of highly methylated pectins by the β -elimination of methylated galacturonic acids. In so doing, a system of highly delocalised conjugated double bonds is created, absorbing in the ultraviolet range.

3. Apparatus

4.1 magnetic stirrer

- 4.2 water bath at 25 °C
- 4.3 water bath at 100 °C
- 4.4 1000-mL graduated flask
 - 4.4.1 100-mL graduated flask
- 4.5 chronometer
- 4.6 quartz cuvetts with a 1-cm optical path length, for spectrophotometer, for measurement in the UV spectrum
- 4.7 pH-meter
- 4.8 100- μ L precision syringes
 - 4.8.1 1000- μ L precision syringes
- 4.9 spectrophotometer
- 4.10 15-mL test tubes
- 4.11 shaker of the vortex type
- 4.12 metal rack for 15-mL test tubes
- 4.13 chamber at 4 °C
- 4.14 carded cotton
- 4.15 Kraft paper

4. Products

- 5.1 Citrus fruit pectin with a 63-66 % degree of esterification (Pectin from citrus peel, Fluka, Ref. 76280), as an example.
- 5.2 Sodium hydroxide (NaOH, 99 % pure - PM = 40 g/mole)
- 5.3 Citric acid ($C_6H_8O_7 \cdot H_2O$, 99.5 % pure - PM = 210.14 g/mole)
- 5.4 Sodium dihydrogenophosphate ($NaH_2PO_4 \cdot 2H_2O$, 99 % pure - PM = 156.01 g/mole)
- 5.5 Distilled water
- 5.6 Commercial enzymatic preparation for analysis

5. Solutions

- 6.1 Solution of sodium hydroxide 1M

Introduce 40 g of sodium hydroxide (5.2) into a 1000-mL graduated flask (4.4) and make up with distilled water (5.5).

- 6.2 Mc Ilvaine buffer (Devries *et al*).

It consists of solutions A and B.

- 6.2.1 Solution A: acid citric at 100 mM: dissolve 4.596 g of citric acid (5.3) in 200 mL of distilled water (5.5)
- 6.2.2 Solution B: sodium dihydrogenophosphate at 200 mM: dissolve

6.25 g of sodium dihydrogenophosphate (5.4) in 200 mL of distilled water (5.5).

6.2.3 Preparation of the Mc Ilvaine buffer

Mix 50% of solution A (6.2.1) + 50 % of solution B (6.2.2) and adjust pH to 6 using the solution of sodium hydroxide (6.1).

The solution must be maintained at 4 °C (4.13). Check the pH of the buffer using a pH-meter (4.7)

6.3 Solution of citrus fruit pectin at 1 % (p/v)

Dissolve 0.5 g of pectin (5.1) in 50 mL of Mc Ilvaine buffer (6.2).

7. Preparation of the sample

It is important to homogenise the enzymatic preparation before taking a sample by turning over the recipient, for example. The enzymatic solutions and blanks should be prepared at time of use.

7.1 Enzymatic solution at 10 g/L to be prepared just before use.

Place 1g of commercial preparation (5.6) in a 100-mL graduated flask (4.4.1), make up with distilled water (5.5), stir (4.1) in order to obtain a homogeneous mixture.

7.2. Blank denatured by heating to be prepared just before use

Place 10 mL of the enzymatic solution at 10 g/L (7.1) in a 15-mL test tube (4.10), plug with carded cotton (4.14) covered with Kraft paper (4.15) and immerse the tube for 5 minutes in the water bath at 100°C (4.3). Then chill and centrifuge 5 min at 6500 g.

8. Procedure

8.1 Enzymatic reaction: The test tubes are produced at least in duplicate.

In 5 x 15-mL test tubes (4.10) numbered from 1 to 5, placed in a rack (4.12) in a water bath at 25°C, introduce

400 µL of Mc Ilvaine buffer (6.2) using a 1000-µL precision syringe (4.8.1)

100 µL of the enzymatic solution at 10 g/L (7.1) using a 100-µL precision syringe (4.8)

500 µL of citrus fruit pectin solution (6.3) beforehand warmed at 25°C in water bath; start the chronometer (4.5)

After stirring (4.11), the tubes plugged with carded cotton (4.14) and Kraft paper (4.15), are placed in the water bath at 25 °C (4.2)
for 1 min for tube no.1
for 2 min for tube no.2
for 5 min for tube no.3
for 10 min for tube no.4
for 15 min for tube no.5

The reaction is stopped by rapid (30 seconds max) heating by placing each tube numbered from 1 to 5 in the water bath at 100 °C (4.3) and adding acid or basic concentrated solutions as stop reagent. The tubes are then cooled under running cold water.

8.2 Determination of released substances

The reactional medium (8.1) is diluted to one tenth with distilled water (5.5). The dilution is placed in a cuvet (4.6) with an optical path of 1 cm.

Zero spectrophotometer using distilled water.

Immediately measure the absorbance at 235 nm, using a spectrophotometer (4.9).

8.3 Blank

Proceed as described in 8.1, replacing the enzymatic solution by the blank denatured by heating (7.2). For each kinetic point, the enzymatic reaction of each blank is carried out at the same time as that of the enzymatic solution.

9. Calculations

9.1 Determining the kinetics

In general, calculating the enzymatic activity can only be done when the substrate and the enzyme are not in limiting quantities. This therefore refers to the ascending phase of the kinetic representation: the

enzymatic activity is linear in time. Otherwise, the activity would be underestimated (Figure 1).

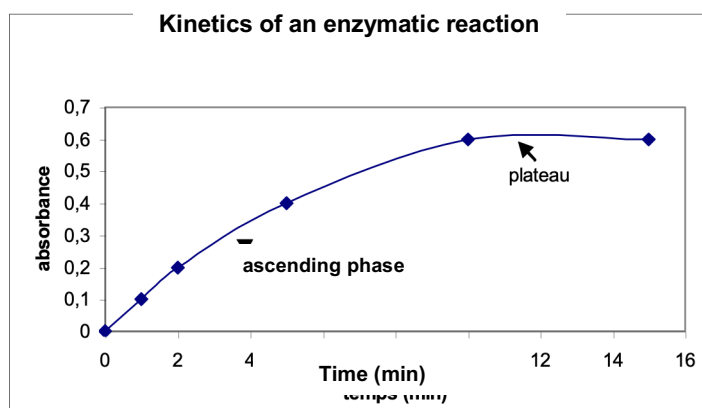

Figure 1: kinetics of enzymatic reaction

The kinetics are determined over 15 minutes. The activity concerned is measured at T=1 min, T=2 min, T=5 min, T=10 min, T=15 min. After determining the kinetics of the enzymatic reaction, plot the curve for the variation in absorbance in relation to reaction time. The absorbance corresponds to the difference between the absorbance at time T of the enzymatic preparation and that of the corresponding blank. Then calculate the DO/T slope (1) of the straight regression line, taking into account only the points of the ascending phase (see figure 1).

9.2 Calculating the enzymatic activity

The enzymatic activity of the pectinlyase is calculated using the molar extinction coefficient of the molecule formed ($\epsilon = 5500 \text{ M}^{-1}\text{cm}^{-1}$). The formula to be applied is as follows:

$$\text{Activity in U/g} = (\text{DOT} / \text{T}) / (0.1 / \text{V}) \times (1000 / (5.5 / \text{C}))$$

Where DO_T : absorbance value at time T (min)

V: quantity of enzymatic solution introduced

(mL): in this case, 0.1 mL

C: concentration of the enzymatic solution

(g/L): in this case 10 g/L

It is then possible to express the enzymatic activity in nanokatal. This unit corresponds to the number of nanomoles of product formed per second under the conditions defined by the determination protocols and

therefore:

$$\boxed{\text{Activity in nkat/g} = (\text{activity in U/g}) \times (1000/60)}$$

10. Characteristics of the method

$$\begin{aligned} r &= 0,028 \\ R &= 0,112 \\ S_r &= 0,01 \\ S_R &= 0,04 \end{aligned}$$

The repeatability of the method is estimated using the mean standard deviation of the absorbance values resulting from the same sampling of the enzymatic preparation, proportioned 5 times. In this way, to proportion the pectinlyase the mean standard deviation of the values is 0.01 with a percentage error of 4.66, in which the % error corresponds to:

$$\frac{(\text{mean standard deviation of values} \times 100)}{\text{mean test value}}$$

In this way, the determination method as presented is considered repeatable.

The reproducibility tests were carried out using 2 enzymatic preparations with 5 samplings for each.

2 tests were used in order to determine the satisfactory reproducibility of the method:

- variance analysis (the study of the probability of the occurrence of differences between samplings). Variance analysis is a statistical method used to test the homogeneity hypothesis of a series of K averages. Performing the variance analysis consists in determining if the "treatment" effect is "significant or not". The

standard deviation of reproductibility given by this variance analysis is 0,04.

- the power of the test for the first species of risk α (5 %) – first species of risk α is the risk of deciding that identical treatments are in fact different.

If the power is low ($\cong 20\%$), this means that no difference has been detected between treatments, but there is little chance of seeing a difference if one did in fact exist.

If the power is high ($\cong 80\%$), this means that no difference has been detected between the treatments, but, if there was one, we have the means of seeing it.

The results are given in table 1.

Determination	Variance analysis hypotheses	Probability	Power of test ($\alpha=5\%$)	Newman-Keuls test (*)	Bonferroni test (**)
PL	Adhered to	0.00725	87 %	Significant	Significant

Table 1: Variance analysis – study of the sampling effect

* Newmann-Keuls test: this comparison test of means is used to constitute homogeneous groups of treatments: those belonging to the same group are regarded as not being different to risk α of the first species selected

** Bonferroni test: also referred to as the "corrected T test", the Bonferroni test is used to carry out all the comparisons of pairs of means, i.e., $(t(t-1))/2$ comparisons before treatments, respecting the risk α of the first species selected.

In this way, the tests set up are used to see a difference if there really is one (high power test); in addition, the determination method involves a probability of occurrence of a discrepancy in activity (between samplings) lower than 5 %.

11. Bibliography

DE VRIES J.A., F. M. ROMBOUTS F.M., VORAGEN A.g.J., PILNIK W.
Enzymic degradation of apple pectins. Carbohydrate Polymers, 2, 1982, 25-33.

**DETERMINATION OF POLYGALACTURONASE ACTIVITY IN
ENZYMATIC PREPARATIONS**

**endo- and exo-polygalacturonase activities (PG)
(EC. 3.2.1.15 – CAS N° 9032-75-1)**

OENO 10/2008;
OIV-OENO 364-2012

General specifications

These enzymes are generally present among other activities, within an enzyme complex, but may also be available in purified form, either by purification from complex pectinases or directly produced with Genetically Modified Microorganisms. Unless otherwise stipulated, the specifications must comply with the resolution Oeno 365 – 2009 concerning the general specifications for enzymatic preparations included in the International Oenological Codex.

1. Origin

Reference is made to paragraph 5 "Sources of enzymes and fermentation environment" of the general monograph on enzymatic preparations.

The enzyme preparations containing such activity are produced by directed fermentations such as *Aspergillus niger*, *Rhizopus oryzae* and *Trichoderma reesei* or *longibrachiatum*

2. Scope /Applications

Reference is made to the International Code of Oenological Practices, Oeno 11/04; 12/04; 13/04; 14/04 and 15/04.

These enzyme activities are used to contribute to the effectiveness of grape maceration and grape juice extraction as well as to help the clarification of musts and wines and finally to improve their filterability.

I. METHODS

1. METHODS 1

2. SCOPE

The method of determination was developed using a commercially available polygalacturonase. The conditions and the method were developed for application to the commercial enzyme preparations such as those found on the oenological market.

3. PRINCIPLE

Polygalacturonases cut pectin chains with a low degree of methylation and thus release the galacturonic acids forming the pectin located at the ends of the chain. Once released, the galacturonic acids are determined by the Nelson method (1944). In an alkaline medium, the pseudo aldehyde group of sugars reduces the cupric ions Cu^{2+} . The latter react with the arsenomolybdate reagent to produce a blue colour, whose absorbance, measured at 520 nm, varies linearly with the concentration in monosaccharides (between 0 and 250 $\mu\text{g}/\text{mL}$).

4. EQUIPMENT

- 4.1 magnetic stirrer with hot-plate
- 4.2 water bath at 40°C
- 4.3 water bath at 100°C
- 4.4 100-ml beaker
- 4.5 centrifuge capable of housing 15-mL glass test tubes
- 4.6 stop-watch
- 4.7 100-ml graduated flask
 - 4.7.1 500-ml graduated flask
- 4.8. 200- μl precision syringe
 - 4.8.1 1-ml precision syringe
- 4.9 10-ml straight pipette graduated to 1/10 mL
- 4.10 spectrophotometer
- 4.11 15-mL glass test tubes
- 4.12 Vortex-type mixer
- 4.13 500-mL amber glass bottle
- 4.14 room at 4°C
- 4.15 drying oven at 37°C
- 4.16 cotton-wool
- 4.17 brown paper

- 4.18 pH-meter
4.19 metal rack for 15-mL test tubes
4.20 disposable spectrophotometer cuvettes with a 1-cm optical path length, for measurement in the visible spectrum.

5. REAGENTS

- 5.1 sodium acetate (CH_3COONa 99% pure - MW = 82g/mole)
5.2 acetic acid (CH_3COOH 96% pure - MW = 60 g/mole, density = 1.058)
5.3 polygalacturonic acid 85% pure. "Polygalacturonic acid sodium salt" from citrus fruit (Sigma, P3 850) is an example.
5.4 anhydrous sodium sulphate (Na_2SO_4 99.5% pure - MW = 142 g/mole)
5.5 anhydrous sodium carbonate (Na_2CO_3 99.5% pure - MW = 105.99 g/mole)
5.6 sodium potassium tartrate ($\text{KNaC}_4\text{H}_2\text{O}_6 \cdot 4\text{H}_2\text{O}$ 99% pure - MW = 282.2 g/mole)
5.7 anhydrous sodium bicarbonate (NaHCO_3 98% pure - MW = 84.01 g/mole)
5.8 copper sulfate penta-hydrated ($\text{CuSO}_4 \cdot 5\text{H}_2\text{O}$ 99% pure - MW = 249.68 g/mole)
5.9 concentrated sulphuric acid (H_2SO_4 98% pure)
5.10 ammonium heptamolybdate ($(\text{NH}_4)_6\text{MO}_7\text{O}_{24} \cdot 4\text{H}_2\text{O}$ 99% pure - MW = 1235.86 g/mole)
5.11 sodium hydrogenoarsenate ($\text{Na}_2\text{HA}_5\text{O}_4 \cdot 7\text{H}_2\text{O}$ 98.5% pure - MW = 312.02 g/mole). **Given the toxicity of this product, special attention must be paid during manipulation. Waste material must be treated in an appropriate manner.**
5.12 D-galacturonic acid ($\text{C}_5\text{H}_{10}\text{O}_7 \cdot \text{H}_2\text{O}$ - MW: 212.16 g/mole)
5.13 distilled water
5.14 commercial enzyme preparation to be analysed

6. SOLUTIONS

6.1 Reagents of the oxidizing solution

These reagents have to be prepared first, taking into account the 24-hour lead-time for solution D.

- 6.1.1 Solution A: Place successively in a 100-mL beaker (4.4):
20 g of anhydrous sodium sulphate (5.4)
2.5 g of anhydrous sodium carbonate (5.5)
2.5 g of sodium potassium tartrate (5.6)
2 g of anhydrous sodium bicarbonate (5.7)

Dissolve in 80 ml of distilled water (5.13). Heat (4.1) until dissolution and transfer into a 100-ml graduated flask (4.7). Make up to the mark with distilled water (5.13). Maintain at 37°C (4.15); if a deposit forms, filter on a folded filter.

6.1.2 Solution B:

Dissolve 15 g of copper sulfate pentahydrate (5.8) in 100 mL of distilled water (5.13) and add a drop of concentrated sulphuric acid (5.9). Maintain at 4°C.

6.1.3 Solution C:

This solution is prepared just before use in order to have a satisfactory proportionality between the depth of colour and the quantity of glucose by mixing 1 mL of solution B (6.1.2) with 24 mL of solution A (6.1.1).

6.1.4 Solution D:

In a 500-mL graduated flask (4.7.1), dissolve 25 g of ammonium molybdate (5.10) in 400 mL of water (5.13). Add 25 ml of concentrated sulphuric acid (5.9) (cooled under running cold water).

In a 100-mL beaker (4.4) dissolve 3 g of sodium arsenate (5.11) in 25 mL of water (5.13) and transfer quantitatively into the 500-mL graduated flask (4.7.1) containing the ammonium molybdate (5.10).

Make up to the mark with water (5.13) to have a final volume of 500 mL.

Place at 37°C (4.15) for 24 hours then maintain at 4°C (4.14) in a 500 mL amber glass bottle (4.13).

6.2 Sodium acetate buffer (pH 4.2, 100 mM)

This consists of solutions A and B.

6.2.1 Solution A: sodium acetate 0.1 M: dissolve 0.5 g of sodium acetate (5.1) in 60 mL of distilled water (5.13)

6.2.2 Solution B: acetic acid 0.1 M: dilute 1 mL of acetic acid (5.2) with 175 mL of distilled water (5.13)

6.2.3 Preparation of the sodium acetate buffer: mix 23.9 ml of solution A (6.2.1) + 76.1 ml of solution B (6.2.2).

Check the pH of the buffer using a pH-meter (4.18).

The solution must be maintained at 4°C (4.14).

6.3 Polygalacturonic acid solution at 0.4 % (p/v)

In a 100 mL graduated flask (4.7) dissolve 0.4 g of polygalacturonic acid (5.3) in 100 mL of sodium acetate buffer (6.2).

The solution must be prepared just before use.

6.4 Stock solution of D-galacturonic acid at 250 µg/ml

In a 100 mL graduated flask (4.7), dissolve 0.0250 g of D-galacturonic acid (5.12) in distilled water (5.13) and make up to 100 mL.

7. PREPARATION OF THE STANDARD SOLUTIONS OF D-GALACTURONIC ACID

The standard range is produced from 0 to 250 µg/mL, according to table 1.

Table 1: standard solutions of D-galacturonic acid

Galacturonic acid (µg/mL)	0	25	50	100	150	200	250
Galacturonic acid (µmole/mL)	0	0.118	0.236	0.471	0.707	0.943	1.178
Vol. (µl) stock solution (6.4)	0	100	200	400	600	800	1000
Vol. (µl) distilled water (5.13)	1000	900	800	600	400	200	0

8. PREPARATION OF THE SAMPLE

It is important to homogenise the enzyme preparation before sampling, by upturning the container for example. The enzyme solution and the blanks will have to be prepared at the time of use.

8.1 Enzyme solution at 1 g/l to be prepared just before use

Place 100 mg of commercial preparation (5.14) in a 100-ml graduated flask (4.7), make up with distilled water (5.13), and stir in order to obtain a homogeneous mixture.

8.2. Blank denatured by heating, to be prepared just before use

Place 10 mL of the enzyme solution at 1 g/l (8.1) in a 15-ml test tube (4.11), plug with cotton wool (4.16) covered with brown paper (4.17) and immerse the test tube for 5 minutes in the water bath at 100°C (4.3). Cool and centrifuge 5 min at 6500 g.

9. PROCEDURE

9.1 Enzyme kinetics: The test tubes are prepared at least in duplicate.

In 5 x 15-ml test tubes (4.11) numbered from 1 to 5, placed in a rack (4.19) in a water bath at 40°C, introduce

200 µl of the enzyme solution at 1 g/l (8.1), using the precision syringe (4.8),

400 µl of distilled water (5.13), using the precision syringe (4.8.1),

600 µl of the polygalacturonic acid (6.3) warmed beforehand at 40°C in a water bath, start the stop-watch (4.6).

After shaking (4.12), the test tubes plugged with cotton-wool (4.16) and brown paper (4.17) are replaced in the water bath at 40°C (4.2)

for 1 min. for test tube N°1

for 2 min. for test tube N°2

for 5 min. for test tube N°3

for 10 min. for test tube N°4

for 15 min. for test tube N°5

The reaction is stopped by placing each of the test tubes numbered from 1 to 5, immediately after they have been removed from the water bath at 40°C, in the water bath at 100°C (4.3) for 10 min.

The test tubes are then cooled under running cold water.

Note: the kinetic point at 10 min is used for the evaluation of the enzyme activity

9.2 Determination of reducing substances released

In a 15-mL test tube (4.11)

Place 1 mL of the reaction medium (9.1) using the precision syringe (4.8.3)

Add 1 mL of solution C (6.1.3) using the precision syringe (4.8.3)

After shaking (4.12), the test tube is placed in the water bath at 100°C (4.3) for 10 min. The test tube is then cooled under running cold water.

Add 1 mL of solution D (6.1.4)

Add 9.5 ml of water (5.13) using the straight 10-mL pipette (4.9)

Wait 10 min. for the colour to stabilise.

Centrifuge (4.5) each test tube at 2430 g for 10 min.

Place the supernatant liquid in a cuvette (4.20).

Zero the spectrophotometer using distilled water

Immediately measure the absorbance at 520 nm, using a spectrophotometer (4.10).

9.3 Blanks

Proceed as described in 9.1, replacing the enzyme solution at 1 g/l (8.1) by the blank denatured by heat (8.2). For each kinetic point, the enzymatic reaction of each blank is carried out at the same time as that of the enzyme solution. .

9.4 Standard solutions

Proceed as described in 9.2, replacing the reaction mixture (9.1) by the various mixtures of the standard solutions of D-galacturonic acid from 0 to 250 µg/mL (7).

10. CALCULATIONS

10.1 Determining the reaction kinetics

In general, calculating the enzymatic activity can only be done when the substrate and the enzyme are not in limiting quantities. This therefore refers to the ascending phase of the kinetic curve: the enzymatic activity is linear in time. Otherwise, the activity would be underestimated (Figure 1).

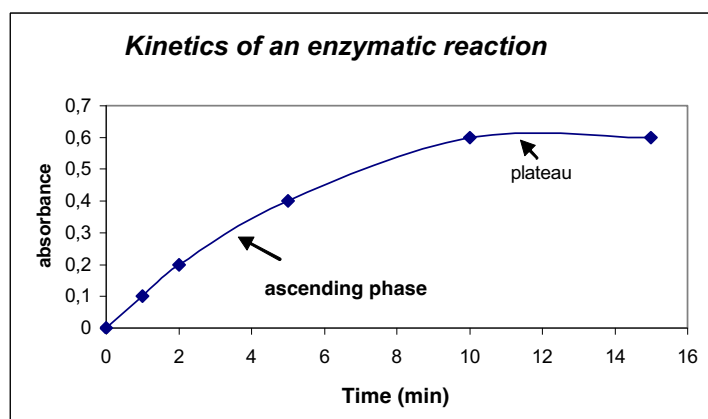

Figure 1: Kinetics of an enzymatic reaction

The kinetics are determined over 15 minutes. The activity concerned is measured at T=1 min T=2 min, T=5 min, T=10 min, T=15 min.

After determining the kinetics of the enzymatic reaction, plot the curve for the variation in absorbance in relation to reaction time. The absorbance corresponds to the difference between the absorbance at time T of the enzyme preparation and that of the corresponding blank. Then calculate the equation (1) of the straight regression line, taking into account only the points of the ascending phase (see figure 1).

10.2 Producing the calibration line

The calibration line corresponds to plotting a graph whose X-coordinates are the various concentrations of the standard solutions of D-galacturonic acid (from 0 to 0.589 $\mu\text{mole/mL}$) and whose Y-coordinates are the corresponding values of optical densities, obtained in 9.4. Then calculate the straight regression slope line (2) resulting from the linearity of the data of the graph.

10.3 Calculating the enzymatic activity

Based on the straight regression line (1) calculate the absorbance for an average time T (for example 4 min. in the case of figure 1) deduct from it the quantity Q of D-galacturonic acid released (in μmoles) for this intermediate time using equation (2).

The formula used to calculate the enzymatic activity in U/g of the preparation is as follows

$$\text{Activity in U/g} = 1000 \times (Q/T)/(V \times C)$$

Where Q: quantity of D-galacturonic acid released in μmoles during time T (min)
 V: quantity of enzyme solution introduced (mL), in this case 0.2 mL
 C: concentration of the enzyme solution (g/l), in this case 1 g/l

It is then possible to express the enzymatic activity in nanokatals. This unit corresponds to the number of nanomoles of product formed per second under the conditions defined by the determination protocols and therefore:

$$\text{Activity in nkat/g} = (\text{activity in U/g}) \times (1000/60)$$

11. CHARACTERISTICS OF THE METHOD

r	0.084
---	-------

INTERNATIONAL OENOLOGICAL CODEX

Polygalacturonase

COEI-1-ACTPGA: 2012

R	0.056
Sr	0.03
SR	0.02

The intralaboratory repeatability of the method is estimated using the mean standard deviation of the absorbance values resulting from the same sampling of the enzyme preparation, determined 5 times. In this way, to analyse the polygalacturonase the mean standard deviation of the values is 0.03 with a percentage error of 3.78, in which the % error corresponds to:

$$\frac{(\text{mean standard deviation of values} \times 100)}{\text{mean test value}}$$

In this way, the determination method as presented is considered repeatable.

The intralaboratory reproducibility tests were carried out using 2 enzyme preparations with 5 samplings for each.

2 tests were used in order to determine the satisfactory reproducibility of the method:

- analysis of variance (the study of the probability of the occurrence of differences between samplings). Analysis of variance is a statistical method used to test the homogeneity hypothesis of a series of K averages. Performing the analysis of variance consists in determining if the "treatment" effect is "significant or not". The standard deviation of reproducibility given by this analysis of variance is 0.02.

- the power of the test for the first type of risk α (5%) – first type of risk α is the risk of deciding that identical treatments are in fact different.

If the power is low ($\cong 20\%$), this means that no difference has been detected between treatments, but there is little chance of seeing a difference if one did in fact exist.

If the power is high ($\cong 80\%$), this means that no difference has been detected between the treatments, but, if there was one, we have the means of seeing it.

The results are given in table 2.

INTERNATIONAL OENOLOGICAL CODEX

Polygalacturonase

COEI-1-ACTPGA: 2012

Determination	Analysis of variance hypotheses	Probability	Power of Test ($\alpha = 5\%$)	Newman-Keuls test	Bonferroni test (**)
PG	Treatment* block interaction	0.0256	77%	Significant	Significant

Table 2: analysis of variance– study of the sampling effect

* Newmann-Keuls test: this comparison test of means is used to constitute homogeneous groups of treatments: those belonging to the same group are regarded as not being different to risk α of the first species selected

** Bonferroni test: also referred to as the "corrected T test", the Bonferroni test is used to carry out all the comparisons of pairs of means, i.e., $(t - 1)/2$ comparisons before treatments, respecting the risk α of the first species selected.

In this way, the tests set up are used to see a difference if there really is one (high power test); in addition, the method of determination involves a probability of occurrence of a discrepancy in activity (between samplings) lower than 5%.

12. BIBLIOGRAPHY

NELSON N, A photometric adaptation of the SOMOGYI method for the determination of glucose. The may Institute for medical research of the Jewish hospital, 1944. p 375-380.

Enzyme activities and their measurement – OIV Document, FV 1226, 2005

Methods 2: Determination of Polygalacturonase activity with cyanoacetamide**1. Principle**

Polygalacturonases cut the principal pectin chains (homogalacturonan domain) with a low degree of methylation. This enzyme activity leads to the release of galacturonic acids along with the homogalacturonan oligomers. Therefore the reducing ends are released. This ultraviolet method with cyanoacetamide, based on KNOEVENAGEL reaction, which means the condensation between an active methylene group and a carbonyl group in a strongly alkaline medium, is existing to find out the activity of various enzymes amongst others of polygalacturonase. It has been developed for the determination of the enzymatic degradation of polysaccharides through an endo- and exo- mechanism that generates reducing monosaccharides.

2. Equipment and materials

- spectrophotometer
- quartz cuvette ($\lambda=274$ nm, optical path length 1 cm)
- analytical scale
- magnetic stirrer and stir bar
- water-bath (40°C; 100°C)
- chronometer
- graduated flasks (different volume)
- beakers (different volume)
- precision pipettes (different volume)
- spectrophotometer
- glass tubes (closable)
- vortex mixer

3. Chemicals and reagents

- polygalacturonic acid, ~95 % enzymatic (CAS 25990-10-7)
- pH 4.0 Na-citrate/HCl buffer, 1.06 g/cm³ (Titrisol), p.a. quality
- pH 9.0 H₃BO₃/KCl/NaOH buffer ≈0.05 M/≈0.05 M/≈0.022M (Titrisol), p.a. quality

- cyanoacetamide, ≥ 98 %, purum (CAS 107-91-5)
- D-galacturonic acid monohydrate ≥ 97 % (CAS 91510-62-2)

4. Preparation of solutions

4.1. Stock solution of D-galacturonic acid (250 $\mu\text{g}/\text{mL}$)

Dissolve 0,025 g of D-galacturonic acid in 100 mL H₂O.

4.2. 1 % cyanoacetamide solution

Dissolve 1 g of cyanoacetamide in 100 mL H₂O

4.3. Borate buffer (pH 9.0)

This precast solution should be diluted according to the description of the producer.

4.4. Na-citrate/HCl buffer (pH 4.0)

This precast solution should be diluted according to the description of the producer.

4.5. Polygalacturonic acid solution

Stirring constantly dissolve polygalacturonic acid very slowly in the concentration of 5 g/l in Na-citrat/HCl buffer (pH 4.0)

5. Performance of enzyme activity determination

5.1. Calibration curve and procedure

The standard range is produced from 0 $\mu\text{g}/\text{mL}$ to 250 $\mu\text{g}/\text{mL}$ of D-galacturonic acid. Use stock solution for dilution.

D-galacturonic acid monohydrate $\mu\text{g}/\text{mL}$	0	25	50	100	150	200	250
D-galacturonic acid monohydrate $\mu\text{mol}/\text{mL}$	0	0.118	0.236	0.471	0.707	0.943	1.178
Stock solution μL	0	100	200	400	600	800	1000
H ₂ O μL	1000	900	800	600	400	200	0

Cyanoacetamide assay: 1 mL of D-galacturonic acid and 2 mL borate buffer (pH 9) and 1 mL of 1 % cyanoacetamide solution are mixed. After incubation in a test tube at 100°C for 10 min, the solution is cooled down in a cold water bath. Then the absorbance must be measured at 274 nm immediately. The photometer must be set to zero with water.

For calculation the intersection point of the regression line must be set to zero.

5.2. Enzymatic hydrolysis and procedure of the sample

For the enzymatic hydrolysis of polygalacturonic acid 10 mL of polygalacturonic acid solution must be heated at 40°C in a closable glass tube. Then 0,01 g of the sample is added and the mixture must be incubated at 40°C. After exactly 5 min and exactly 10 min, 500 µL are removed from the reaction mixture and directly heated up to 100°C in preheated test tubes for 10 min. Afterwards this 500 µL are diluted with water to a total volume of 25 mL.

For analysing the blank the same concentration of enzyme in polygalacturonic acid is heated up to 100 °C for 10 min (the polygalacturonic acid solution must be heated at 100°C before adding the enzyme!). In case of cloudiness the solution should be centrifuged at 5000 rpm for 5 min. Then the blank must also be incubated at 40°C. 500 µL of the blank solution are removed after 5 min and also placed in the water bath at 100°C for 10 min. Afterwards this 500 µL are diluted with water to a total volume of 25 mL.

Cyanoacetamide assay: 1 mL of the diluted solution and 1 mL of 1 % cyanoacetamide solution are added to 2 mL borate buffer (4.3.). After incubation in a test tube at 100°C for 10 min, the solution must be cooled down in a cold water bath. Then the absorbance must be measured at 274 nm immediately.

6. Calculation of the enzymatic activity

Enzymatic activity is calculated by relating the absorbance value and the quantity of product formed using a standard range with the formula:

$$\text{Activity (U/g)} = q / (t * c * F)$$

Activity (nkat/g) = $q / (t * c * F) * (1000 / 60)$

q = quantity of galacturonic acid in $\mu\text{mol/mL}$

t = time in min

c = concentration of the enzymatic solution in g/L (= 0.01 g/L) pro 10 mL substrat

F = correction factor of the volume (=2)

7. Literature

Bach E. and Schollmeyer E. (1992): An Ultraviolet-Spectrophotometric Method with 2-Cyanoacetamide for the Determination of the Enzymatic Degradation of Reducing Polysaccharides. Anal. Biochem. 203, 335-339.

8. Intra-laboratory validation of the determination of the activity of Polygalacturonase with 2- Cyanoacetamide

The mean value of the standard deviation was determined of 6 different enzymes.

Each enzyme was analysed 6 times.

Mean value of the standard deviations of the different enzymes = 6,93 %

INTERNATIONAL OENOLOGICAL CODEX

Polygalacturonase

COEI-1-ACTPGA: 2012

	Enzyme 1 5 min	Enzyme 2 5 min	Enzyme 3 5 min	Enzyme 4 5 min	Enzyme 5 5 min	Enzyme 6 5 min	Enzyme 4 10 min	Enzyme 5 10 min	Enzyme 6 10 min
Mean Value (nkat/g)	7583.9	3896.4	10445.8	8751.7	16894.4	16153.1	8532.5	11608.9	14436.1
Standard Deviation (nkat/g)	1195.6	367.1	445.3	420.4	631.4	908.7	246.48	656.3	1012.3
Standard Deviation %	15.8	9.4	4.3	4.8	3.7	5.6	2.9	5.7	7.0
$s^2(r)$	1191221	112292	165238	147264	332227	688096	50628	358948	853983
$s(r)$	1091.4	335.1	406.5	383.7	576.4	829.5	225.0	599.1	924.1
Repeatability r (nkat/g)	3088.7	948.3	1150.4	1086.0	1631.2	2347.5	636.8	1695.5	2615.2

INTERNATIONAL OENOLOGICAL CODEX

Polygalacturonase

COEI-1-ACTPGA: 2012

Intra-laboratory validation of the determination of the activity of PG with 2-Cyanoacetamide

Enzyme	Absorbance 5 min	Concentration (mg/ml)	U/g	nkat/g	Enzyme 1; 5 min		(X-MW) ²
Enzyme 1	0.1698	0.01	389.2	6487	mean value (nkat/g)	7583.9	1203896.6
Enzyme 1	0.2278	0.01	593.6	9893	standard deviation (nkat/g)	1195.60	5333533.6
Enzyme 1	0.1855	0.01	444.5	7408	standard deviation %	15.77	30819.8
Enzyme 1	0.1815	0.01	430.4	7173	Variance	248.5	168555.9
Enzyme 1	0.1887	0.01	455.9	7598	s ² (r)	1191221.0	208.6
Enzyme 1	0.1776	0.01	416.6	6943	s(r)	1091.4	410311.4
					r (nkat/g) repeatability	3088.7	sum 7147325.9

Enzyme	Absorbance 5 min	Concentration (mg/ml)	U/g	nkat/g	Enzyme 2; 5 min		(X-MW) ²
Enzyme 2	0.0898	0.01	215.2	3587	mean value (nkat/g)	3896.4	95927.9
Enzyme 2	0.0898	0.01	215.3	3588	standard deviation (nkat/g)	367.08	94898.2
Enzyme 2	0.0897	0.01	214.5	3575	standard deviation %	9.42	103290.8
Enzyme 2	0.09	0.01	245.2	4087	Variance	88.76	36205.6
Enzyme 2	0.0954	0.01	245.6	4093	s ² (r)	112292.05	38787.1
Enzyme 2	0.0971	0.01	266.9	4448	s(r)	335.10	304642.7
					r (nkat/g) repeatability	948.33	sum 673752.3

Enzyme	Absorbance 5 min	Concentration (mg/ml)	U/g	nkat/g	Enzyme 3; 5 min		(X-MW) ²
Enzyme 3	0.4077	0.01	613.4	10223	mean value (nkat/g)	10445.83	49506.3
Enzyme 3	0.3937	0.01	588.8	9813	standard deviation (nkat/g)	445.29	400056.3
Enzyme 3	0.4201	0.01	635.3	10588	standard deviation %	4.26	20306.3
Enzyme 3	0.4095	0.01	616.6	10277	Variance	18.2	28617.4
Enzyme 3	0.4381	0.01	666.9	11115	s ² (r)	165237.7	447784.0
Enzyme 3	0.4225	0.01	639.5	10658	s(r)	406.5	45156.3
					r (nkat/g) repeatability	1150.4	sum 991426.4

INTERNATIONAL ENOLOGICAL CODEX

Polygalacturonase

COEI-1-ACTPGA: 2012

Enzyme	Absorbance 5 min	Concentration (mg/ml)	U/g	nkat/g	Enzyme 4; 5 min		(X-MW) ²
					mean value (nkat/g)		
Enzyme 4	0.2032	0.01	530.4	8840	8751.7		7802.8
Enzyme 4	0.19614	0.01	505.5	8425	420.38		106711.1
Enzyme 4	0.21	0.01	555.9	9265	4.80		263511.1
Enzyme 4	0.19188	0.01	490.5	8175	23.1		332544.4
Enzyme 4	0.20858	0.01	549.3	9155	147263.9		162677.8
Enzyme 4	0.3448	0.01	519	8650	383.7		10336.1
					1086.0	sum	883583.3

Enzyme	Absorbance 5 min	Concentration (mg/ml)	U/g	nkat/g	Enzyme 5; 5 min		(X-MW) ²
					mean value (nkat/g)		
Enzyme 5	0.35063	0.01	978.1	16302	16894.4		351385.5
Enzyme 5	0.35329	0.01	987.5	16458	631.40		190192.9
Enzyme 5	0.3812	0.01	1085.7	18095	3.74		1441333.6
Enzyme 5	0.35979	0.01	1010.4	16840	14.0		2964.2
Enzyme 5	0.35941	0.01	1009.1	16818	332226.5		5792.9
Enzyme 5	0.4559	0.01	1011.2	16853	576.4		1690.1
					1631.2	sum	1993359.3

Enzyme	Absorbance 5 min	Concentration (mg/ml)	U/g	nkat/g	Enzyme 6; 5 min		(X-MW) ²
					mean value (nkat/g)		
Enzyme 6	0.30006	0.01	888.5	14808	16153.1		1808277.9
Enzyme 6	0.3108	0.01	926.2	15437	908.69		513213.0
Enzyme 6	0.3348	0.01	1010.9	16848	5.63		483411.2
Enzyme 6	0.3391	0.01	1025.9	17098	31.6		893550.1
Enzyme 6	0.3195	0.01	957	15950	688095.8		41231.6
Enzyme 6	0.5370	0.01	1006.6	16777	829.5		388890.8
					2347.5	sum	4128574.5

Enzyme	Absorbance 10 min	Concentration (mg/ml)	U/g	nkat/g	Enzyme 4; 10 min		(X-MW) ²
					mean value (nkat/g)		
Enzyme 4	0.3355	0.01	498	8300	8532.5		54056.3
Enzyme 4	0.3569	0.01	535.8	8930	246.48		158006.3
Enzyme 4	0.3340	0.01	495.4	8257	2.89		76084.0
Enzyme 4	0.3420	0.01	509.5	8492	8.3		1667.4
Enzyme 4	0.3472	0.01	518.6	8643	50627.5		12284.0
Enzyme 4	0.3448	0.01	514.4	8573	225.0		1667.4
					636.8	sum	303765.3

INTERNATIONAL OENOLOGICAL CODEX

Polygalacturonase

COEI-1-ACTPGA: 2012

Enzyme	Absorbance 10 min	Concentration (mg/ml)	U/g	nkat/g	Enzyme 5; 10 min		
Enzyme 5	0.43542	0.01	638.3	10638	mean value (nkat/g)	11608.9	(X-MW) ²
Enzyme 5	0.49384	0.01	741.2	12353	standard deviation (nkat/g)	656.31	941978.1
Enzyme 5	0.4712	0.01	701.4	11690	standard deviation %	5.65	554197.5
Enzyme 5	0.49213	0.01	738.2	12303	Variance	32.0	6579.0
Enzyme 5	0.46232	0.01	685.7	11428	s ² (r)	358947.8	482253.1
Enzyme 5	0.4559	0.01	674.4	11240	s(r)	599.1	32600.3
					r (nkat/g) repeatability	1695.5	136079.0
							sum 2153687.0

Enzyme	Absorbance 10 min	Concentration (mg/ml)	U/g	nkat/g	Enzyme 6; 10 min		
Enzyme 6	0.60886	0.01	987.9	16465	mean value (nkat/g)	14436.1	(X-MW) ²
Enzyme 6	0.5221	0.01	835.1	13918	standard deviation (nkat/g)	1012.31	4116390.1
Enzyme 6	0.5180	0.01	828.0	13800	standard deviation %	7.01	268093.8
Enzyme 6	0.52344	0.01	837.5	13958	Variance	49.2	404637.3
Enzyme 6	0.52895	0.01	847.2	14120	s ² (r)	853983.0	228271.6
Enzyme 6	0.537	0.01	861.3	14355	s(r)	924.1	99926.2
					r (nkat/g) repeatability	2615.2	6579.0
							sum 5123898.1

mean value of the standard deviations %	6.93
--	------

**COMPARATIVE EVALUATION OF PROTEASE ACTIVITY
(ASPERGILLOPEPSIN I) IN ENZYME PREPARATIONS
(EC 3.4.23.18)
OIV-OENO 625-2021**

1. ORIGIN

Enzyme preparations that have an Aspergillopepsin I activity are formed by controlled fermentation of *Aspergillus* spp., in particular of *Aspergillus niger*.

This enzyme is usually referred to as Aspergillopepsin I or Aspergillus acid protease (EC 3.4.23.18). Proteases are usually present as an enzyme complex. Unless otherwise stated, the specifications of resolution OIV-OENO 365-2009 must comply with "general specifications of enzyme preparations" set out in the International Oenological Code.

Reference is made to paragraph 5 "Source of enzyme and fermentation environment" of the general monography on Enzymatic preparations.

2. SCOPE/APPLICATIONS

Reference is made to the *International Code of Oenological Practices*, OIV-OENO 541A-2021 and OIV-OENO 541B-2021.

Enzymatic preparations containing protease activities (Aspergillopepsin I) are able to degrade the native must or wine protein under specific conditions of heat treatment. These proteins are causing great difficulties during must and wine clarification and stabilization steps. Such Proteases are therefore specifically used for the stabilization of protein rich must and wine.

In order to verify that the treatment has led to the removal of proteases (Aspergillopepsin I) and to the reduction of the native level of proteins, the proteins can be assayed in finished wines using the SDS-PAGE method described in the Appendix I of this monograph.

3. PRINCIPLE

This procedure is only for the determination of proteolytic activity in enzyme preparations, expressed in spectrophotometric acid protease units (SAPU), of preparations derived from, e.g., *Aspergillus niger*, and *Aspergillus oryzae*. The test is based on a 30-min enzymatic hydrolysis of a Hammarsten Casein Substrate at pH 3.0 and 37 °C. Unhydrolyzed substrate is precipitated with trichloroacetic acid and removed by filtration. The quantity of solubilized casein in the filtrate is determined spectrophotometrically (reference: Food Chemical Codex).

4. REAGENTS AND SOLUTIONS

4.1. Casein: Use Hammarsten-grade casein, (CAS 9000-71-9, e.g. Merck article number 102242)

4.2. Glycine-Hydrochloric Acid Buffer (0.05 M): Dissolve 3.75 g of glycine in about 800 mL of water. Add 1 M hydrochloric acid until the solution is pH 3.0, determined with a pH meter. Quantitatively transfer the solution to a 1000-mL volumetric flask, dilute to volume with water, and mix.

4.3. TCA Solution: Dissolve 18.0 g of trichloroacetic acid and 11.45 g of anhydrous sodium acetate in about 800 mL of water and add 21.0 mL of glacial acetic acid. Quantitatively transfer the solution to a 1000-mL volumetric flask, dilute to volume with water, and mix.

4.4. Substrate Solution: Pipet 8 mL of 1 M hydrochloric acid into about 500 mL of water and disperse 7.0 g (moisture-free basis) of Casein (4.1) into this solution, using continuous agitation. Heat for 30 min in a boiling water bath, stirring occasionally, and cool to room temperature. Dissolve 3.75 g of glycine in the solution and adjust to pH 3.0 with 0.1 M hydrochloric acid, using a pH meter. Quantitatively transfer the solution to a 1000-mL volumetric flask, dilute to volume with water, and mix.

5. SAMPLE PREPARATION

- Weigh the enzyme preparation, quantitatively transfer it to a glass mortar, and triturate with Glycine-Hydrochloric Acid Buffer (4.2).

- Quantitatively transfer the mixture to an appropriately sized volumetric flask, dilute to volume with Glycine-Hydrochloric Acid Buffer (4.2), and mix.

The solution of the sample enzyme preparation must be prepared so that 2 mL of the final dilution gives a corrected absorbance of enzyme incubation filtrate at 275 nm (A , as defined in the Procedure) between 0.200 and 0.500.

6. PROCEDURE

- Pipet 10.0 mL of Substrate Solution (4.4) into each of a series of 25 x 150 mm test tubes, allowing at least two tubes for each sample, one for each enzyme blank, and one for a substrate blank.
- Stopper the tubes, and equilibrate them for 15 min in a water bath maintained at $37^{\circ}\text{C} \pm 0.1^{\circ}\text{C}$.
- At zero time, start the stopwatch, and rapidly pipet 2.0 mL of the Sample Preparation into the equilibrated substrate.
- Mix by swirling and replace the tubes in the water bath. (Note: The tubes must be stoppered during incubation).
- Add 2 mL of Glycine-Hydrochloric Acid Buffer (instead of the Sample Preparation) to the substrate blank.
- After exactly 30 min, add 10 mL of TCA Solution (4.3) to each enzyme incubation and to the substrate blank to stop the reaction. (Caution: Do not use mouth suction for the TCA Solution).
- In the following order, prepare an enzyme blank containing 10 mL of Substrate Solution, 10 mL of TCA Solution, and 2 mL of the Sample Preparation.
- Heat all tubes in the water bath for 30 min, allowing the precipitated protein to coagulate completely.
- At the end of the second heating period, cool the tubes in an ice bath for 5 min, and filter through Whatman No. 42 filter paper, or equivalent. The filtrates must be perfectly clear.
- Determine the absorbance of each filtrate in a 1-cm cell at 275 nm with a suitable spectrophotometer, against the substrate blank. Correct each absorbance by subtracting the absorbance of the respective enzyme blank.

6.1. Standard Curve

- Transfer 181.2 mg of L-tyrosine, chromatographic-grade or equivalent (CAS 60-18-4, e.g. Merck article number 108371), previously dried to constant weight, to a 1,000-mL volumetric flask.
- Dissolve in 60 mL of 0.1 M hydrochloric acid.
- When completely dissolved, dilute the solution to volume with water, and mix thoroughly. This solution contains 1.00 µmol of tyrosine in 1.0 mL.
- Prepare dilutions from this stock solution to contain 0.10, 0.20, 0.30, 0.40, and 0.50 µmol per mL.
- Determine the absorbance of each dilution in 1-cm cell at 275 nm, against a water blank.
- Prepare a plot of absorbance versus µmol of tyrosine per mL. A straight line must be obtained.

Determine the slope and intercept for use in the Calculation below. A value close to 1.38 should be obtained for the slope. The slope and intercept may be calculated by the least squares method as follows:

$$\text{Slope} = [n\Sigma(MA) - \Sigma(M)\Sigma(A)] / [n\Sigma(M^2) - (\Sigma M)^2]$$

$$\text{Intercept} = [\Sigma(A)\Sigma(M^2) - \Sigma(M)\Sigma(MA)] / [n\Sigma(M^2) - (\Sigma M)^2]$$

in which n is the number of points on the standard curve, M is the µmol of tyrosine per ml for each point on the standard curve, and A is the absorbance of the sample.

6.2. Calculation

One spectrophotometric acid protease unit is that activity that will liberate 1 µmol of tyrosine per min under the conditions specified. The activity is expressed as follows:

$$\text{SAPU/g} = (\mathbf{A} - \mathbf{I}) \times \mathbf{22} / (\mathbf{S} \times \mathbf{30} \times \mathbf{W})$$

in which

A is the corrected absorbance of the enzyme incubation filtrate;

I is the intercept of the Standard Curve;

22 is the final volume of the incubation mixture, in mL;

S is the slope of Standard Curve;

30 is the incubation time, in min; and

W is the weight, in g, of the enzyme sample contained in the 2.0-mL aliquot of sample preparation added to the incubation mixture in the Procedure.

Appendix I: SDS-PAGE protein assay**1. PRINCIPLE**

This test is based on a modified Bradford method (Marchal et al., 1997; Marchal et al., 1996) combined with SDS-PAGE electrophoresis.

The quantification of proteins is realized with a Bradford test using an ultrafiltration at 3kDa to reduce the interferences due to ethanol and phenolic compounds (Marchal et al., 1996), and SDS-PAGE (Sodium Dodecyl Sulfate - PolyAcrylamide Gel) electrophoresis to separate the proteins according to their molecular weight (Laemmli, 1970).

2. PROTOCOL

- The samples (wines before treatment, wines with Aspergillopepsin I just added, wines after treatment) are ultrafiltrated with centrifuge filters 3 kDa (for example: Amicon® Ultra-4, Merck Millipore, Irlande) at 4500 g during 20 minutes at 18 °C, and the ultrafiltrate is collected.
- 400 µL ultrapure water are added to 400 µL of sample (wine or ultrafiltrate) and 200 µL Bradford reagent (Bio-Rad, USA) in a semi micro-cuvette (path length 10mm).
- The solution is mixed twice, and the absorbance is measured at 595 nm after 30 minutes, compared to ultrapure water.

To obtain the absorbance of proteins (A_P), the absorbance of the ultrafiltrate (A_{UF}) has to be deduced from the absorbance of wine (A_W):

$$A_P = A_W - A_{UF}$$

A standard curve with 5 concentrations (from 0 to 20 mg/L) is made with BSA (Bovin Serum Albumin) with 10-minutes reaction. The total protein content is calculated in mg/L eq. BSA, with the average value of 3 different measures.

Polyacrylamide gels are used, at 4% for stacking and 13% for resolving (composition in **Table 1**).

Samples are mixed with Laemmli buffer 4X (3 volumes of samples + 1 volume of buffer; Bio-Rad, USA) and analyzed by SDS-PAGE. Markers from 10 to 250 kDa are used as standards: Precision Plus Protein TM Unstained Standards, Bio-Rad, USA. The analyses are made by triplicate.

Table 1. Composition of resolving and stacking gels (for 4 gels).

Composition	Resolving gel (13%)	Stacking gel (4%)
Ultrapure water	6.2 mL	4.88 mL
Bis-Acrylamide (30%)	8.6 mL	1.04 mL
Buffer Tris-HCl 1,5M pH 8.8	5.0 mL	-
Buffer Tris-HCl 0,5M pH 6,8	-	2.0 mL
Sodium dodecyl sulfate (SDS) 10%	0.2 mL	80 µL
Ammonium Persulfate (APS) 10%	100 µL	40 µL
Tetramethylethylenediamine (TEMED)	20 µL	8 µL

Gels are run on a vertical electrophoresis apparatus (for example: Mini-PROTEAN III; Bio-Rad, USA) at room temperature and stained with Coomassie blue R250.

After migration, gels are stained with silver nitrate at room temperature according Rabilloud (1994): see **Table 2**.

Table 2. Protocol for silver staining SDS-PAGE gels.

Step	Solution: final concentration	Time
Fixing	Ethanol 99%: 30% (v/v) Acetic acid: 10% (v/v)	Over night
Sensitization	Ethanol 99%: 20% (v/v) Potassium acetate: 0.5M Potassium tetrathionate: 3 g/L Glutaraldehyde 50%: 1% (v/v)	2 h 30 min (in the dark)
Washing	Ultrapure water	3 x 20 min
Staining	Silver nitrate: 2 g/L Formaldehyde 37%: 0.7 mL/L	30 min
Washing	Ultrapure water	15 sec
Development	Potassium carbonate: 30 g/L Formaldehyde 37%: 0.5 mL/L Sodium thiosulfate. 5H ₂ O 2.48 g/L: 3.75 mL/L	5 min
Stop	Tris: 50 g/L Acetic acid: 25 mL/L	5 min

3. RESULTS

The molecular weight of chitinases and TLP (Thaumatococcus Like Proteins) is below 15 kDa and the proteases' one is close to 40 kDa. A visual analysis of the gels allows an initial observation of the residual proteins.

Precise results are obtained after digitalization of the SDS-PAGE gels and analysis with a specific software.

4. REFERENCES

- Marchal R., Seguin V. et Maujean A. Quantification of interferences in the direct measurement of proteins in wines from the Champagne region using the Bradford method. *American Journal of Enology and Viticulture*, 1997, 48, 303-309.
- Marchal R., Bouquelet S. et Maujean A. Purification and partial biochemical characterization of glycoproteins in a Champenois Chardonnay wine. *Journal of Agricultural and Food Chemistry*, 1996, 44, 1716-1722.

**DETERMINATION OF PECTIN METHYLESTERASE ACTIVITY
IN ENZYMATIC PREPARATIONS**

**(Pectin Methyl-Esterase Activity) (PME)
(EC. 3.1.1.11 – CAS N° 9025-98-3)**

OENO 9/2008
OIV-OENO 363-2012

General specifications

These enzymes are usually present within an complex enzymatic preparation. Unless otherwise stipulated, the specifications must comply with the Œno resolution Oeno 365-2009 concerning the general specifications for enzymatic preparations included in the International Oenological Codex.

1. Origin

Reference is made to paragraph 5 "Source of enzyme and fermentation environment" of the general monography on Enzymatic preparation

The enzyme preparations containing such activity are produced by directed fermentations such as *Aspergillus niger*, *Aspergillus oryzae*, *Aspergillus sojae*, *Aspergillus Tubigensis*, *Aspergillus Awamori*, *Rhizopus oryzae* and *Trichoderma longibrachiatum (T.reesei)*

2. Scope /Applications

Reference is made to the International Code of Oenological Practices, OENO 11/04; 12/04; 13/04; 14/04 and 15/04.

These enzyme activities are used to support grape maceration and grape juice extraction as well as to help the clarification of musts and wines and finally to improve their filterability.

**Determination of Pectine methylesterase activity using
methanol dosage**

1. Principle

The enzyme activity of demethylation of the pectin results in the appearance of free carboxyl groups associated with the galacturonic acids making up the chains.

The pectin methyl-esterase activity is estimated by determination of the methanol according to the Klavons & Bennet method (1986). The alcohol oxidase of *Pichia pastoris* is specific to primary alcohols with a low molecular weight and catalyses the oxidation of the methanol into formaldehyde. 2,4-Pentanedione condenses exclusively with aldehydes of low molecular weight such as formaldehyde, forming a chromophore absorbing at 412 nm.

2. Equipment

- 4.1 water bath at 25°C
- 4.2 water bath at 30°C
- 4.3 water bath at 60°C
- 4.4 water bath at 100°C
- 4.5 100-ml cylindrical flask
- 4.6 stop-watch
- 4.7 disposable spectrophotometer cuvettes with a 1-cm optical path length, for measurement in the visible spectrum
- 4.8. 1-L graduated flask
- 4.9. 100-ml graduated flask
- 4.10. pH-meter
- 4.11 500-5000 µl precision syringe
- 4.12 100-1000 µl precision syringe
- 4.13 0-200 µl precision syringe
- 4.14 0-20 µl precision syringe
- 4.15 spectrophotometer
- 4.16 15-ml sealed glass screw-top test tubes
- 4.17 metal rack for 15 ml test tubes
- 4.18 Vortex-type mixer
- 4.19 magnetic stirrer

3. Reagents

- 5.1 citrus fruit pectin with a degree of esterification of 63-66%. (Pectins *ex-citrus*: Fluka, ref: 76280 as an example).
- 5.2 orange peel pectin esterase (Fluka; 20 U/mg, ref: 76286 as an example).
- 5.3 sodium acetate (CH₃COONa 99% pure - MW = 82g/mole)
- 5.4 acetic acid (CH₃COOH 96% pure - MW = 60 g/mole, density = 1.058)
- 5.5 alcohol oxydase of *Pichia Pastoris* (Sigma, 250 U; 0.2 ml, ref: A2404 as an example). One unit of alcohol oxydase oxidizes one µmole of methanol into formaldehyde per minute at pH 7.5 and at 25°C.
- 5.6 ammonium acetate (CH₃COONH₄, 99.5% pure - MW = 77.08g/mole)
- 5.7 pentane-2,4-dione (C₅H₈O₂ - MW = 100.12g/mole)
- 5.8. methanol (CH₂OH, Analytical Reagent grade - MW = 32g/mole)
- 5.9 potassium dihydrogen phosphate (KH₂PO₄, 99% pure - MW = 136.06 g/mole)
- 5.10 disodium hydrogen phosphate (Na₂HPO₄·2H₂O 98.5% pure - MW = 178.05 g/mole)
- 5.11 distilled water
- 5.12 commercial enzyme preparation to be analysed

4. Solutions

6.1 Sodium acetate buffer 50 mM, pH 4.5

This consists of 2 solutions, A and B.

6.1.1 Solution A: introduce 4.10 g of sodium acetate (5.3) into 1 liter of distilled water (5.11).

6.1.2 Solution B: introduce 2.8 ml of acetic acid (5.4) into 1 liter of distilled water (5.11). 6.1.3 Preparation of the sodium acetate buffer: mix 39.2% of solution A (6.1.1) + 60.8% of solution B (6.1.2),. Check that the pH equals 4.5 using a pH-meter (4.10). Maintain at 4°C

6.2 Citrus fruit pectin solution at 0.5% (p/v)

Introduce 0.5 g of citrus fruit pectin (5.1) into 100 ml of sodium acetate buffer (6.1) in a 100-ml graduated flask (4.9).

The solution must be prepared as needed.

6.3 Acetic acid solution 0.05 M

Introduce 0.283 5 ml of acetic acid (5.4) into 100 ml of distilled water (5.11), in a 100-ml graduated flask (4.8).

6.4 Ammonium acetate solution 2 M

Dissolve 15.4 g of ammonium acetate (5.6) in 100 ml of acetic acid (6.3), in a 100-ml graduated flask (4.9).

6.5 2,4-Pentanedione 0.02 M

Introduce 40.8 µl 2,4-pentanedione (5.7) into 20 ml of ammonium acetate solution (6.4). The solution must be prepared as needed.

6.6 Sodium phosphate buffer (0.25 M; pH 7.5)

This consists of solutions A and B.

6.6.1 Solution A: introduce 34.015 g of potassium dihydrogen phosphate (5.9) into 1 liter of distilled water (5.11).

6.6.2 Solution B: introduce 44.5125 g of disodium hydrogen phosphate (5.10) into 1 liter of distilled water (5.11).

6.6.3 Preparation of the sodium phosphate buffer: mix 16.25 % of solution A (6.6.1) + 83.75% of solution B (6.6.2) to obtain a pH of 7.5.

Check the pH using a pH-meter (4.10).

Maintain at 4°C, for a maximum of one week

6.7. Stock solution of methanol at 40 µg/ml

Introduce 5 µl of methanol (5.8) using a precision syringe (4.14) into 100 ml of sodium phosphate buffer (6.6) in a 100-ml graduated flask (4.9).

6.8 Alcohol oxydase at 1U/ml

Dilute alcohol oxydase of *Pichia pastoris* (5.5) in a phosphate buffer (6.6) in order to obtain a solution at 1U/ml. The solution must be prepared as needed.

5. Preparation of the standard solutions of methanol

The standard solutions are produced from 0 to 20 µg methanol as indicated in Table 1. They are made up from the stock solution of methanol (6.7.)

Table 1: standard solutions of methanol

Quantity of Methanol (µg)	0	5	10	15	20
Quantity of Methanol (µmole)	0	0.1563	0.3125	0.4688	0.625
Vol. stock solution (6.7.) (µl)	0	75	150	225	300
Vol. buffer (6.6.) (µl)	600	525	450	375	300

6. Preparation of the sample

It is important to homogenise the enzyme preparation before sampling, by upturning the container for example. The enzyme solution and the blanks have to be prepared at the time of use.

8.1 Enzyme solution with 1 g/l to be prepared just before use

Place 100 mg of commercial preparation (5.12) in a 100-ml graduated flask (4.9), make up to the mark with distilled water (5.11), and stir (4.19) in order to obtain a homogeneous mixture.

8.2. Blank denatured by heating to be prepared just before use

Place 10 ml of the enzyme solution at 1 g/l (8.1) in a 15-ml screw-top test tube (4.16), and immerse the test tube for 5 minutes in the water bath at 100°C (4.4). Cool and centrifuge for 5 min at 6500 g.

7. Procedure

9.1 Enzyme kinetics: The test tubes are prepared at least in duplicate.

In 5 x 15-ml test tubes (4.16) numbered from 1 to 5, placed in a rack (4.17) in a water bath at 30°C introduce:

100 µl of the enzyme solution at 1 g/l (8.1), using the precision syringe (4.13),

500 µl of the citrus fruit pectin solution (6.2) warmed beforehand at 30°C in a water bath, start the stop-watch (4.6).

After shaking (4.18), the test tubes are replaced in the water bath at 30°C (4.2):

for 1 min. for test tube N°1

for 2 min. for test tube N°2

for 5 min. for test tube N°3

for 10 min. for test tube N°4

for 15 min. for test tube N°5

The reaction is stopped by placing each of the test tubes numbered from 1 to 5, immediately after they have been removed from the water bath at 30°C, in the water bath at 100°C (4.3) for 10 min.

The test tubes are then cooled under running cold water.

Note: the kinetic point at 10 min is used for the evaluation of the enzyme activity

9.2 Determination of methanol released

In a 15-ml screw-top test tube (4.16)

Add 1 ml of the alcohol oxydase solution (6.8) to the reaction medium (9.1), using the precision syringe (4.12), start the stop-watch (4.6).

After shaking (4.18), the test tube is placed in the water bath at 25°C (4.1) for 15 min.

Then add 2 ml of 0.02 M 2,4-pentanedione (6.5) using the precision syringe (4.11), start the stop-watch (4.6).

After shaking (4.18), the test tube is placed in the water bath at 60°C (4.3) for 15 min.

The test tube is then cooled under running cold water.

Place the supernatant liquid in a cuvette (4.7).

Zero the spectrophotometer using distilled water.

Immediately measure the absorbance at 412 nm (4.15).

9.3 Blanks

Proceed as described in 9.1, replacing the enzyme solution at 1 g/l (8.1) by the blank denatured by heat (8.2). For each kinetic point, the enzymatic reaction of each blank is carried out at the same time as that of the enzyme solution.

9.4 Standard solutions

Proceed as described in 9.2, replacing the reaction mixture (9.1) by the various mixtures of the standard solutions of methanol from 0 to 20 µg (7).

8. Calculations**10.1 Determining the reaction kinetics**

In general, calculating the enzymatic activity can only be done when the substrate and the enzyme are not in limiting quantities. This therefore refers to the ascending phase of the kinetic curve: the enzymatic activity is linear in time. Otherwise, the activity would be underestimated (Figure 1).

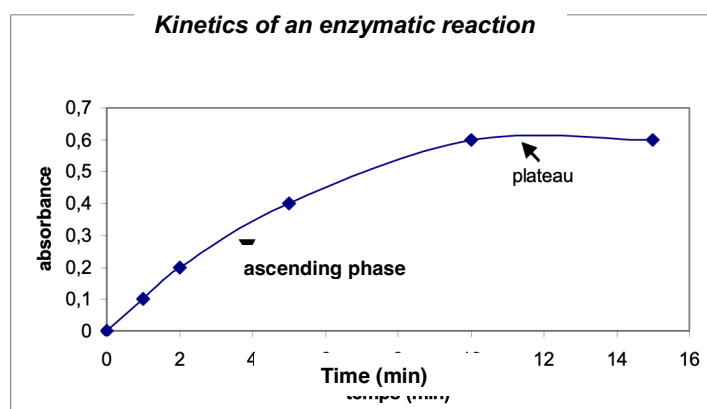

Figure 1: Kinetics of an enzymatic reaction

The kinetics are determined over 15 minutes. The activity concerned is measured at $T=1$ min, $T=2$ min, $T=5$ min, $T=10$ min, $T=15$ min.

After determining the kinetics of the enzymatic reaction, plot the curve for the variation in absorbance in relation to reaction time. The absorbance corresponds to the difference between the absorbance at time T of the enzyme preparation and that of the corresponding blank. Then calculate the equation (1) of the straight regression line, taking into account only the points of the ascending phase (see figure 1).

10.2 Producing the calibration line

The calibration line corresponds to plotting a graph whose X-coordinates are the various concentrations of the standard solutions of methanol (from 0 to $0.625 \mu\text{mole}$) and whose Y-coordinates are the corresponding values of optical densities, obtained in 9.4. Then calculate the straight regression line (2) resulting from the linearity of the data of the graph.

10.3 Calculating the enzymatic activity

Based on the straight regression line (1) calculate the absorbance for an average time T (for example 4 min. in the case of figure 1) deduct from it the quantity Q of methanol released (in μmoles) for this intermediate time using equation (2).

The formula used to calculate the enzymatic activity in U/g of the preparation is as follows

$$\text{Activity in U/g} = 1000 \times (Q/T)/(V \times C)$$

Where Q: quantity of methanol released in μmoles during time T (min)
 V: quantity of enzyme solution introduced (ml), in this case 0.1 ml
 C: concentration of the enzyme solution (g/l), in this case 1 g/l

It is then possible to express the enzymatic activity in nanokatal. This unit corresponds to the number of nanomoles of product formed per second under the conditions defined by the determination protocols and therefore:

$$\text{Activity in nkat/g} = (\text{activity in U/g}) \times (1000/60)$$

11. Characteristics of the method

r	0.14
R	0.112
Sr	0.05
SR	0.04

The intralaboratory repeatability of the method is estimated using the mean standard deviation of the absorbance values resulting from the same sampling of the enzymatic preparation, determined 5 times. In this way, for the pectin-methyl-esterase determination the mean standard deviation of the values is 0.05 with a percentage error of 5.46, in which the % error corresponds to:

$$\frac{(\text{mean standard deviation of values} \times 100)}{\text{mean test value}}$$

In this way, the method of determination as presented is considered repeatable.

The **intralaboratory** reproducibility tests were carried out using 2 enzymatic preparations with 5 samplings for each.

2 tests were used in order to determine the satisfactory reproducibility of the method:

- analysis of variance (the study of the probability of the occurrence of differences between samplings). Analysis of variance is a statistical method used to test the homogeneity hypothesis of a series of K averages. Performing the analysis of variance consists in determining if the "treatment" effect is "significant or not". The standard deviation of reproducibility given by this analysis of variance is 0.04.
- the power of the test for the first type of risk α (5%) – first type of risk α is the risk of deciding that identical treatments are in fact different.

If the power is low ($\cong 20\%$), this means that no difference has been detected between treatments, but there is little chance of seeing a difference if one did in fact exist.

If the power is high ($\cong 80\%$), this means that no difference has been detected between the treatments, but, if there was one, we have the means of seeing it.

The results are given in table 2.

Determination	Analysis of variance hypotheses	Probability	Power of test ($\alpha= 5\%$)	Newman-Keuls test (*)	Bonferroni test (**)
PME	Adhered to	0.00001	99%	Significant	Significant

Table 2: analysis of variance– study of the sampling effect

* Newmann-Keuls test: this comparison test of means is used to constitute homogeneous groups of treatments: those belonging to the same group are regarded as not being different to risk α of the first species selected

** Bonferroni test: also referred to as the "corrected T test", the Bonferroni test is used to carry out all the comparisons of pairs of means, i.e., $(t - t_1)/2$ comparisons before treatments, respecting the risk α of the first species selected.

In this way, the tests set up are used to see a difference if there really is one (high power test); in addition, the method of determination involves a probability of occurrence of a discrepancy in activity (between samplings) lower than 5%.

12. Bibliographical references

KLAVONS J.A., BENNET R.D., Determination of methanol using alcohol oxydase and its application to methyl ester content of pectins. J. Agr. Food. Chem, 1986. Vol 34, p 597-599.

Enzyme activities and their measurement – OIV Document, FV 1226, 2005

Determination of Pectinmethylesterase activity using acid based titration**1. Principle**

The demethylation activity of the pectinmethylesterase results in the appearance of free carboxylic groups at the level of the galacturonic acids forming the chains. To determine the activity of pectinmethylesterase, the carboxyl groups can be titrated during the enzymatic hydrolysis with sodium hydroxide solution at constant temperature and constant pH-value.

2. Equipment and materials

- titration equipment (burette)
- temperature controlled heat plate and magnetic stirrer/magnetic stir bar
- pH meter
- glass cup, filled with water
- chronometer
- graduated flasks (different volume)
- beakers (preferably 50 mL)
- precision pipettes (different volume)

3. Chemicals and reagents

- Pectin; highly esterified; p.a. quality (Sigma P9135-100G); CAS 9000-69-5
- 0,01 M NaOH solution (Titrisol) p.a. quality; CAS 1310-73-2
- NaOH pellets p.a. quality ; CAS 1310-73-2

4. Preparation of solutions**4.1. 1 M NaOH**

Dissolve 4 g NaOH in 100 mL H₂O

4.2. substrate solution

As substrate solution 1 % Pectin in H₂O, is used by solving 2.0 g Pectin very slowly in 150 ml H₂O. Subsequently the pH value is adjusted at pH 4.0 and at 40 °C with 1 M NaOH. The solution must be filled up to 200 mL exactly. Just before measuring, the pH-value should be controlled and adjusted again at pH 4,0, if necessary

4.3. enzymatic solution

The enzymatic solution consists of approximately 30 to 50 mg/L commercial enzyme preparation diluted in cold water. This solution should be prepared directly before using.

4.4. 0.01M NaOH

This precast solution should be diluted according to the description of the producer.

5. Performance of enzyme activity determination

20 ml of substrate solution are put in a beaker (magnetic stirrer is added) on the temperature controlled heat plate in a glass cup, which is filled with water heated up to 40 °C. The pH electrode is put in substrate solution. It is necessary to have a control and maybe a new setting up of the pH-value at 40 °C before starting the analysis. Then 0.1 ml of the enzymatic solution is added. Exactly at this time the chronometer is started. During the analysis the pH value must be measured and the sample has to be titrated up to pH 4.0 with 0.01 M NaOH for 10 minutes at 40 °C. After 10 min the analysis is stopped and the consumption of 0.01 M NaOH is read off.

The consumption of 0,01 M NaOH should amount to values between 3,5 mL and 8,5 mL. Otherwise it is recommended to dilute or concentrate the enzymatic solution.

6. Calculation of the enzymatic activity

Enzymatic activity is calculated by using following formula:

$$\text{Activity (U/mg)} = n / (t*v*c)$$
$$\text{Activity (nkat/g)} = (\text{Activity (U/mg)} * 1000/60) * 1000$$

n = consumption of 0.01 M NaOH in µmol

t = time in min (in this case 10 min)

v = quantity of enzymatic solution introduced in ml (=0.1 ml)

c = concentration of the enzymatic solution in g/L

Validation of the acid based titration to determine the activity of Pectin methylesterase

The mean value of the standard deviation was determined of 8 different enzymes.

INTERNATIONAL ŒNOLOGICAL CODEX

Pectin Methyl Esterase

COEI-1-ACTPME: 2012

Each enzyme was analysed 6 times.

Mean value of the standard deviations of the different enzymes = 3.91 %

	Enzyme 1 40 mg/ml	Enzyme 2 40 mg/ml	Enzyme 3 40 mg/ml	Enzyme 4 40 mg/ml	Enzyme 5 40 mg/ml	Enzyme 6 40 mg/ml	Enzyme 7 30 mg/ml	Enzyme 8 50 mg/ml	Enzyme 8 30 mg/ml
Mean Value (nkat/g)	14527.7	19291.7	12756.8	9534.7	9444.5	18577.8	31591.7	10888.9	9446.5
Standard Deviation (nkat/g)	282.3	449.5	366.4	227.4	272.3	145.6	540.9	944.4	1096.1
Standard Deviation %	1.9	2.3	2.9	2.4	2.9	0.8	1.7	8.7	11.6
s ² (r)	66410	168402	111863	43097	61786	17654	243773	743210	1001244
s (r)	257.7	410.4	334.5	207.6	248.6	132.9	493.7	862.1	1000.6
Repeatability r (nkat/g)	729.3	1161.3	946.5	581.5	703.4	376.0	1397.3	2439.7	2831.8

Validation of the acid based titration to determine the activity of PME

Enzyme	Concentration	U/mg	nkat/g	Enzyme 1 40 mg/ml		(X-MW) ²
Enzyme 1	40 mg/ml	0.89	14833	mean value (nkat/g)	14527.7	93228.4
Enzyme 1	40 mg/ml	0.89	14750	standard deviation (nkat/g)	282.30	49432.1
Enzyme 1	40 mg/ml	0.88	14667	standard deviation %	1.9	19413.8
Enzyme 1	40 mg/ml	0.85	14083	variance	3.8	197728.4
Enzyme 1	40 mg/ml	0.87	14500	s ² (r)	66410.6	765.4
Enzyme 1	40 mg/ml	0.86	14333	s (r)	257.7	37895.1
				r (nkat/g) repeatability	729.3	sum 398463.3

INTERNATIONAL OENOLOGICAL CODEX

Pectin Methyl Esterase

COEI-1-ACTPME: 2012

Enzyme	Concentration	U/mg	nkat/g	Enzyme 2 40 mg/ml		(X-MW) ²
Enzyme 2	40 mg/ml	1.185	19750	mean value (nkat/g)	19291.7	210069.4
Enzyme 2	40 mg/ml	1.155	19250	standard deviation (nkat/g)	449.54	1736.1
Enzyme 2	40 mg/ml	1.130	18833	standard deviation %	2.3	210069.4
Enzyme 2	40 mg/ml	1.125	18750	s ² (r)	168402.8	293402.8
Enzyme 2	40 mg/ml	1.190	19833	s(r)	410.4	293402.8
Enzyme 2	40 mg/ml	1.160	19333	r (nkat/g) repeatability	1161.3	1736.1
				sum		1010416.7

Enzyme	Concentration	U/mg	nkat/g	Enzyme 3 40 mg/ml		(X-MW) ²
Enzyme 3	40 mg/ml	0.78	13042	mean value (nkat/g)	12756.8	81320.0
Enzyme 3	40 mg/ml	0.79	13208	standard deviation (nkat/g)	366.38	203551.4
Enzyme 3	40 mg/ml	0.76	12708	standard deviation %	2.9	2384.7
Enzyme 3	40 mg/ml	0.76	12583	s ² (r)	111863.1	30218.0
Enzyme 3	40 mg/ml	0.77	12833	s(r)	334.5	5801.4
Enzyme 3	40 mg/ml	0.73	12167	r (nkat/g) repeatability	946.5	347903.4
				sum		671178.8

INTERNATIONAL OENOLOGICAL CODEX

Pectin Methyl Esterase

COEI-1-ACTPME: 2012

Enzyme	Concentration	U/mg	nkat/g	Enzyme 4 40 mg/ml		(X-MW) ²
Enzyme 4	40 mg/ml	0.57	9500	mean value (nkat/g)	9534.67	1201.8
Enzyme 4	40 mg/ml	0.59	9875	standard deviation (nkat/g)	227.41	115826.8
Enzyme 4	40 mg/ml	0.56	9333	standard deviation %	2.4	40669.4
Enzyme 4	40 mg/ml	0.56	9250	s ² (r)	43096.9	81035.1
Enzyme 4	40 mg/ml	0.58	9583	s(r)	207.6	2336.1
Enzyme 4	40 mg/ml	0.58	9667	r (nkat/g) repeatability	587.5	17512.1
sum						258581.3

Enzyme	Concentration	U/mg	nkat/g	Enzyme 5 40 mg/ml		(X-MW) ²
Enzyme 5	40 mg/ml	0.55	9167	mean value (nkat/g)	9444.5	77006.3
Enzyme 5	40 mg/ml	0.59	9792	standard deviation (nkat/g)	272.29	120756.3
Enzyme 5	40 mg/ml	0.55	9083	standard deviation %	2.9	130682.3
Enzyme 5	40 mg/ml	0.57	9458	s ² (r)	61785.6	182.3
Enzyme 5	40 mg/ml	0.57	9542	s(r)	248.6	9506.3
Enzyme 5	40 mg/ml	0.58	9625	r (nkat/g) repeatability	703.4	32580.3
sum						370713.5

Enzyme	Concentration	U/mg	nkat/g	Enzyme 6 40 mg/ml		(X-MW) ²
Enzyme 6	40 mg/ml	1.105	18417	mean value (nkat/g)	18577.8	25956.8
Enzyme 6	40 mg/ml	1.118	18633	standard deviation (nkat/g)	145.55	3086.4
Enzyme 6	40 mg/ml	1.125	18750	standard deviation %	0.8	29660.5
Enzyme 6	40 mg/ml	1.105	18417	s ² (r)	17654.3	25956.8
Enzyme 6	40 mg/ml	1.112	18533	s(r)	132.9	1975.3
Enzyme 6	40 mg/ml	1.123	18717	r (nkat/g) repeatability	376.0	19290.1
sum						105925.9

INTERNATIONAL OENOLOGICAL CODEX

Pectin Methyl Esterase

COEI-1-ACTPME: 2012

Enzyme	Concentration	U/mg	nkat/g	Enzyme 7 30 mg/ml		(X-MW) ²
Enzyme 7	30 mg/ml	1.920	32000	mean value (nkat/g)	31591.7	166736.1
Enzyme 7	30 mg/ml	1.947	32450	standard deviation (nkat/g)	540.86	736736.1
Enzyme 7	30 mg/ml	1.873	31217	standard deviation %	1.7	140625.0
Enzyme 7	30 mg/ml	1.860	31000	s ² (r)	243773.1	350069.4
Enzyme 7	30 mg/ml	1.893	31550	s(r)	493.7	1736.1
Enzyme 7	30 mg/ml	1.880	31333	r (nkat/g) repeatability	1397.3	66736.1
sum						1462638.9

Enzyme	Concentration	U/mg	nkat/g	Enzyme 8 50 mg/ml		(X-MW) ²
Enzyme 8	50 mg/ml	0.578	9633	mean value (nkat/g)	10888.9	1576419.8
Enzyme 8	50 mg/ml	0.682	11367	standard deviation (nkat/g)	944.38	228271.6
Enzyme 8	50 mg/ml	0.706	11767	standard deviation %	8.7	770493.8
Enzyme 8	50 mg/ml	0.712	11867	s ² (r)	743209.9	956049.4
Enzyme 8	50 mg/ml	0.596	9933	s(r)	862.1	913086.4
Enzyme 8	50 mg/ml	0.646	10767	r (nkat/g) repeatability	2439.7	14938.3
sum						4459259.3

INTERNATIONAL OENOLOGICAL CODEX

Pectin Methyl Esterase

COEI-1-ACTPME: 2012

Enzyme	Concentration	U/mg	nkat/g	Enzyme 8 30 mg/ml		(X-MW) ²	
Enzyme 8	30 mg/ml	0.69	11444	mean value (nkat/g)	9446.5	3990006.3	
Enzyme 8	30 mg/ml	0.067	8667	standard deviation (nkat/g)	1096.13	607620.3	
Enzyme 8	30 mg/ml	0.063	8889	standard deviation %	11.6	310806.3	
Enzyme 8	30 mg/ml	0.065	8429	s ² (r)	1001243.9	1035306.3	
Enzyme 8	30 mg/ml	0.07	9625	s(r)	1000.6	31862.3	
Enzyme 8	30 mg/ml	0.067	9625	r (nkat/g) repeatability	2831.8	31862.3	
						sum	6007463.5

mean value of the standard deviations %	3.91
--	-------------

UREASE
E.C. 3.5.1.5.
CAS N°: 9002-13-5
OENO 5/2005

GENERAL SPECIFICATIONS

The specifications must be in compliance with general specifications for enzymatic preparations as provided for in the International Oenological Codex.

1. OBJECT, ORIGIN AND FIELD OF APPLICATION

The purpose of an enzyme is to break down urea into ammonia and carbon dioxide. Urease is produced from *Lactobacillus fermentum*. It belongs to the urease group collectively called "urease acids". They are activated at low pH levels.

L. fermentum is grown in a synthetic environment. After fermentation, the culture is filtered, washed in water and the cells are killed in 50% vol alcohol. The suspension is freeze dried or dried by pulverisation.

The preparation consists of a powder made up of whole dead cells containing enzymes.

Urease contains no substances, nor micro-organisms nor collateral enzymatic activities which are:

- harmful to health,
- harmful to the products treated,
- lead to the formation of undesirable products,
- produces or facilitates fraud

2. LABELING

The concentration of the product must be indicated on the label in addition to security and storage conditions and the to the expiration date.

3. ENZYMATIC ACTIVITY

The claimed enzymatic specific activity is posted at 3.5 U/mg. Note that one unit is defined as the quantity of enzymes which release one micromole molecule of ammonia hydroxide from 5 g/l dose of urea, per minute at pH level 4 in a citrate buffer 0.1 M medium, at 37 °C.

This activity is the only isolation.

4. CHARACTERISTICS

Urease can be found in the crystal powder form, white, odourless, with a mild taste

5. SUPPORTS, DILUENTS, PRESERVATION AGENT

The only substance added for conditioning is dextrin.

6. TRIALS**6.1 Sulphuric ashes**

Determine sulphuric ashes according to the method in Chapter II in the International Oenological Codex. The rate of sulphuric ashes in urease must not be over 8%.

6.2 Solution for trials:

Dissolve 5 g of urease in 100 ml of water.

6.3 Heavy metals

A 10 ml of solution for trials (6.2), add 2 ml of buffer solution pH 3.5 (R), 1.2 ml of thioacetamide (R) reagent. There should be no precipitation. If brown colouring occurs, it should be less than demonstrated in the trial prepared as indicated in Chapter II of the International Oenological Codex.

The contents of heavy metals expressed in lead, must be less than 30 mg/kg.

6.4 Arsenic

Measure arsenic according to the method which appears in Chapter II of the International Oenological Codex from the trial solution (6.2).

The contents of arsenic must be less than 2 mg/kg.

6.5 Lead

Measure lead according to the method which appears in Chapter II of the International Oenological Codex from the trial solution (6.2).

The contents of lead must be less than 5 mg/kg.

6.6 Mercury

Measure mercury according to the method which appears in Chapter II of the International Oenological Codex from the trial solution (6.2).

The contents of mercury must be less than 0.5 mg/kg.

6.7 Cadmium

Measure cadmium according to the method which appears in Chapter II of the International Oenological Codex from the trial solution (6.2).
The contents of cadmium must be less than 0.5 mg/kg.

7. BIOLOGICAL CONTAMINANTS

Carry out a counting according the method described in Chapter II of the International Oenological Codex

- | | |
|-----------------------------|---------------------------------|
| 7.1 Total bacteria | under 5×10^4 CFU/g |
| 7.2 Coliformesteneur | under 30 CFU/g of preparation |
| 7.3 <i>Escherichia coli</i> | absence checked on 25 g sample |
| 7.4 <i>St. aureus</i> | absence checked on 1 g sample |
| 7.5 Salmonella | absence checked on 25 g sample. |

No mutagenic or bacterial activity should be detectable

It is also admitted that no *Lactobacillus* strain should produce antibiotics.

8. APPLICATION TO WINE

Urease must be carefully incorporated and mixed in wine to be aged more than 1 year if it contains more than 3 mg/l of urea. The dose to be used will be 25 mg/l to 75 mg/l, according to tests carried out beforehand. This procedure is carried out in less than 4 weeks at a temperature above 15°C and when there is less than 1 mg/l fluoride ions.

- After a noticeable decrease in urea, for example less than 1 mg/l, all enzymatic activity is eliminated by filtering the wine. (diameter of pores under 1 µm).

9. STORAGE CONDITIONS

Urease can be stored for several months at a low temperature (+ 5 °C). There is a 50% loss in activity annually.

FISH GLUE
Isinglass
OENO 24/2000

1. OBJECTIVE, ORIGIN AND SCOPE OF APPLICATION

Fish glue is made from the swim bladder, gills and ears of certain fish, notably sturgeon.

It is produced in the form of colorless or slightly yellowish transparent sheets or, most frequently, in ribbons which have the appearance of dry parchment, or in vermiculated or powder form.

Fish glue expands in cold water and becomes opaque. It dissolves in hot water acidified with tartaric acid, leaving at most 3 pp 100 of residue composed of membranes. With 30-50 parts of hot water and after cooling, it forms a colorless, translucent jelly.

After partial hydrolysis, fish glue is often found in ready-to-use colloidal solution form stabilized by SO₂. In this case, it should be stored cool in a closed container.

Fish glue is used to clarify white and rose wines.

2. LABELING

The label should indicate product concentration, even when used in mixtures, as well as its safety and storage conditions. The expiration date and the SO₂ content should be indicated on the label.

3. TESTS

3.1. A hot water solution should be odorless and have no disagreeable taste. Reaction should be neutral or slightly alkaline. It precipitates with tannin.

Fish glue pH ranges between 3.5 and 4 when tartaric acid has been used to facilitate dissolution.

3.2. Fish glue processed with a potassium hydroxide solution (R) should remain transparent and, after several hours, yield a colorless liquid which will produce a light, frothy precipitate over time. Under the same conditions, the gelatin becomes opaque and difficult to make soluble. It produces an abundant, white precipitate.

3.3. Test for albuminoid substances. Aqueous solutions should not form a precipitate when iron (III) sulfate solution (R) is added.

3.4. Desiccation Loss

3.4.1 *Fish Glue in Solid Form*

In a silica dish with cover and measuring 70 mm in diameter, place 2g fish glue. Oven dry at 100-105° for six hours. Allow to cool in the uncovered dish in a desiccator. Weigh. Let **p** be the quantity of dry residue. Weight loss should not exceed 18 pp 100.

3.4.2 *Fish Glue in a Liquid State*

In a silica dish 70 mm in diameter place approximately 10 g fish glue colloidal solution, weight this amount with precision in the uncovered dish, dry in a water bath at 100° C for 4 hours and complete the drying process in the oven at 100-105° C for 3 hours. Allow to cool in the uncovered dish in the drying apparatus. Weigh the dry residue produced. Let **p** be the quantity added to 100 g colloidal solution. The dry residue should reach a minimum level of 1 pp 100.

All of the limiting values set forth above are stipulated for the dry product.

3.5. Ash

Burn the dry residue in test 3.4 by gradually heating to 600° in a muffle furnace after dusting the fish glue with 0.1 to 0.3 g paraffin without ash, in order to prevent the mass of material from overflowing. Ash content should be less than 2 pp 100.

3.6. Preparation of Test Solution

After eighing, dissolve the ash in 2 ml concentrated hydrochloric acid (R) and 10 ml water. Heat to stimulate dissolution and add distilled water until a volume equal to 25 times the weight of the dry fish glue is obtained. 1 ml of this solution contains the mineral substances derived from 0.04 g dry fish glue.

3.7. Total Nitrogen

Refer to the technique described in the Annex.

Total nitrogen content should be greater than 14 pp 100.

3.8. Iron

1 ml concentrated hydrochloric acid (R), one drop potassium permangante in concentration of 1 pp 100 (R) and 2 ml potassium thiocyanate in a concentration of 5 pp 100 (R) are added to 10 ml of the test solution prepared according to Par. 3.6).

If a red coloring appears, it must be less intense that that of a control prepared from 4.2 ml of iron (III) solution in a concentration of

0.010 g per liter, 5.8 ml water, and the same quantities of concentrated hydrochloric acid (R) and of potassium thiocyanate in a concentration of 5 pp 100.

Iron content should be less than 100 mg/kg.

The quantitative analysis of iron can also be implemented by atomic absorption spectrometry, using the technique reported in the Compendium.

3.9. Arsenic

Using the method described in the Annex, determine the arsenic content in the test solution prepared according to Par. 3.6. Arsenic content should be less than 3 mg/kg..

3.10. Lead

Using the method described in the Compendium, determine the lead content in the test solution prepared according to Par. 3.6. (Lead content should be less than 5 mg/kg).

3.11. Mercury

Using the method described in the annex, quantify the mercury content in the test solution prepared according to Par. 3.6. (Mercury content should be less than 1 mg/kg).

4. STORAGE

Fish glue should be stored in hermetic flasks. An expiration date should be specified.

Store colloidal solutions at temperatures of less than 10 °C to avoid rapid hydrolysis of the product during storage.

DEPTH FILTER SHEETS

OIV-OENO 629-2021

1. OBJECTIVE, ORIGIN AND SCOPE OF APPLICATION

Depth filter sheets, belonging to the family of porous filter materials, are composed of organic and/or inorganic materials, and are generally used for clarification and/or microbiological stabilisation of liquids; their geometrical shapes are specific to the filtration systems defined by the manufacturers.

2. PRINCIPLE

Filtration with depth filter sheets is a physical separation process that is applied to particles ranging from 0.1 to 40 µm, allowing for the retention of bacteria, yeasts, other microorganisms and particles. The retention of the particles is based on a process of interception and adsorption within the depth filter sheets (trap deep within the sheet), and to a lesser extent a sieve effect at the outer surface, while the fluid passes through the sheets under the action of a pressure gradient. Depth filter sheets are characterised by their permeability and retention rate, which allow for different types of filtration: coarse, clarifying, or sterilising.

The treatment of musts and wines by filtration is described in the OIV *International Code of Oenological Practices*.

Filtration with depth filter sheets is carried out with filter apparatus and/or lenticular module housings and a feeding pump. Normally the filtration process is ended when a differential pressure of 300 kPa (3 bar) is reached. For filtration performance reasons, a differential pressure of 150 kPa (1.5 bar) should not be exceeded in applications for separating microorganisms, which should be conducted under constant flow conditions.

3. COMPOSITION

Depth filter sheets are manufactured using raw materials specially selected for purpose, such as purified, bleached and finely fibrillated cellulose fibres from deciduous and coniferous trees, as well as different quantities of organic and inorganic filter aids like diatomaceous earth, perlite, zeolites, silicates, PVPP, synthetic wood pulp, activated carbon and/or other OIV-reviewed compounds. Polyamidoamine polymers are used as wet strength agents to improve the tensile properties in both wet and dry states, by crosslinking the cellulose fibres with covalent bonds that do not break upon wetting. The wet strength agent content should not exceed 4% of the dry fibres in the finished product. The main components and their monographs are listed in the OIV *International Oenological Codex*. Wet strength agents are approved for usage in hot- and cold-water filter

papers¹.

4. LABELLING

The main product characteristics such as filter grade, size and batch number should be indicated on the label.

5. MANUFACTURE

A slurry of the above-mentioned compounds is dewatered on a wire belt with vacuum, and afterwards dried in an oven.

Through a number of procedures (refining/grinding/fibrillating) performed on the cellulose and the use of different inorganic filter aids, it is possible to obtain a whole range of permeabilities and retention rates (from 0.1 to 40 µm).

The depth filter sheets' final characteristics (thickness, porosity, pore size, flow rate, microorganism reduction, adsorption) depend on a great number of parameters (choice of cellulose fibres from deciduous and/or coniferous trees, amount and type of inorganic material, dewatering, temperature, etc.).

Depth filter sheets can be produced in any geometrical shape using die cutting or water jet cutting and used as flat sheets, or in lenticular filter modules, capsules or other products.

6. DEPTH FILTER SHEET RINSING AND STERILISATION

Depth filter sheets should be flushed with water before the first filtration, according to the manufacturer's instructions. After rinsing, the rinse water should be disposed of according to the local regulations in force. Depth filter sheets can be sterilised with hot water (85 °C) or inline steam (125 °C to max. 134 °C). In both cases, rinsing should be carried out for at least 20 minutes.

7. REGENERATION / BACKWASHING

When the maximum differential pressure is reached, a regeneration of the filter sheets can be performed. Depending on the nature of the blocking particles, it may be possible to extend the life of the filter with this procedure.

To regenerate the filter sheets, rinse them with cold water (15-20 °C) in the direction of filtration flow for approx. 5 minutes, then rinse with hot water (60-80°C) in the opposite direction of filtration flow for approx. 10 minutes. It is not recommended to perform more than 5 regeneration cycles per filter sheet. It is however recommended, for bacteriological safety reasons, to replace filter sheets

¹ According to the respective recommendations and standards of the BfR (Germany) and FDA (United States), the GB 9685 standard, and other codes relating to foodstuffs, common consumption products and animal feed.

no more than 4 weeks after their first use.

8. DISPOSAL

Local waste-sorting guidelines should be complied with when disposing of depth filter sheets. In principle, used filter sheets are biodegradable². Ensuring the local regulations in force are followed, these can be disposed of as normal domestic waste for landfill or destroyed by thermal processes. This is provided that the depth filter sheets have not come into contact with any toxic substances during the filtration process. This statement is also applicable for depth filter sheets used in lenticular filter modules or other systems.

9. TESTS

All of the equipment (depth filter sheets, lenticular filter modules, or other parts and products of the filter system) in contact with food products must comply with the following limits.

There should be no noticeable change in the sensory (organoleptic) characteristics of the musts and wines if the depth filter sheets are used and handled according to the recommendations of the manufacturer.

The limits are determined according to values observed from use of depth filter sheets made in accordance with good manufacturing practices.

9.1 Dry matter content in an aqueous extract

The products can be used as hot- and cold-water filter papers and filter layers for foodstuffs.

Determine the dry matter, after pre-flushing the depth filter sheet with a volume of 50 L/m² before extraction, according to the following standards:

- the total quantity of extractables (hot water)^{3 4} should be less than 10 mg/g,
- the total quantity of extractables (cold water)^{5 3} should be less than 5 mg/g,
- the total quantity of all organic extractables^{4 3} should be less than 2 mg/g.

9.2 Chloropropanol content

The 1,3-dichloro-propan-2-ol (DCP) and 3-monochloropropane-1,2-diol (MCPD) content is determined in the cold/hot water extract after pre-flushing the depth filter sheet with a volume of 50 L/m² ^{2 4}.

The quantification of DCP and MCPD⁶ is performed after:

² According to standard EN 13432:2000 (composting and biodegradation).

³ According to standard EN 647:1993 (hot water extract).

⁴ According to standard EN 920:2000 (determination of dry matter content in an aqueous extract).

⁵ According to standard EN 645:1993 (cold water extract).

the separation of the analytes in the water extract using a solid-phase extraction column. The DCP and MCPD are derivatised using heptafluorobutyrylimidazole (HFBI) and determined by GC-ECD chromatography.

9.2.1 1,3-Dichloro-propan-2-ol (DCP) content

- Proceed with determination as in point 9.2,
- the 1,3-dichloro-propan-2-ol (DCP) content must be lower than 2 µg/L in a cold/hot water extract.

9.2.2 3-Monochloropropane-1,2-diol (MCPD) content

- Proceed with determination as in point 9.2,
- the 3-monochloropropane-1,2,-diol (MCPD) content must be lower than 12 µg/L in a cold/hot water extract.

9.3 Soluble metal and heavy metal content

The soluble metal content, as for that of heavy metals, is always determined in the extract after pre-flushing the depth filter sheet with a volume of 50 L/m². For extraction, acetic acid is used at 5% (p.a.).

Extraction procedure:

- place the filter holder horizontally, and for better ventilation, position the filter bottom-up,
- volumetric flow rate: $V = (500 \pm 50) \text{ L m}^{-2} \text{ h}^{-1}$,
- initial volume: 25 L m⁻²,
- continuously pump the initial volume in a closed system, until a volume of 100 L m⁻² has been passed through the depth filter sheet (since $V = 500 \text{ L m}^{-2} \text{ h}^{-1}$, the duration of filtration is exactly 12 minutes),
- in case of dripping, collect the drips and add them back into the overall volume after filtration,
- once the filtration time has elapsed, stop the elution; do not drain the filter under pressure.

9.3.1 Heavy metals

The determination of heavy metals (mg metal per kg depth filter sheet) is carried out in the extract using atomic absorption spectrometry (flame/graphite furnace):

- proceed with extraction as described in point 9.3,
- the extractible heavy metal content⁷ should be less than 50 ppm.

9.3.2 Iron

⁶ According to paragraph 35 of the LMBG (German law on foodstuffs and common consumption products), method 80.56-2.

⁷ According to recommendation XXXVI/1 of the German Federal Institute for Risk Assessment (BfR).

- proceed with extraction of the iron as described in point 9.3,
- determine the corresponding concentration of cations in the filtrate,
- the iron content is determined according to the method described in Chapter II of the *International Oenological Codex*,
- the iron content should be less than 300 mg/kg.

9.3.3 Lead

- proceed with extraction of the lead as described in point 9.3,
- determine the corresponding concentration of cations in the filtrate,
- the lead content is determined according to the method described in Chapter II of the *International Oenological Codex*,
- the lead content should be less than 5 mg/kg.

9.3.4 Mercury

- proceed with extraction of the mercury as described in point 9.3,
- determine the corresponding concentration of cations in the filtrate,
- the mercury content is determined according to the method described in Chapter II of the *International Oenological Codex*,
- the mercury content should be less than 1 mg/kg.

9.3.5 Arsenic

- proceed with extraction of the arsenic as described in point 9.3,
- determine the corresponding concentration of cations in the filtrate,
- the arsenic is determined according to the method described in Chapter II of the *International Oenological Codex*,
- the arsenic content should be less than 3 mg/kg.

9.3.6 Cadmium

- proceed with extraction of the cadmium as described in point 9.3,
- determine the corresponding concentration of cations in the filtrate,
- the cadmium is determined according to the method described in Chapter II of the *International Oenological Codex*,
- the cadmium content should be less than 1 mg/kg.

10. SPECIAL RESTRICTIONS

Depth filter sheets, lenticular filter modules and all other components and products must meet the regulatory requirements for equipment in contact with food.

11. STORAGE CONDITIONS

Depth filter sheets consist of highly adsorbent materials. This product must be handled carefully during shipping and storage. Store the depth filter sheets in their

original packaging in a dry, odour-free, and well-ventilated area. Do not expose the depth filter sheets to direct sunlight. When stored correctly, filter sheets do not degrade. According to the manufacturers, it is recommended to use filter sheets within 5 years after purchase.

GELATINE
Proteinum ossii
Gelatina
OENO 13/2003

1. OBJECT, ORIGIN AND FIELD OF APPLICATION

Gelatine is the result of the partial hydrolysis of collagen contained in the skins, connective tissue and bones of animals. Gelatine comes in the form of roll sheets, flexible sheets, sprinkles, grains or colourless or slightly yellowish brown powder.

Certain gelatines are intentionally hydrolysed more than usual edible gelatines so as to be presented in ready-to-use colloidal solutions or in the form of atomised powder, soluble when cold. These products do not have the characteristic of becoming gel with water.

The structure and the iso-electric point of bovine skin gelatine proteins are different from gelatine from pork bones and rind.

Taking into account available scientific data, international standards and directives, gelatine must come from animals sources in compliance with recommendations from the International Office of Epizootics (IOE).

Gelatines are used as fining and clarification agents for wine. Gelatines react with wine tannins or additions and certain cations depending on their origin, the extraction process and their final degree of hydrolysis at the time of use in wine.

For the same quality of gelatine, the hydrolysis quality and the different phases of hydrolysis will produce products with very different behaviour concerning fining.

There is no single parameter to characterise the different types of gelatine due to their diversity.

2. LABELLING

The origin of basic edible gelatine must be indicated as well as the optimal storage conditions, expiration date and the concentration of SO₂.

3. SOLUBILITY

Basic edible gelatine swells in cold water. It dissolves in hot water (80°C to 90°C) and the solution jellifies upon cooling.

4. TEST TRIALS

4.1 Taste test

The solution in warm water should not have an unpleasant odour nor taste.

4.2 pH

Evaluate the pH on a 1% solution at 40°C,

The colloidal solution pH level is between 3 to 4,

The solutions prepared from powder or grain products have a pH level between 5 to 7.

4.3 Loss through dessication

4.3.1 Solid form gelatine:

Place 2 g of gelatine in a 70 mm diameter silica capsule with a lid. Dry in an incubator at 100°C–105°C for 6 hours. Allow to cool in a covered capsule and a desiccator. Weigh. Let the quantity of dry residue be **p** g. Weight loss should not exceed 15%.

4.3.2 Liquid form gelatine:

Put about 10 g of colloidal gelatine solution in a 70 mm diameter silica capsule. Weigh exactly this quantity in a covered capsule and dry over a water bath at 100°C for 4 hours. Then proceed by drying in an incubator at 100°C–105°C for 3 hours. Allow to cool in a covered capsule and a dessicator. Weigh the amount of dry residue. Given **p** g of this quantity. In relation to 100 g of the colloidal solution, the dry residue must reach a minimum of 5%.

All the limits set above are for the dry product.

4.4 Ashes

Incinerate the dry residue from point 4.3 by slowly heating to 600°C in a muffle furnace after sprinkling gelatine with 0.2 to 0.3g of paraffin without ashes to avoid over spilling. Total ash content should not exceed 2.0%.

4.5 Preparation of test trial solution

After being weighed, dissolve ashes in 2 ml of concentrated hydrochloric acid (R) and 10 ml of water. Heat to activate the dissolving and add distilled water until a volume equal to 25 times the weight of dried gelatine is reached. 1 ml of this solution contains mineral matter of 0.04 g of dried gelatine.

4.6 Iron

Add 1 ml of concentrated hydrochloric acid (R), one drop of concentrate potassium permanganate at 1% (R), 2 ml of potassium thiocyanate at 5% (R) to 10 ml of the test trial solution (4.5).

If a red colouration appears, it must be lighter than the control sample prepared with 2 ml of iron solution (III) at 0.010 g per litre (R), 5.2 ml of water and the same amounts of concentrated hydrochloric acid (R) and potassium thiocyanate at 5% (R).

Iron content should be less than 50 mg/kg.

It is also possible to determine iron by atomic absorption spectrophotometry. (See method described in Chapter II of the International Oenological Codex).

4.7 Chromium

Put 10 ml of test trial solution (4.5), 1 ml of ammonia persulfate solution at 15% (R), 0.5 ml of silver nitrate solution at 1% into a 50 ml conical flask. Heat and add potassium permanganate solution at 3% (R) drop by drop until the solution reaches a stable pink colour. Add a couple more drops and simmer 10 minutes. If the solution changes colour while boiling, add more potassium permanganate. After 10 minutes, add 1/10 diluted hydrochloric acid (R) until the solution is completely discoloured.

After cooling, transfer to a 20 ml graduated flask and add 2 ml of newly made 0.05% diphenylcarbazide solution in alcohol (R). Bring to 20 ml.

If a purplish red colouration appears, it must be lighter than the colour obtained when treating 4 ml of potassium dichromate solution at 0.001g of chrome per litre with 2 ml of sulphuric acid at 5% (R), 5 ml of distilled water, and after mixing add 2 ml of 0.05% diphenylcarbazide solution in alcohol (R) and bringing it up to 20 ml.

Chromium content should be less than 10 mg/kg.

It is also possible to determine chrome by atomic absorption spectrophotometry. (See method described in Chapter II of the International Oenological Codex).

4.8 Copper

Put 2.5 ml of test trial solution (4.5) in a test tube and add 7.5 ml of water, 0.5 ml of hydrochloric citric solution (R), 1 ml 5M ammonia hydroxide (R), 0.5 ml of sodium diethylthiocarbamate reagent (R). If a yellow colouration appears, it must not be darker than the solution obtained when adding the same volumes of the same reagents to 3.5 ml of a copper solution at 1 mg per litre (R) brought to 10 ml.

Copper content should be below 30 mg/kg.

It is also possible to determine copper by atomic absorption spectrophotometry (See method described in Chapter II of the International Oenological Codex).

4.9 Zinc

Put 3.75 ml of distilled water, 5 ml of buffer acetate solution (R), 1 ml of sodium thiosulfate solution at 25% (m/v) (R), 5 ml of dithizone solution at 25 mg per litre in the dichloromethane (R) in 1.25 ml of test trial solution (4.5). Shake for 2 minutes. Separate the organic phase. The colouration must be lighter than the colour obtained when treating the same volumes of the same reagents, 2.5 ml of zinc solution at 1 mg per litre (R).

Zinc content should be less than 50 mg/kg.

It is also possible to determine zinc by atomic absorption spectrophotometry. (See method described in Chapter II of the International Oenological Codex).

4.10 Lead

Using the test trial solution (4.5), determine the lead according to the method in described in Chapter II of the International Oenological Codex by atomic absorption spectrophotometry.

Lead content should be less than 5 mg/kg.

4.11 Mercury

Determine the mercury according to the method described in Chapter II of the International Oenological Codex by atomic absorption spectrophotometry.

Mercury content should be less than 0.15 mg/kg.

4.12 Arsenic

Determine the arsenic according to the method in Chapter II of the International Oenological Codex by atomic absorption spectrophotometry.

Arsenic content should be less than 1 mg/kg.

4.13 Cadmium

Determine the cadmium according to the method described in Chapter II of the International Oenological Codex by atomic absorption spectrophotometry.

Cadmium content should be less than 0.5 mg/kg.

4.14 Determining total nitrogen

Determine the total nitrogen according to the method in Chapter II of the International Oenological Codex. Total nitrogen must be more than 14% of the weight of dry gelatine.

4.15 Sulphur dioxide

Gelatine in dried form

Sulphur dioxide, freed by a little excess of phosphoric acid, starts to boil under the reflux of a flow of nitrogen. Which is oxidised and set by a hydrogen peroxide solution and measured by an acid meter in the presence of bromophenol blue, according to the reference method in the Compendium of International Methods of Analysis of Wines and Musts. This is done with a sample of 2 g of solid gelatine and on 10 ml of diluted solution at 10% of gelatine. Sulphur dioxide content should not exceed 50 mg/kg.

Gelatine in colloidal solution form

Liquid forms are stabilised with SO₂ and should not contain benzylic alcohol; sulphur dioxide content should not exceed 4 g/litre.

4.16 Urea

Determine urea using the Boehringer enzymatic method.

Content should be less than 2.5 g/kg.

4.17 Bacteria monitoring

Proceed as is indicated in Chapter II of the International Oenological Codex.

Limit: total viable micro-organisms: less than 10^4 CFU/g

4.18 *Escherichia coli*

Proceed with counting according to the method in Chapter II of the International Oenological Codex.

Absence checked on a sample of 1 g.

4.19 Salmonella

Proceed with counting according to the method in Chapter II of the International Oenological Codex.

Absence of salmonella is checked on a 25 g sample.

4.20 Coliforms

Proceed with counting according to the method in Chapter II of the International Oenological Codex.

Absence of coliform bacteria is checked on a 1 g sample.

4.21 Spores of anaerobic sulphite-reducing micro-organisms *

Proceed with counting according to the method in Chapter II of the International Oenological Codex.

Absence is checked on a 1 g sample.

4.22 *Clostridium perfringens* spores *

Proceed with counting according to the method in Chapter II of the International Oenological Codex.

Absence is checked on a 1 g sample.

4.23 Staphylococci (*Staphylococcus aureus*)

Proceed with counting according to the method in Chapter II of the International Oenological Codex.

Absence is checked on a 1 g sample.

* Method to be defined later on by the experts' group "Wine microbiology".

4.24 Yeasts

Proceed with counting according to the method in Chapter II of the International Oenological Codex.

Content limit: 10^3 CFU/g of preparation.

4.25 Total lactic bacteria

Proceed with counting according to the method in Chapter II of the International Oenological Codex.

Content limit: 10^3 CFU/ g of preparation.

4.26 Acetic bacteria

Proceed with counting according to the method in Chapter II of the International Oenological Codex.

Content limit: 10^3 CFU/ g of preparation.

4.27 Mould

Proceed with counting according to the method in Chapter II of the International Oenological Codex.

Content limit: 10^3 CFU/g of preparation.

5. STORAGE

Solid gelatine must be stored in closed containers or in a humidity-proof bag under temperate conditions.

Gelatine in ready-to-use colloidal solutions may contain preservatives authorised in wines and their concentrations must be indicated on the label.

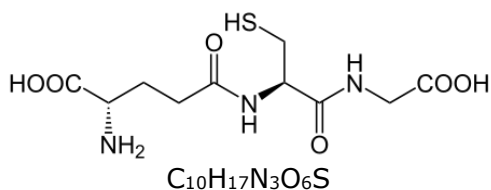
Glutathione**Chemical name: γ -L-Glutamyl-L-cysteinyl-glycine****CAS number: 70-18-8****Molecular weight: 307.33 g/mol**

OIV-OENO 571-2017

1. OBJECT, ORIGIN AND SCOPE OF APPLICATION

Reduced glutathione (GSH) is a biologically active tripeptide consisting of L-glutamate, L-cysteine and glycine. Its antioxidant properties can fight against oxidation phenomena in musts and wines and protect aromatic compounds.

GSH is principally produced by microbial fermentation. The more onerous methods of production – chemically or by enzymatic reaction – are not used on an industrial scale.

Production by microbial fermentation frequently uses *Saccharomyces cerevisiae* and *Candida utilis* or other non-*Saccharomyces* microorganisms, and more generally their mutant forms. The GSH content in cultures of mutant yeast strains is usually high (3.5%-9% of dry cell weight).

When mutants used for GSH production come from genetically modified yeasts, they must be authorised for use beforehand by the relevant authorities.

2. LABELLING

The label must indicate:

- the name or sales denomination,
- the indication 'product for oenological use, limited use',
- the GSH content,
- any additives,
- instructions for use,
- the batch number as well as the expiry date, and the storage conditions in terms of temperature, humidity and ventilation conditions,
- the name of the genus and the species of microbial sources (only if produced by microbial fermentation),

- the indication that the GSH was produced by mutants obtained by genetic modification and the modified characteristic if such is the case (only if produced by microbial fermentation),
- the name or company name and address of the manufacturer, packager or supplier,
- the net weight

3. CHARACTERISTICS

GSH is usually available in white crystalline powder form soluble in water, which results in a clear and colourless aqueous solution with a light flavour of reduction. Precautions must be taken (points 4.3. and 6) to ensure the stability of GSH in order to avoid oxidation and oxidised glutathione (GSSG) production.

3.1. Identification

3.1.1. Rotatory power

Specific rotatory power: $[\alpha]_D^{25}$: - 18.9° (c= 4.653% at T =25 °C)

3.1.2 Melting point

190-195 °C

4. LIMITS AND TEST METHODS

4.1 GSH content

Reduced glutathione (GSH) concentrations are measured by the capillary electrophoresis method described in the Annex.

The reduced glutathione content must be $\geq 98\%$.

4.2 - Humidity

Measured by the loss in the weight of 5 g of product, dried at 105 °C until the weight is constant (for approximately 3 hours). The maximum humidity of the solid form must be less than or equal to 0.5%.

4.3 - Test solution

Dissolve 1 g of GSH in 100 mL of type-I ultra-pure water (UPW). The GSH solution must be prepared each day and stored at low temperature (2-4 °C) in a brown glass bottle.

4.4 - Lead

Proceed with determination according to the method indicated in

Chapter II of the *International Oenological Codex*. The lead content must be less than 2 mg/kg of dry matter.

4.5 - Mercury

Proceed with determination according to the method indicated in Chapter II of the *International Oenological Codex*. The mercury content must be less than 1 mg/kg of dry matter.

4.6 - Arsenic

Proceed with determination according to the method indicated in Chapter II of the *International Oenological Codex*. The arsenic content must be less than 3 mg/kg of dry matter.

4.7 - Cadmium

Proceed with determination according to the method indicated in Chapter II of the *International Oenological Codex*. The cadmium content must be less than 1 mg/kg of dry matter.

4.8 - Living yeasts

Enumerate according to the method indicated in Chapter II of the *International Oenological Codex*. The live yeast count must be less than or equal to 10^2 CFU/g.

4.9 - Moulds

Enumerate according to the method indicated in Chapter II of the *International Oenological Codex*. The mould count must be less than 10^2 CFU/g.

4.10 - Lactic acid bacteria

Enumerate according to the method indicated in Chapter II of the *International Oenological Codex*. The lactic bacteria count must be less than 10^3 CFU/g.

4.11 - Acetic acid bacteria

Enumerate according to the method indicated in Chapter II of the *International Oenological Codex*. The acetic acid bacteria count must be less than 10^3 CFU/g.

4.12 - Salmonella

Enumerate according to the method indicated in Chapter II of the *International Oenological Codex*. Absence must be checked on a sample of 25 g.

4.13 - Escherichia coli

Enumerate according to the method indicated in Chapter II of the *International Oenological Codex*. Absence must be checked on a sample of 1 g.

4.14 - Staphylococci

Enumerate according to the method indicated in Chapter II of the *International Oenological Codex*. Absence must be checked on a sample of 1 g.

4.15 - Coliforms

Enumerate according to the method indicated in Chapter II of *the International Oenological Codex*. The coliform count must be less than 10 CFU/g.

5. ADDITIVES

They must comply with the currently applicable regulations.

6. STORAGE

Store in sealed packaging in a cool (2-8 °C), dry place. In all cases, refer to the manufacturer's instructions.

Annex**Determination of glutathione (GSH) in commercial preparations by capillary electrophoresis**

This determination is carried out according to the method for the determination of glutathione in musts and wines (Resolution OIV-OENO 345-2009).

The glutathione samples to be determined are prepared by dilution of the test solution (point 4.3 of the glutathione monograph) so as to obtain a final concentration of around 20 mg/L (e.g. 200 µL in 100 mL of ultra-pure water if the level of glutathione in the commercial preparation is close to 100%). If necessary, this preparation should be clarified by centrifugation before being analysed.

1. METHOD CHARACTERISTICS

Certain internal elements of validation were determined in the wine matrix (Resolution OIV-OENO 345-2009) to produce calibration curves and repeatability tests. Each concentration is calculated based on the average of three determinations obtained by using the regression line of the calibration curve. The results are expressed in mg/L. The linear regression and correlation coefficient are calculated according to the least squares method. The glutathione stock solution is produced from an HCl/EDTA solution, allowing it to be stored at +6 °C for several days with no loss. Successive dilutions of this solution allow the threshold limit of detection of the method to be estimated, for a signal-to-noise ratio of three or more.

The calibration curve is established between 0 and 40 mg/L, the linear regression equates to $Y = 0.583X - 0.948$ and the correlation coefficient is 0.9966.

These analytical conditions make it possible to eliminate interference caused by MBB hydrolysis products.

The method's repeatability is calculated on the basis of 10 analyses of the same sample of wine. For a 10 mg/L concentration, the coefficient of variation is 6.0% for glutathione.

The limit of detection of glutathione is 20 µg/L (in the wine) and the limit of quantification is 60 µg/L.

2. BIBLIOGRAPHY

See Resolution OIV-OENO 345-2009.

**GRAPE SUGAR
(RECTIFIED CONCENTRATED GRAPE MUSTS)**

OENO 4/87;
OENO 2/88;
OENO 47/2000;
OIV-OENO 419A-2011;
OENO 419B-2012;
OIV-OENO 419C-2015;
OIV-OENO 419D-2015

1. OBJECTIVE, ORIGIN AND SCOPE OF APPLICATION

Grape sugar is obtained exclusively from grape musts. The addition of grape sugar to wine is subject to regulation.

The label, or, when this is absent, the documentation accompanying the containers of grape sugar, must cite the sugar percentage.

2. PROPERTIES

Syrupy, milk-white or slightly yellowish liquid with a sugary flavor.

Refraction index at 20 °C	1.42410-1.46663
Total sugar in terms of invert sugar	63% (m/m) minimum
Absorbance at 425 nm under 1 cm at 25° Brix	maximum 0.100
pH at 25° Brix	maximum 5 *
Titration acidity in mEq/kg of sugar	maximum 15 *
Sucrose	negative
	by recommended method
Sulfur dioxide in mg/kg of sugar	maximum 25
Folin-Ciocalteu index at 25° Brix	maximum 6
Total cations in mEq/kg of sugar	maximum 8
Conductivity at 25° Brix in	
Micro-Siemens/cm (μScm^{-1})	maximum 120
5-(hydroxymethyl)furfural in mg/kg sugar	maximum 25
Residual ethanol in g/kg sugar	maximum 8
Heavy metals in mg/kg grape sugar	
expressed in terms of lead	less than 10
No antiseptics and anti-fermenting agents	

1° Brix = 1 g of sugar in 100 g of solution

* after vacuum removal of the carbon dioxide

3. TESTS

3.1. Preparing the Sample

Drawing samples for the various different analyses is difficult; therefore, the following two dilutions are recommended:

3.1.1 Principal Solution I - for the following tests: titration acidity, total sulfur dioxide and total cations
Weigh exactly 200 g of grape sugar. Fill to 500 ml with water.

3.1.2 Principal Solution II - necessary for the following tests: Folin-Ciocalteu index, pH, conductivity, sucrose test and absorbance at 425 nm.
Dilute the grape sugar with water until it has a concentration of $25^{\circ} \pm 0.5^{\circ}$ Brix (25 g of sugar in 100 g of solution).

3.2. Refraction Index at 20 °C (total sugars)

3.2.1. Equipment:

The refractometer used gives the following, based on type of graduation:

- 0.1% by mass of sucrose (or dry matter or Brix degrees)
- the 5th decimal of the index of refraction

The refractometer used should be equipped with a thermometer (+ 10 °C at + 30 °C).

3.2.2. Procedure Method:

Place two drops of grape sugar on the surface of the fixed prism. Lower the moving prism and point the instrument toward a light source that illuminates the graduated scale. Observe the line of separation on this scale between a lower clear zone and an upper dark. Read the graduation line at which this line of separation occurs and record the temperature in °C.

3.2.3. Calculation:

If the device is graduated in percentage (m/m) of sucrose (or dry matter or Brix degrees), the measurement converted to 20 °C using Table 2 is recorded in Table 1 which provides (Column 3) total sugar content in percent (m/m) expressed in terms of sugar.

If the device is graduated by refraction index, the index measured at t °C is used to obtain the corresponding value in percent of sucrose (m/m) at t °C in Table 1 (Column 1). This value as expressed at 20 °C using the temperature correction table N° 2, transferred to Table 1, which, in Column 3, gives the total sugar number in percent (m/m) of invert sugar.

To obtain the refraction index at 20 °C, refer to the total sugar content expressed in terms of invert sugar in Table 1.

3.2.4. Recording the Findings:

Total sugar content is expressed parts per 100 by mass of sucrose and is recorded with a decimal.

The refraction index at 20 °C is expressed to 5 decimal places.

3.3. Absorbance of a 25° Brix Solution at 425 nm (Chromatic characteristics)¹

Proceed to the analysis according to the method described in the Compendium of international methods of wine and must analysis (Method OIV-MA-F1-08).

3.4. Measuring pH²

Proceed to the analysis according to the method described in the Compendium of international methods of wine and must analysis (Method OIV-MA-F1-06).

3.5. Titration Acidity³

Place 10 ml of Principal Solution I in a cylindrical vessel (3.1.1). Add Proceed to the analysis according to the method described in the Compendium of international methods of wine and must analysis (Method OIV-MA-F1-05).

3.6. Sucrose Test by HPLC⁴

Proceed to the analysis according to the method described in the Compendium of international methods of wine and must analysis (Method OIV-MA-F1-04).

3.7. Sulfur Dioxide⁵

Proceed to the analysis according to the method described in the Compendium of international methods of wine and must analysis (Method OIV-MA-F1-07).

3.8. Folin-Ciocalteu Index of the 25° Brix Solution

Place the following, in order, in a 100 ml volumetric flask:

- 5 ml of Principal Solution II
- 50 ml water
- 5 ml Folin-Ciocalteu reagent (R)

¹ Modified by resolution OIV-OENO 419A-2011

² Modified by resolution OIV-OENO 419A-2011

³ Modified by resolution OIV-OENO 419A-2011

⁴ Modified by resolution OIV-OENO 419A-2011

⁵ Modified by resolution OIV-OENO 419A-2011

- 20 ml of sodium carbonate solution (R)

Fill to the 100 ml level with water. Stir to homogenize. Wait 30 minutes for the reaction to stabilize.

Determine absorbance at 750 nm in 1 cm as compared with a control prepared with water instead of Principal Solution II.

Expressing the results:

Express the results in the form of an index obtained by multiplying the absorbance by 16 in order to obtain a scale comparable to that used for wines.

3.9. Total Cations

Proceed to the analysis according to the method described in the Compendium of international methods of wine and must analysis (Method OIV-MA-F1-09).

3.10. Conductivity of the Solution at 25° Brix⁶

Proceed to the analysis according to the method described in the Compendium of international methods of wine and must analysis (Method OIV-MA-F1-01).

3.11. 5-(Hydroxymethyl)furfural(HMF)⁷

Proceed to the analysis according to the method described in the Compendium of international methods of wine and must analysis (Method OIV-MA-F1-02)

⁶ Modified by resolution OIV-OENO 419A-2011

⁷ Modified by resolution OIV-OENO 419A-2011

3.12. Heavy Metals

Proceed to the analysis according to the method described in the Compendium of international methods of wine and must analysis (Method OIV-MA-F1-10; Method OIV-MA-F1-11).

(Heavy metal content, expressed in terms of lead, should be less than 10 mg/kg).

3.13. Lead

Using the method set forth in the Compendium, quantitatively analyze lead in the Principal Solution I (3.1.1). (Lead content should be less than 1 mg/kg.)

3.14. Mercury

Using the method set forth in the annex, quantitatively analyze mercury in the Principal Solution I (3.1.1). (Mercury content should be less than 0.3 mg/kg.)

3.15. Arsenic

Using the method described in the annex, quantitatively analyze arsenic in the Principal Solution I (3.1.1). (Arsenic concentration should be less than 0.5 mg/kg.)

3.16. Ethanol⁸

Proceed to the analysis according to the method described in the Compendium of international methods of wine and must analysis (Method OIV-MA-F1-03).

3.17. Meso-Inositol

Gas phase chromatography of a silyl-containing derivative.

***N.B. :** The information given above is provided for informational purposes. There are other techniques for deriving sugars and polyhydroxy alcohols, and chromatographic methods for determining meso-inositol concentrations*

3.17.1. Preparing the sample:

Dilute 5 g of grape sugar in 50 ml of water. Dry 50 µl of the dilution and 50 µl of a methyl D-glucopyranoside solution in a concentration of 1 g/liter, (internal standard) under a vacuum in a small 2 ml flask.

Dissolve the residue with 100 µl of pyridine. Add 100 µl of trimethylchlorosilane. Seal the small flask with a teflon stopper and

⁸ Modified by resolution OIV-OENO 419A-2011

heat at 80 °C for 1 hour. Inject 1 µl with division of the injected volume to 1/60.

3.17.2. Separation

Column: apolar capillary type of fused silica 25 m long and inner diameter of 0.2 mm.

Supporting Gas: helium, 1 ml/minute

Injector and detector: 280 °C

Column temperature: 60-250 °C, at 4 °C per minute, then isothermal at 250 °C.

3.17.3. Expressing the results: g per kg of sugar

4. STORAGE

Grape sugar must be stored in impermeable containers and at ambient temperature from the time it is made.

ANNEX 1 (sugars)

TABLE 1

Sugar Content in Musts Using Refractometry

Sucrose % (m/m)	Index of refraction at 20°C	Density at 20°C	Sugars in g/l	Sugars in g/kg
50.0	1.42008	1.2342	627.6	508.5
50.1	1.42029	1.2348	629.3	509.6
50.2	1.42050	1.2355	630.9	510.6
50.3	1.42071	1.2362	632.4	511.6
50.4	1.42092	1.2367	634.1	512.7
50.5	1.42113	1.2374	635.7	513.7
50.6	1.42135	1.2381	637.3	514.7
50.7	1.42156	1.2386	638.7	515.7
50.8	1.42177	1.2391	640.4	516.8
50.9	1.42198	1.2396	641.9	517.8
51.0	1.42219	1.2401	643.4	518.8
51.1	1.42240	1.2406	645.0	519.9
51.2	1.42261	1.2411	646.5	520.9
51.3	1.42282	1.2416	648.1	522.0
51.4	1.42304	1.2421	649.6	523.0
51.5	1.42325	1.2427	651.2	524.0
51.6	1.42347	1.2434	652.9	525.1
51.7	1.42368	1.2441	654.5	526.1
51.8	1.42389	1.2447	656.1	527.1
51.9	1.42410	1.2454	657.8	528.2
52.0	1.42432	1.2461	659.4	529.2
52.1	1.42453	1.2466	661.0	530.2
52.2	1.42475	1.2470	662.5	531.3
52.3	1.42496	1.2475	664.1	532.3
52.4	1.42517	1.2480	665.6	533.3
52.5	1.42538	1.2486	667.2	534.4
52.6	1.42560	1.2493	668.9	535.4
52.7	1.42581	1.2500	670.5	536.4
52.8	1.42603	1.2506	672.2	537.5
52.9	1.42624	1.2513	673.8	538.5
53.0	1.42645	1.2520	675.5	539.5
53.1	1.42667	1.2525	677.1	540.6
53.2	1.42689	1.2530	678.5	541.5
53.3	1.42711	1.2535	680.2	542.6
53.4	1.42733	1.2540	681.8	543.7
53.5	1.42754	1.2546	683.4	544.7
53.6	1.42776	1.2553	685.1	545.8
53.7	1.42797	1.2560	686.7	546.7
53.8	1.42819	1.2566	688.4	547.8
53.9	1.42840	1.2573	690.1	548.9
54.0	1.42861	1.2580	691.7	549.8
54.1	1.42884	1.2585	693.3	550.9
54.2	1.42906	1.2590	694.9	551.9
54.3	1.42927	1.2595	696.5	553.0
54.4	1.42949	1.2600	698.1	554.0
54.5	1.42971	1.2606	699.7	555.1
54.6	1.42993	1.2613	701.4	556.1
54.7	1.43014	1.2620	703.1	557.1
54.8	1.43036	1.2625	704.7	558.2
54.9	1.43058	1.2630	706.2	559.1

INTERNATIONAL OENOLOGICAL CODEX

Grape Sugar

COEI-1-SUCRAI: 2015

TABLE 1 (Cont'd)

Sucrose % (m/m)	Index of refraction at 20°C	Density at 20°C	Sugars in g/l	Sugars in g/kg
55.0	1.43079	1.2635	707.8	560.2
55.1	1.43102	1.2639	709.4	561.3
55.2	1.43124	1.2645	711.0	562.3
55.3	1.43146	1.2652	712.7	563.3
55.4	1.43168	1.2659	714.4	564.3
55.5	1.43189	1.2665	716.1	565.4
55.6	1.43211	1.2672	717.8	566.4
55.7	1.43233	1.2679	719.5	567.5
55.8	1.43255	1.2685	721.1	568.5
55.9	1.43277	1.2692	722.8	569.5
56.0	1.43298	1.2699	724.5	570.5
56.1	1.43321	1.2703	726.1	571.6
56.2	1.43343	1.2708	727.7	572.6
56.3	1.43365	1.2713	729.3	573.7
56.4	1.43387	1.2718	730.9	574.7
56.5	1.43409	1.2724	732.6	575.8
56.6	1.43431	1.2731	734.3	576.8
56.7	1.43454	1.2738	736.0	577.8
56.8	1.43476	1.2744	737.6	578.8
56.9	1.43498	1.2751	739.4	579.9
57.0	1.43519	1.2758	741.1	580.9
57.1	1.43542	1.2763	742.8	582.0
57.2	1.43564	1.2768	744.4	583.0
57.3	1.43586	1.2773	745.9	584.0
57.4	1.43609	1.2778	747.6	585.1
57.5	1.43631	1.2784	749.3	586.1
57.6	1.43653	1.2791	751.0	587.1
57.7	1.43675	1.2798	752.7	588.1
57.8	1.43698	1.2804	754.4	589.2
57.9	1.43720	1.2810	756.1	590.2
58.0	1.43741	1.2818	757.8	591.2
58.1	1.43764	1.2822	759.5	592.3
58.2	1.43784	1.2827	761.1	593.4
58.3	1.43809	1.2832	762.6	594.3
58.4	1.43832	1.2837	764.3	595.4
58.5	1.43854	1.2843	766.0	596.4
58.6	1.43877	1.2850	767.8	597.5
58.7	1.43899	1.2857	769.5	598.5
58.8	1.43922	1.2863	771.1	599.5
58.9	1.43944	1.2869	772.9	600.6
59.0	1.43966	1.2876	774.6	601.6
59.1	1.43988	1.2882	776.3	602.6
59.2	1.44011	1.2889	778.1	603.7
59.3	1.44034	1.2896	779.8	604.7
59.4	1.44057	1.2902	781.6	605.8
59.5	1.44079	1.2909	783.3	606.8
59.6	1.44102	1.2916	785.2	607.9
59.7	1.44124	1.2921	786.8	608.9
59.8	1.44147	1.2926	788.4	609.9
59.9	1.44169	1.2931	790.0	610.9

INTERNATIONAL OENOLOGICAL CODEX

Grape Sugar

COEI-1-SUCRAI: 2015

TABLE 1 (Cont'd)

Sucrose % (m/m)	Index of refraction at 20°C	Density at 20°C	Sugars in g/l	Sugars in g/kg
60.0	1.44192	1.2936	791.7	612.0
60.1	1.44215	1.2942	793.3	613.0
60.2	1.44238	1.2949	795.2	614.1
60.3	1.44260	1.2956	796.9	615.1
60.4	1.44283	1.2962	798.6	616.1
60.5	1.44305	1.2969	800.5	617.2
60.6	1.44328	1.2976	802.2	618.2
60.7	1.44351	1.2981	803.9	619.3
60.8	1.44374	1.2986	805.5	620.3
60.9	1.44397	1.2991	807.1	621.3
61.0	1.44419	1.2996	808.7	622.3
61.1	1.44442	1.3002	810.5	623.4
61.2	1.44465	1.3009	812.3	624.4
61.3	1.44488	1.3016	814.2	625.5
61.4	1.44511	1.3022	815.8	626.5
61.5	1.44534	1.3029	817.7	627.6
61.6	1.44557	1.3036	819.4	628.6
61.7	1.44580	1.3042	821.3	629.7
61.8	1.44603	1.3049	823.0	630.7
61.9	1.44626	1.3056	824.8	631.7
62.0	1.44648	1.3062	826.6	632.8
62.1	1.44672	1.3068	828.3	633.8
62.2	1.44695	1.3075	830.0	634.8
62.3	1.44718	1.3080	831.8	635.9
62.4	1.44741	1.3085	833.4	636.9
62.5	1.44764	1.3090	835.1	638.0
62.6	1.44787	1.3095	836.8	639.0
62.7	1.44810	1.3101	838.5	640.0
62.8	1.44833	1.3108	840.2	641.0
62.9	1.44856	1.3115	842.1	642.1
63.0	1.44879	1.3121	843.8	643.1
63.1	1.44902	1.3128	845.7	644.2
63.2	1.44926	1.3135	847.5	645.2
63.3	1.44949	1.3141	849.3	646.3
63.4	1.44972	1.3148	851.1	647.3
63.5	1.44955	1.3155	853.0	648.4
63.6	1.45019	1.3161	854.7	649.4
63.7	1.45042	1.3168	856.5	650.4
63.8	1.45065	1.3175	858.4	651.5
63.9	1.45088	1.3180	860.0	652.5
64.0	1.45112	1.3185	861.6	653.5
64.1	1.45135	1.3190	863.4	654.6
64.2	1.45158	1.3195	865.1	655.6
64.3	1.45181	1.3201	866.9	656.7
64.4	1.45205	1.3208	868.7	657.7
64.5	1.45228	1.3215	870.6	658.8
64.6	1.45252	1.3221	872.3	659.8
64.7	1.45275	1.3228	874.1	660.8
64.8	1.45299	1.3235	876.0	661.9
64.9	1.45322	1.3241	877.8	662.9

TABLE 1 (Cont'd)

Sucrose % (m/m)	Index of refraction at 20°C	Density at 20°C	Sugars in g/l	Sugars in g/kg
65.0	1.45347	1.3248	879.7	664.0
65.1	1.45369	1.3255	881.5	665.0
65.2	1.45393	1.3261	883.2	666.0
65.3	1.45416	1.3268	885.0	667.0
65.4	1.45440	1.3275	886.9	668.1
65.5	1.45463	1.3281	888.8	669.2
65.6	1.45487	1.3288	890.6	670.2
65.7	1.45510	1.3295	892.4	671.2
65.8	1.45534	1.3301	894.2	672.3
65.9	1.45557	1.3308	896.0	673.3
66.0	1.45583	1.3315	898.0	674.4
66.1	1.45605	1.3320	899.6	675.4
66.2	1.45629	1.3325	901.3	676.4
66.3	1.45652	1.3330	903.1	677.5
66.4	1.45676	1.3335	904.8	678.5
66.5	1.45700	1.3341	906.7	679.6
66.6	1.45724	1.3348	908.5	680.6
66.7	1.45747	1.3355	910.4	681.7
66.8	1.45771	1.3361	912.2	682.7
66.9	1.45795	1.3367	913.9	683.7
67.0	1.45820	1.3374	915.9	684.8
67.1	1.45843	1.3380	917.6	685.8
67.2	1.45867	1.3387	919.6	686.9
67.3	1.45890	1.3395	921.4	687.9
67.4	1.45914	1.3400	923.1	688.9
67.5	1.45938	1.3407	925.1	690.0
67.6	1.45962	1.3415	927.0	691.0
67.7	1.45986	1.3420	928.8	692.1
67.8	1.46010	1.3427	930.6	693.1
67.9	1.46034	1.3434	932.6	694.2
68.0	1.46060	1.3440	934.4	695.2
68.1	1.46082	1.3447	936.2	696.2
68.2	1.46106	1.3454	938.0	697.2
68.3	1.46130	1.3460	939.9	698.3
68.4	1.46154	1.3466	941.8	699.4
68.5	1.46178	1.3473	943.7	700.4
68.6	1.46202	1.3479	945.4	701.4
68.7	1.46226	1.3486	947.4	702.5
68.8	1.46251	1.3493	949.2	703.5
68.9	1.46275	1.3499	951.1	704.6
69.0	1.46301	1.3506	953.0	705.6
69.1	1.46323	1.3513	954.8	706.6
69.2	1.46347	1.3519	956.7	707.7
69.3	1.46371	1.3526	958.6	708.7
69.4	1.46396	1.3533	960.6	709.8
69.5	1.46420	1.3539	962.4	710.8
69.6	1.46444	1.3546	964.3	711.9
69.7	1.46468	1.3553	966.2	712.9
69.8	1.46493	1.3560	968.2	714.0
69.9	1.46517	1.3566	970.0	715.0

INTERNATIONAL OENOLOGICAL CODEX

Grape Sugar

COEI-1-SUCRAI: 2015

TABLE 1 (end)

Sucrose % (m/m)	Index of refraction at 20°C	Density at 20°C	Sugars in g/l	Sugars in g/kg
70.0	1.46544	1.3573	971.8	716.0
70.1	1.46565	1.3579	973.8	717.1
70.2	1.46590	1.3586	975.6	718.1
70.3	1.46614	1.3593	977.6	719.2
70.4	1.46639	1.3599	979.4	720.2
70.5	1.46663	1.3606	981.3	721.2
70.6	1.46688	1.3613	983.3	722.3
70.7	1.46712	1.3619	985.2	723.4
70.8	1.46737	1.3626	987.1	724.4
70.9	1.46761	1.3633	988.9	725.4
71.0	1.46789	1.3639	990.9	726.5
71.1	1.46810	1.3646	992.8	727.5
71.2	1.46835	1.3653	994.8	728.6
71.3	1.46859	1.3659	996.6	729.6
71.4	1.46884	1.3665	998.5	730.7
71.5	1.46908	1.3672	1000.4	731.7
71.6	1.46933	1.3678	1002.2	732.7
71.7	1.46957	1.3685	1004.2	733.8
71.8	1.46982	1.3692	1006.1	734.8
71.9	1.47007	1.3698	1008.0	735.9
72.0	1.47036	1.3705	1009.9	736.9
72.1	1.47056	1.3712	1012.0	738.0
72.2	1.47081	1.3718	1013.8	739.0
72.3	1.47106	1.3725	1015.7	740.0
72.4	1.47131	1.3732	1017.7	741.1
72.5	1.47155	1.3738	1019.5	742.1
72.6	1.47180	1.3745	1021.5	743.2
72.7	1.47205	1.3752	1023.4	744.2
72.8	1.47230	1.3758	1025.4	745.3
72.9	1.47254	1.3765	1027.3	746.3
73.0	1.47284	1.3772	1029.3	747.4
73.1	1.47304	1.3778	1031.2	748.4
73.2	1.47329	1.3785	1033.2	749.5
73.3	1.47354	1.3792	1035.1	750.5
73.4	1.47379	1.3798	1037.1	751.6
73.5	1.47404	1.3805	1039.0	752.6
73.6	1.47429	1.3812	1040.9	753.6
73.7	1.47454	1.3818	1042.8	754.7
73.8	1.47479	1.3825	1044.8	755.7
73.9	1.47504	1.3832	1046.8	756.8
74.0	1.47534	1.3838	1048.6	757.8
74.1	1.47554	1.3845	1050.7	758.9
74.2	1.47579	1.3852	1052.6	759.9
74.3	1.47604	1.3858	1054.6	761.0
74.4	1.47629	1.3865	1056.5	762.0
74.5	1.47654	1.3871	1058.5	763.1
74.6	1.47679	1.3878	1060.4	764.1
74.7	1.47704	1.3885	1062.3	765.1
74.8	1.47730	1.3892	1064.4	766.2
74.9	1.47755	1.3898	1066.3	767.2
75.0	1.47785	1.3905	1068.3	768.3

TABLE 2
Correction of the Conventional Sugar Mass Titer as a Function of Temperature
Mass Titer Measured in %

Tempé- rature °C	10	15	20	25	30	35	40	45	50	55	60	65	70	75	
5	-0,82	-0,87	-0,92	-0,95	-0,99										
6	-0,80	-0,82	-0,87	-0,90	-0,94										
7	-0,74	-0,78	-0,82	-0,84	-0,88										
8	-0,69	-0,73	-0,76	-0,79	-0,82										
9	-0,64	-0,67	-0,71	-0,73	-0,75										
10	-0,59	-0,62	-0,65	-0,67	-0,69	-0,71	-0,72	-0,73	-0,74	-0,75	-0,75	-0,75	-0,75	-0,75	
11	-0,54	-0,57	-0,59	-0,61	-0,63	-0,64	-0,65	-0,66	-0,67	-0,68	-0,68	-0,68	-0,68	-0,67	
12	-0,49	-0,51	-0,53	-0,55	-0,56	-0,57	-0,58	-0,59	-0,60	-0,60	-0,61	-0,61	-0,60	-0,60	
13	-0,43	-0,45	-0,47	-0,48	-0,50	-0,51	-0,52	-0,52	-0,53	-0,53	-0,53	-0,53	-0,53	-0,53	
14	-0,38	-0,39	-0,40	-0,42	-0,43	-0,44	-0,44	-0,45	-0,45	-0,46	-0,46	-0,46	-0,46	-0,45	
15	-0,32	-0,33	-0,34	-0,35	-0,36	-0,37	-0,37	-0,38	-0,38	-0,38	-0,38	-0,38	-0,38	-0,38	
16	-0,26	-0,27	-0,28	-0,28	-0,29	-0,30	-0,30	-0,30	-0,31	-0,31	-0,31	-0,31	-0,31	-0,30	
17	-0,20	-0,20	-0,21	-0,21	-0,22	-0,22	-0,23	-0,23	-0,23	-0,23	-0,23	-0,23	-0,23	-0,23	
18	-0,13	-0,14	-0,14	-0,14	-0,15	-0,15	-0,15	-0,15	-0,15	-0,15	-0,15	-0,15	-0,15	-0,15	
19	-0,07	-0,07	-0,07	-0,07	-0,07	-0,08	-0,08	-0,08	-0,08	-0,08	-0,08	-0,08	-0,08	-0,08	
20	0	R É F É R E N C E													0
21	+0,07	+0,07	+0,07	+0,07	+0,08	+0,08	+0,08	+0,08	+0,08	+0,08	+0,08	+0,08	+0,08	+0,08	
22	+0,14	+0,14	+0,15	+0,15	+0,15	+0,15	+0,16	+0,16	+0,16	+0,16	+0,16	+0,16	+0,15	+0,15	
23	+0,21	+0,22	+0,22	+0,23	+0,23	+0,23	+0,23	+0,24	+0,24	+0,24	+0,24	+0,23	+0,23	+0,23	
24	+0,29	+0,29	+0,30	+0,30	+0,31	+0,31	+0,31	+0,32	+0,32	+0,32	+0,32	+0,31	+0,31	+0,31	
25	+0,36	+0,37	+0,38	+0,38	+0,39	+0,39	+0,40	+0,40	+0,40	+0,40	+0,40	+0,39	+0,39	+0,39	
26	+0,44	+0,45	+0,46	+0,46	+0,47	+0,47	+0,48	+0,48	+0,48	+0,48	+0,48	+0,47	+0,47	+0,46	
27	+0,52	+0,53	+0,54	+0,55	+0,55	+0,56	+0,56	+0,56	+0,56	+0,56	+0,56	+0,55	+0,55	+0,54	
28	+0,60	+0,61	+0,62	+0,63	+0,64	+0,64	+0,64	+0,65	+0,65	+0,64	+0,64	+0,64	+0,63	+0,62	
29	+0,68	+0,69	+0,70	+0,71	+0,72	+0,73	+0,73	+0,73	+0,73	+0,73	+0,72	+0,72	+0,71	+0,70	
30	+0,77	+0,78	+0,79	+0,80	+0,81	+0,81	+0,81	+0,82	+0,81	+0,81	+0,81	+0,80	+0,79	+0,78	
31	+0,85	+0,87	+0,88	+0,89	+0,89	+0,90	+0,90	+0,90	+0,90	+0,90	+0,89	+0,88	+0,87	+0,86	
32	+0,94	+0,95	+0,96	+0,97	+0,98	+0,99	+0,99	+0,99	+0,99	+0,98	+0,97	+0,96	+0,95	+0,94	
33	+1,03	+1,04	+1,05	+1,06	+1,07	+1,08	+1,08	+1,08	+1,07	+1,07	+1,06	+1,05	+1,03	+1,02	
34	+1,12	+1,19	+1,15	+1,15	+1,16	+1,17	+1,17	+1,17	+1,16	+1,15	+1,14	+1,13	+1,12	+1,10	
35	+1,22	+1,23	+1,24	+1,25	+1,25	+1,26	+1,26	+1,25	+1,25	+1,24	+1,23	+1,21	+1,20	+1,18	
36	+1,31	+1,32	+1,33	+1,34	+1,35	+1,35	+1,35	+1,35	+1,34	+1,33	+1,32	+1,30	+1,28	+1,26	
37	+1,41	+1,42	+1,43	+1,44	+1,44	+1,44	+1,44	+1,44	+1,43	+1,42	+1,40	+1,38	+1,36	+1,34	
38	+1,51	+1,52	+1,53	+1,53	+1,54	+1,54	+1,53	+1,53	+1,52	+1,51	+1,49	+1,47	+1,45	+1,42	
39	+1,61	+1,62	+1,62	+1,63	+1,63	+1,63	+1,63	+1,62	+1,61	+1,60	+1,58	+1,56	+1,53	+1,50	
40	+1,71	+1,72	+1,72	+1,73	+1,73	+1,73	+1,72	+1,71	+1,70	+1,69	+1,67	+1,64	+1,62	+1,59	

(N.B. : In the French original reproduced here, commas should be replaced with decimal points)

TABLE 3

**Conductivity Corrections for Temperatures Other Than
20°C in μ siemens/cm⁻¹**

	Temperatures									
	20.2	20.4	20.26	20.8	21.0	21.2	21.4	21.6	21.8	22.0(1)
	19.8	19.6	19.4	19.2	19.0	18.8	18.6	18.4	18.2	18.0(2)
Conductivity										
0	0	0	0	0	0	0	0	0	0	0
50	0	0	1	1	1	1	1	2	2	2
100	0	1	1	2	2	3	3	3	4	4
150	1	1	2	3	3	4	5	5	6	7
200	1	2	3	3	4	5	6	7	8	9
250	1	2	3	4	6	7	8	9	10	11
300	1	3	4	5	7	8	9	11	12	13
350	1	3	5	6	8	9	11	12	14	15
400	2	3	5	7	9	11	12	14	16	18
450	2	3	6	8	10	12	14	16	18	20
500	2	4	7	9	11	13	15	18	20	22
550	2	5	7	10	12	14	17	19	22	24
600	3	5	8	11	13	16	18	21	24	26

(1) Subtract the correction

(2) Add the correction

GUM ARABIC
Gumme arabicum
Acaciae gummi
SIN No. 414
OENO 27/2000

1. OBJECTIVE, ORIGIN AND SCOPE OF APPLICATION

Gum arabic is a gummy exudation which hardens in air and flows naturally or through cuts made in tree trunks and branches of the *L. Acacia senegal* L. Willdenow and other African *Acacia* species. It is composed of spherical tear drop-shaped globules, or sometimes irregular oval shapes with a diameter of 1-3 cm.

Gum arabic exists in powder form or in colloidal solution.

The product is used to improve the stability of bottled wine.

Gum arabic is composed of a polysaccharide rich in galactose and arabinose along with a small protein fraction which gives its stabilizing power with respect to the precipitation of coloring substances and iron or copper breakdown.

There are limits imposed on the quantity of gum arabic used in wine.

2. LABELING

The label should indicate the gum arabic solution concentration and sulfur dioxide content (there are limits imposed on the sulfur dioxide content in wine), as well as its safety and storage conditions.

3. PROPERTIES

Gum arabic tear drops are relatively friable and break cleanly into fragments. Whole tear drops often have a small cavity in the center.

Powdered gum arabic is odorless, tasteless, and has a white or yellow transparent color and glassy luster. It dissolves slowly in twice its weight and leaves only a slight residue of vegetable debris. It is insoluble in alcohol.

Gum arabic in solution is a yellowish-white viscous, translucent liquid which is slightly acidic. It precipitates abundantly when an equal volume of ethanol is added.

4. TESTS**4.1. Desiccation loss***4.1.1. Powdered gum arabic*

Place 5 g of gum arabic in a silica dish with a diameter of 70 mm. Place in a n oven at 100-105 °C for 5 hours. Weight loss should be no greater than 15 pp 100.

4.1.2. Gum arabic in solution

Place 10 g of gum arabic solution in a silica dish with a diameter of 70 mm. Place in a water bath at 100 °C for 4 hours, then in an oven set to 100-105° C for 3 hours. The quantity of dry residue should be at least 10 pp 100.

The limiting values indicated below are for dry product.

4.2. Ash

Incinerate the dry residue at 550-600 °C. Ash content should not be greater than 4 pp 100.

4.3. Preparing the Solution for Tests

The ash from 5 g of powdered gum arabic or from a weight of solution corresponding to 5 g of solid gum arabic are taken up by 2 ml of concentrated hydrochloric acid (R). Place in a 100 °C water bath with a stirring apparatus to ensure solubilizing. Decant in a 50 ml volumetric flask and bring the volume to 50 ml using wash water from the dish used during incineration.

4.4. Iron

Add 1 drop of 1 pp 100 potassium permanganate (R), 1 ml of concentrated hydrochloric acid (R) and 2 ml 2 ml of 5 pp 100 potassium thiocyanate to 10 ml of the solution prepared for tests under paragraph 4.3. The resulting coloration should be less intense than that of a control prepared with 6 ml of an iron (III) solution with 10 mg of iron per liter (R), 4 ml of water, 1 ml of concentrated hydrochloric acid (R) and 2 ml of 5 pp 100 potassium thiocyanate (R). (Iron content should be less than 60 mg/kg).

Iron content can also be quantified by atomic absorption spectrometry using the technique explained in the Compendium.

4.5. Cadmium

Using the techniques described in the annex, determine the cadmium content in the test solution prepared in accordance with Par. 4.3. (Content should be less than 1 mg/kg.)

4.6. Lead

Using the techniques described in the Compendium, determine the lead content in the test solution prepared in accordance with Par. 4.3. (Content should be less than 5 mg/kg.)

4.7. Mercury

Using the techniques described in the annex, determine the mercury content in the test solution prepared in accordance with Par. 4.3. (Content should be less than 1 mg/kg.)

4.8. Arsenic

Mineralize 0.5 g of dry gum arabic using the nitrosulfuric method and test for arsenic using the method described in the Annex. (Arsenic content should be less than 3 mg/kg).

4.9. Total nitrogen

Place 5 g of gum arabic in a 300 ml mineralization cucurbit with 15 ml of concentrated sulfuric acid (R) and 2 g of mineralization catalyst. Proceed with the quantitative analysis as indicated in the annex.

For gum arabic in solution, weigh an amount corresponding to 5 g dry residue. Evaporate until almost dry, then proceed as described before.

(Nitrogen content should be less than 4 g/kg).

Nitrogen content should be between:

0.25% and 0.4% (m/m) for Senegal Acacia gum and

0.10% and 0.20% (m/m) for Seyal Acacia gum.

4.10. Starch and Dextrin

Bring 20 ml of solution containing 2 g of dry gum arabic to a boil. Cool. Add 0.2 ml of 0.05M iodine. No blue or red-brown coloration should appear.

4.11. Tannin

Add 0.1 ml of iron (III) sulfate (R) to 10 ml of solution containing 1 g of dry gum arabic. A gelatinous precipitate will form, but neither the precipitate nor the liquid should become dark blue.

4.12. Rotatory power

Specific rotatory power is measured at 589 nm (sodium line) and for a solution with 1 g/ml of gum and a length of 1 dm.

$$- 26^{\circ} \leq [\alpha]_{D}^{20^{\circ}C} \leq - 34^{\circ}, \text{ for Senegal Acacia gum}$$

$40 \leq [\alpha]_D^{20^\circ} \leq 50^\circ$, for Senegal seya gum.

4.13. Salmonella

A 1 g sample must be free from salmonellosis (determination procedure described in the annex).

4.14. Escherichia coli

A 1 g sample must be free from *Escherichia coli* (determination procedure described in the annex).

4.15. Hydrolytic Products

Mannose, xylose, and galacturonic acid should not be present (as determined by chromatography).

4.16. Efficacy Test for Gum Arabic

4.16.1 Principle

Determine the quantity of gum arabic required to prevent flocculation of a colloidal iron (III) hexacyanoferrate (II) solution in an aqueous-alcoholic medium by calcium salt.

4.16.2. Products

Crystallized tartaric acid: Molar weight = 150.05

Purified potassium sulfate (K_2SO_4): Molar weight = 174.25

Dihydrus calcium chloride ($CaCl_2 \cdot 2H_2O$): Molar weight = 143.03

Crystallized iron (III) chloride ($FeCl_3 \cdot 6H_2O$): Molecular weight = 270.32

Potassium hexacyanoferrate (II) ($K_4[Fe(CN)_6]$): Molecular weight = 422.4

Metatartaric acid

1M sodium hydroxide solution

Ethanol, 95% by volume

20 volumes hydrogen peroxide solution

4.16.3. Protocol

Gum arabic solution in a concentration of 5 g/l (A)

Dissolve 5 g of gum arabic in 100 ml of distilled water, then dilute this solution to 1/10 strength using distilled water.

Iron (III) solution in a concentration of 2.5 g iron/l (B)

Weigh exactly 1.21 g of iron (III) chloride and place it in a 100 ml volumetric flask. Fill to 3/4 with distilled water and add 0.1 ml of

hydrogen peroxide solution at 20 volumes. Adjust to the flask mark with distilled water.

Calcium chloride solution in a concentration of 27 g/l (C)

Dissolve exactly 2.7 g of dihydrous calcium chloride in 100 ml of distilled water.

Hydro-alcoholic Matrix (D)

Fill a 1 liter volumetric flask half way with distilled water, then dissolve the following in order:

Tartaric acid: 2.5 g

K₂SO₄: 1 g (complete dissolution before proceeding to the following)

Metatartaric acid: 50 mg

Ethanol, 95% by volume: 120 ml

1M NaOH: 10 ml

Adjust the pH of the matrix to 3.5 by adding 1M NaOH (1-2 ml). Homogenize and top off with distilled water.

Potassium hexacyanoferrate (II) solution in a concentration of 12.5 g/l (E)

Weigh exactly 0.25 g of potassium hexacyanoferrate and place it in a 20 ml volumetric flask. Top off with distilled water.

This preparation should be made extemporaneously.

4.16.4. Test

Place the liter of matrix (D) in a flask and add exactly 2 ml of potassium hexacyanoferrate (II) solution (E). Place a stopper in the flask and shake. Next, add 1 ml of iron (III) chloride solution (B). Shake and let sit one-half hour. Solution S (blue in color).

In a series of test tubes (capacity > 50 ml), pour increasing volumes of gum solution in concentrations of 5 g/l (A): 0 - 0.25 - 0.5 - 0.75 - 1.0 - 1.25 - 1.5 - 1.75 - 2.0 - 2.5 - 3.0 ml. These volumes correspond to final gum concentrations of 0 - 25 - 50 - 75 - 100 - 125 - 150 - 175 - 200 - 250 and 300 mg/l.

Place 50 ml of solution S to each test tube. Shake and let sit 5 minutes.

Next, pour 1 ml of calcium chloride solution (C) into each tube. Place a stopper in the tube and agitate.

Store the tubes at ambient temperature ($\approx 25\text{ }^{\circ}\text{C}$) and out of the light.

After 3 days, read:

The control tube should have a deep blue deposit with a nearly colorless surfactant. This deposit will be more or less significant in the other tubes depending on the efficacy and dose of gum added.

In one tube, a solution with a homogeneous color and no blue deposit at the bottom will be seen. This corresponds to the quantity in mg/l of efficacious gum arabic to use in the wine.

5. STORAGE

Solid gum arabic has a very long shelf life if stored in a dry, temperate place in sealed packages. Solutions have a limited shelf life due to the presence of sulfur dioxide.

KAOLIN
Kaolinum
OENO 28/2000

1. OBJECTIVE, ORIGIN AND SCOPE OF APPLICATION

Kaolin is a natural hydrated aluminum silicate.
It is used as a clarification agent in wines.

2. LABELING

The label should indicate purity and safety and storage conditions.

3. PROPERTIES

Fine white or yellowish-white powder which is oily to the touch. When weakened in hot water it releases a clay-like odor. It is insoluble in water and dilute acids.

The product of the alkaline liquefaction of kaolin taken up by water exhibits the reaction properties of alkaline aluminates and alkaline silicates.

4. TESTS**4.1. Consistency**

Mix 1 g of kaolin with 1ml of water. The resulting paste should not be runny.

4.2. Water Loss at 700 °C

Burn a precisely-weighed sample of about 1 g of kaolin at 700 °C. Weight loss should not be greater than 15 pp 100.

4.3. Products Soluble in Dilute Acids

Weaken 1 g of kaolin in 50 ml of 0.2M hydrochloric acid. Bring to a boil under reflux for 15 minutes. Filter. The filtrate, when evaporated then incinerated, should not leave a residue of more than 2 pp 100.

4.4. Preparing the Solution for Tests

Macerate 5 g of kaolin with 100 ml of citric acid in a concentration of 5 g per liter with a pH of 3.5 for 24 hours, stirring from time to time. Filter.

4.5. Soluble Iron

Add 1 ml of concentrated hydrochloric acid (R) and 5 ml of 5 pp 100 potassium thiocyanate to 10 ml of the solution prepared for tests under paragraph 4.4. The resulting coloration should be less intense than that

of a control prepared with 5 ml of an iron solution in a concentration of 0.010 g of iron per liter (R), 5 ml of citric acid in a concentration of 20 g per liter (R), 1 ml of concentrated hydrochloric acid (R) and 5 ml of 5 pp 100 potassium thiocyanate (R). (Soluble iron content should be less than 100 mg/kg).

It is also possible to determine iron content using the atomic absorption photometry method described in the Compendium.

4.6. Calcium

To 5 ml of the solution prepared for tests under paragraph 4.4, add 5 ml of ammonium oxalate in a 4 pp 100 solution (R), 5 drops of bromophenol blue (R) and a sufficient quantity of concentrated ammonium hydroxide (R) to turn the indicator blue. There should be no clouding.

4.7. Soluble Magnesium and Aluminum

To 5 ml of the solution prepared for tests under paragraph 4.4, add 5 ml of 10 pp 100 sodium phosphate solution (R), 1 drop of phenolphthalein in a concentration of 1 g per 100 ml alcohol at 90% by volume (R) and a sufficient quantity of diluted ammonium hydroxide (R) to obtain a pink coloration. No precipitate should form in less than one hour.

4.8. Lead

Using the technique described in the Compendium, determine the lead content in the test solution prepared in accordance with Par. 4.4. (Lead content should be less than 5 mg/kg.)

4.9. Mercury

Using the technique described in the annex, determine the mercury content in the test solution prepared in accordance with Par. 4.4. (Content should be less than 1 mg/kg.)

4.10. Arsenic

Using the technique described in the annex, determine the mercury content in the test solution prepared in accordance with Par. 4.4. (Content should be less than 3 mg/kg.)

4.11. Evaluation of Coarse Particles

Place a suspension of 5 g of kaolin in 60 ml of a 1 pp 100 tetrasodic pyrophosphate solution (R) in a 250 ml test tube (diameter of approximately 40 mm) with an emery stopper. Shake vigorously for 1-2 minutes. Let sit for 5 minutes then use a siphon to draw off 50 ml of the suspension. The siphon should have two tubes whose length ratio is

2:5. It should consist of a glass tube with a diameter of 5 mm. The tip of the small tube, which should be suitably tapered, is then placed and maintained below the surface of the liquid so the siphon is drained once 50 ml of the suspension have been drawn.

Add 50 ml of water to the remaining liquid. Stir and let sit 5 minutes, then take another 50 ml sample with the siphon. Repeat this procedure until 400 ml of water have been taken up. Finally, decant the residue remaining in the test tube into a calibrated crucible.

Dry evaporate, then ddry at 100 °C for 15 minutes. Weigh. The residue should not be greater than 2 pp 100.

4.12. Adsorption Power

Place 1 g kaolin and 10 ml 0.01M methylene blue in a test tube with a stopper and let the deposit form. Centrifuge the solution and dilute 100 times. The solution should be no more intensely colored than a 0.08 mM methylene blue solution.

5. STORAGE

Kaolin should be stored in well-ventilated, places at moderate temperatures in airtight containers and away from volatile substances it can adsorb.

INACTIVATED YEASTS

OIV-OENO 459-2013

1. OBJECT, ORIGIN AND SCOPE OF APPLICATION

Inactivated yeasts are used as nutrients for yeasts at the beginning of and during alcoholic fermentation, and also to encourage the rehydration of active dry yeasts. They can help to reduce the level of Ochratoxin A in the steps for wine maturing and clarification operations.¹

They are produced by the biomass of *Saccharomyces spp.*, inactivated by heat and/or by modification of the pH. They may have undergone the beginnings of a natural autolysis through the action of the endogenous enzymes. Production techniques are those conventionally used for the biomass of yeasts. In the process, there is no addition of antibiotics or of compounds other than those needed to grow the yeast.

When inactivated yeasts come from genetically modified yeasts, they must be authorised for use beforehand by the relevant authorities.

2. LABELLING

The label must indicate:

- the name of the genus and the species of inactivated yeasts,
- the organic nitrogen content,
- any additives,
- instructions for use,
- the batch number as well as the expiry date, and the storage conditions in terms of well-defined temperature, humidity, and ventilation conditions,
- the indication that the inactivated yeasts are derived from yeasts obtained by genetic modification and the modified characteristic if such is the case.

3. CHARACTERISTICS

¹ Code of sound vitivinicultural practices in order to minimise levels of Ochratoxin A in vine-based products

In solid form they are usually available as granules, powder or flakes, of light to tan yellow in colour, with an odour characteristic of yeast. Inactivated yeasts are partially soluble in water, the insoluble part being greater than or equal to 60% m/m of the dry matter.

4. LIMITS AND TEST METHODS

4.1 - Nitrogen content

4.1.1 The total nitrogen content, expressed as element N, is less than 10% of the dry matter, according to the method of analysis described in Chapter II of the International Oenological Codex.

4.1.2 The ammoniacal nitrogen content, expressed as element N, must be less than 0.5% of the dry matter and is determined according to the following method of analysis.

Place 1 g of dry matter in 100 mL of 0.5 M KCl and stir for 20-30 min. Introduce the 100 mL into the steam distillation apparatus described in Chapter II of the International Oenological Codex for the determination of total nitrogen, add 50 mL of 30% sodium hydroxide (R) and distil by collecting 250 mL in a conic flask containing 5 mL of 4% boric acid (R), 10 mL of water and 2-3 drops of methyl red-methylene blue mixed indicator (R).

Titrate the distillate with 0.1 M hydrochloric acid until the indicator turns pink-purple.

1 mL of hydrochloric acid solution corresponds to 1.4 mg of nitrogen N.

Where n is the number of ml poured:

100 g of inactive dry yeasts contain $0.14n$ g of ammoniacal nitrogen, expressed as element N.

4.1.3 The organic nitrogen content is obtained through the difference between the total nitrogen content and the ammoniacal nitrogen content.

4.1.4 The free and soluble amino-acids and small peptides content must be lower than 10% of dry matter in glycine equivalent, according to the DNFB method described in the appendix, or, if expressed as element N, must be 1.9% of the dry matter.

4.2 - Humidity

This is measured by the loss in weight of 5 g of product, dried at 105°C until the weight is constant (approximately 3 hours).

The maximum humidity must be less than 7%.

4.3 - Lead

Determination according to the method indicated in Chapter II of the International Oenological Codex

The lead content must be less than 2 mg / kg of dry matter.

4.4 - Mercury

Determination according to the method indicated in Chapter II of the International Oenological Codex

The mercury content must be less than 1 mg / kg of dry matter.

4.5 - Arsenic

Determination according to the method indicated in Chapter II of the International Oenological Codex

The arsenic content must be less than 3 mg / kg of dry matter.

4.6 - Cadmium

Determination according to the method indicated in Chapter II of the International Oenological Codex

The cadmium content must be less than 1 mg / kg of dry matter.

4.7 - Viable yeasts

Enumerate according to the method indicated in Chapter II of the International Oenological Codex

The viable yeast count must be less than or equal to 10^2 CFU / g.

4.8 - Moulds

Enumerate according to the method indicated in Chapter II of the International Oenological Codex

The mould count must be less than 10^3 CFU / g of dry matter.

4.9 - Lactic bacteria

Enumerate according to the method indicated in Chapter II of the International Oenological Codex

The lactic bacteria count must be less than 10^3 CFU / g of dry matter.

4.10 - Acetic bacteria

Enumerate according to the method indicated in Chapter II of the International Oenological Codex

The acetic bacteria count must be less than 10^3 CFU / g of dry matter.

4.11 - Salmonella

Enumerate according to the method indicated in Chapter II of the International Oenological Codex

Absence must be checked on a sample of 25 g of dry matter.

4.12 - Escherichia coli

Enumerate according to the method indicated in Chapter II of the International Oenological Codex

Absence must be checked on a sample of 1 g of dry matter.

4.13 - Staphylococci

Enumerate according to the method indicated in Chapter II of the International Oenological Codex

Absence must be checked on a sample of 1 g of dry matter.

4.14 - Coliforms

Enumerate according to the method indicated in Chapter II of the International Oenological Codex

The coliform count must be less than 10^2 CFU / g of dry matter.

5. ADDITIVES

They must comply with the currently applicable regulations.

6. STORAGE

Inactivated yeasts must always be stored in sealed bags sheltered from the air. Store in a cool, dry place.

In all cases, refer to the manufacturer's instructions.

Appendix 1**Dinitrofluorobenzene method****1. Introduction**

This method is used to quickly determine the amino nitrogen in a biological solution compared with a standard range produced with a solution of glycine.

2. Scope of application

Oenological products of plant or animal origin.

3. Definition

Dinitrofluorobenzene (DNFB) reacts with free NH_2 functions contained in the amino acids to give a bright yellow compound determined by colorimetry at 420 nm. The reaction takes place at a $\text{pH} > 9.3$.

4. Reagents and Products

Reagents:

- Borax or sodium tetraborate,
- Dinitrofluorobenzene,
- 10 M Hydrochloric acid,
- Glycine.

5. Apparatus

- Haemolysis tubes,
- Micropipettes,
- Spectrophotometer for measurements in the visible range,
- Water bath at 60°C.

6. Sampling

- Prepare a solution of 5% sodium tetraborate in pure water,
- Prepare a DNFB solution: introduce 130 μL of DNFB in 10 mL of 95% vol. Ethanol,
- Prepare a 2M hydrochloric acid solution,
- Produce a standard range from a 2 g/L stock solution of glycine ($M = 75.07$ g) e.g. 0.50 mg/L, 100 mg/L, 200 mg/L, 500 mg/L,
- Prepare a solution with 2 g/L of the product to be determined.

7. Procedure

- In a haemolysis tube, insert:
- 380 μL of 5% Borax,

- 20 µL of the sample to be determined,
- 20 µL of the DNFB solution,
- Perform in identical fashion for the glycine range,
- Stir and place in the water bath at 60°C for 30 min,
- Add 3 mL of 2M HCl,
- Stir and read the specific absorbance at 420 nm for the sample,
- Produce a calibration curve with the Glycine range.

8. Results

Plot the value of absorbance at 420 nm for the sample on the calibration curve.

The results are expressed in g/L of Glycine.

INACTIVATED YEASTS WITH GUARANTEED GLUTATHIONE LEVELS

OIV-OENO 603-2018

1. OBJECT, ORIGIN AND SCOPE OF APPLICATION

These inactivated dry yeasts (IDY) with guaranteed glutathione levels are characterised by higher levels of reduced glutathione than those contained in standard inactivated yeasts. They are used to limit oxidation phenomena in musts and wines. The presence of reduced glutathione (GSH) may be accompanied by that of its precursors, cysteine and – in particular – gamma-glutamylcysteine. Like classic inactivated dry yeasts, they also provide nutrients for yeasts at the start of and during alcoholic fermentation. They may help to reduce ochratoxin-A levels in wines during maturing and clarification operations¹ (Resolution OENO 459-2013).

They are derived from *Saccharomyces* and/or *non-Saccharomyces* species' biomass, whose cultivation is managed so as to increase the natural production of reduced glutathione (GSH). They are therefore derived from pure cultures without any subsequent addition of glutathione or of cysteine and gamma-glutamyl-cysteine to the final product, what is attested by a ratio between gamma-glutamyl-cysteine and GSH that must be superior to 20%.

They are inactivated by heat and/or by pH modification. They may have been subjected to the start of natural autolysis under the action of endogenous enzymes. No antibiotics or other compounds are added in the process other than those necessary for yeast growth.

When the inactivated yeasts come from genetically engineered yeasts, these must have received the preliminary authorisation of the relevant authorities.¹

2. LABELLING

The following must appear on the label:

- the name of the genus and species of the inactivated yeasts **with guaranteed glutathione levels,**

¹ Code of good vitivinicultural practices in order to minimise the presence of OTA in vine-based products.

- the minimum content , expressed in mg/g of inactivated dry yeasts (IDY), of reduced glutathione
- the maximum content, expressed in mg/g of inactivated dry yeasts (IDY), of cysteine
- the maximum content, expressed in mg/g of inactivated dry yeasts (IDY), of gamma-glutamyl-cysteine,
- the organic nitrogen content,
- any additives^[SEP]
- the instructions for use^[SEP]
- the batch number as well as the expiry date and storage conditions such as temperature, humidity and aeration conditions^[SEP]
- the indication that the inactivated yeasts come from genetically engineered yeasts, and the modified character if this is the case.

3. CHARACTERISTICS

They are most often in the form of granules, powder or flakes, of light yellow to yellow ochre, with a smell characteristic of yeast.^[SEP]Inactivated yeasts with guaranteed GSH levels are partially soluble in water, with the insoluble part being greater or equal to 60% m/m of the dry matter.

4. LIMITS AND TRIAL METHODS

4.1 - Oxidised glutathione (GSSG) content

The level of oxidised form of glutathione, glutathione disulphide (GSSG) that is the only identified form according to the state of our knowledge, is measured by the HPLC method described in Annex 1.

4.1.1 Preparation of the solution for testing

Precisely weigh 2 g IDY and place in a 20-mL centrifuge tube, add 1 mL glass beads of 425-600 microns and 4 mL pH 7.5 phosphate buffer solution.

Vortex for 20 min at 4 °C then centrifuge a minimum of 12,000 g for 20 min at 4 °C.

The supernatant is the solution for testing, which is to be kept in the dark at 4 °C for 4 hrs maximum before determination.

The ratio between reduced glutathione and oxidised glutathione should be higher than 3.

4.2 - Reduced glutathione (GSH), Cysteine and gamma-glutamylcysteine content

The reduced glutathione, cysteine and gamma-glutamylcysteine levels are measured by the HPLC method after derivatisation described in Annex 4.

- The reduced glutathione content should be greater than 1%, or 10 mg/g IDY
- The endogenous cysteine content should be lower than 0.3%, or 3 mg/g IDY,
- the gamma-glutamylcysteine content should be lower than 1%, or 10 mg/g IDY.

4.3 - Nitrogen content

4.3.1 The total nitrogen content, expressed as element N, is less than 10% of the dry matter, according to the method of analysis described in Chapter II of the *International Oenological Codex*, being referred to as N_t

4.3.2 The ammoniacal nitrogen content, expressed as element N, must be less than 0.5% of the dry matter and is determined according to the method of analysis described in **Annex 2**, being referred to as N_a

4.3.3 The organic nitrogen content is obtained by the difference between the total nitrogen content and the ammoniacal nitrogen content:

Organic nitrogen = $N_t - N_a$

4.3.4 The small peptide and free and soluble amino acid content should be less than 10% of the dry matter in glycine equivalent, according to the DNFB method described in Annex 3, or 1.9% of the dry matter expressed as element N.

4.4 - Humidity

This is measured by the 5 g loss in product weight, dried at 105 °C to constant weight (around 3 hours). The maximum content should be less than 7%.

4.5 - Lead

Proceed with an analysis according to the method that appears in Chapter II of the *International Oenological Codex*.
The content should be less than 2 mg/kg of the dry matter.

4.6 - Mercury

Proceed with an analysis according to the method that appears in Chapter II of the *International Oenological Codex*.
The content should be less than 1 mg/kg of the dry matter.

4.7 - Arsenic

Proceed with an analysis according to the method that appears in Chapter II of the *International Oenological Codex*.
The content should be less than 3 mg/kg of the dry matter.

4.8 - Cadmium

Proceed with an analysis according to the method that appears in Chapter II of the *International Oenological Codex*.
The content should be less than 1 mg/kg of the dry matter.

4.9 - Viable yeasts

Proceed with counting according to the method that appears in Chapter II of the *International Oenological Codex*.
The number should be less than or equal to 10^2 CFU/g of the dry matter.

4.10 - Mould

Proceed with counting according to the method that appears in Chapter II of the *International Oenological Codex*.
The number should be less than 10^3 CFU/g of the dry matter.

4.11 - Lactic acid bacteria

Proceed with counting according to the method that appears in Chapter II of the *International Oenological Codex*.
The number should be less than 10^3 CFU/g of the dry matter.

4.12 - Acetic bacteria

Proceed with counting according to the method that appears in Chapter II of the *International Oenological Codex*.
The number should be less than 10^3 CFU/g of the dry matter.

4.13 - Salmonella

Proceed with counting according to the method that appears in Chapter II of the *International Oenological Codex*.
Absence should be checked on a 25 g sample of the dry matter.

4.14 - Escherichia coli

Proceed with counting according to the method that appears in Chapter II of the *International Oenological Codex*.
Absence should be checked on a 1 g sample of the dry matter.

4.15 - Staphylococci

Proceed with counting according to the method that appears in Chapter II of the *International Oenological Codex*.

Absence should be checked on a 1 g sample of the dry matter.

4.16 - Coliforms

Proceed with counting according to the method that appears in Chapter II of the *International Oenological Codex*.
The number should be less than 10^2 CFU/g of the dry matter.

5. ADDITIVES

These should be compliant with the regulations in force.

6. PRESERVATION

Do not store in open packaging. The inactivated yeasts with guaranteed glutathione levels should always be kept in sealed sachets without air contact. Store in a cool, dry place. Follow the manufacturer's instructions at all times. Storage under unappropriated conditions might lead to the decrease of the reduced glutathione content.

Annex 1

Determination of reduced and oxidised glutathione by HPLC

This determination is carried out according to the method for the determination of glutathione in pharmaceutical preparations by Soliman *et al.* (2014).

1. Scope of application

This method makes it possible to determine the reduced glutathione and oxidised glutathione or glutathione disulphide (GSSG) levels within a concentration range of 0-100 mg/L of preparation for analysis.

2. Principle

The method used employs high-performance liquid chromatography according to the reverse-phase principle (column C18) with detection by spectrophotometry using diode-array apparatus of 200-400 nm.

3. Products and reagents

3.1 List of products

3.1.1 Glutathione (GSH, > 98%)

3.1.2 Methanol (HPLC-grade purity)

3.1.3 Formic acid (purity > 98%)

3.1.4 Ultra-pure water with resistivity of >18 MΩ.cm at 25°C temperature.

3.2 Mobile phase

The mobile phase is constituted of ultra-pure water (3.1.4) containing 0.1% of the formic-acid mixture (3.1.3) and methanol (3.1.2) in proportions of 90:10, v/v.

4. Equipment

4.1 High-performance liquid chromatography apparatus

-
- 4.2 Diode-array spectrophotometer
4.3 Data-acquisition apparatus
4.4 Octadecyl-type column of dimensions 150 mm x 2 mm and with a 3- μ m diameter (by way of example)
4.5 230- μ L Loop injector
4.6 System for degassing of solvents (ultrasonic)
4.7 System for filtration of samples on a membrane with pores of 0.45 μ m in diameter.

5. Preparation of samples

5.1 The sample containing the glutathione to be determined is prepared by dilution of the solution for testing (point 4.1.1 of the monograph) in the mobile phase (3.2) in order to obtain a final concentration of around 20 mg/L.

5.2 The samples are filtered on a membrane (4.7) before injection.

6. Procedure

Analysis is conducted at room temperature, in isocratic mode with a mobile-phase flow rate of 0.5 mL/min.

Detection is carried out in "scan" mode at 200-400 nm.

7. Results

Under these analytical conditions, reduced glutathione (GSH) is well separated from oxidised glutathione (GSSG). This method consequently allows both forms of glutathione to be determined.

Under these analytical conditions, the retention time of glutathione is 7.5 min and that of oxidised glutathione is 9.5 min.

8. Method characteristics

Each concentration is calculated by averaging the three determinations obtained by using the regression line of the calibration curve. The results are expressed in mg/L.

The linear regression and correlation coefficient are calculated according to the least-squares method.

Linearity

The linear range is 0-100 mg/L and the R correlation coefficient = 0.9998.

Precision

The method precision was evaluated based on 3 analyses of glutathione at 1.0, 50.0 and 100.0 mg/L, conducted within the same day and also on 3 different days.

Table 1: Characteristics of the method for the determination of reduced glutathione based on the recovery rates

GSH concentration (mg/L)	Daily precision		Precision over 3 days	
	% recovery, SD	% CV	% recovery, SD	% CV
1	99.88 ± 0.68	0.68	99.76 ± 1.89	1.89
50	100.04 ± 0.39	0.39	100.09 ± 0.73	0.73
100	99.93 ± 0.57	0.57	99.85 ± 0.86	0.86

Scope of application

According to the determinations carried out, the method is applicable for concentrations of 0-100 mg/L.

The limits of detection and quantification of glutathione established according to the guidelines of the International Conference on Harmonisation (ICH) (3.3 and 10 times the standard deviation of the blank [7 analyses] divided by the slope of the calibration curve) are 20 µg/L (LoD) and 68 µg/L (LoQ) respectively.

9. Bibliography

Soliman, R. M., Hadad, G. M., Abdel Salam, R.A., Mesbah, M. K., 'Quantitative determination of glutathione in presence of its degradant in a pharmaceutical preparation using HPLC-DAD and identification by LC-ESI-MS', *J. Liquid Chromatography and related technologies*, 37, 2014, pp. 548-559.

Annex 2**Determination of ammoniacal nitrogen****1. Reagents**

1.1 Potassium chloride (0.5 M KCl)

Dissolve 18.64 g KCl in 500 mL pure, demineralised water.

1.2 30% Sodium hydroxide

Place 30 g sodium hydroxide in a 100-mL flask, add 70 mL pure, demineralised water, stir until dissolved and make up to 100 mL.

1.3 4% Boric acid (R)

See R part II of the *International Oenological Codex*.

1.4 0.1 M Hydrochloric acid for titration (solution ready for market use)

1.5 Mixed indicator of methyl red and methylene blue

See R part II of the *International Oenological Codex*.

2. Equipment

2.1 Laboratory glassware

2.2 Steam distillation apparatus as described in Chapter II of the *International Oenological Codex* for the determination of total nitrogen.

3. Determination

3.1 Place 1 g of the dry matter of the inactivated yeasts in 100 mL 0.5 M KCl (1.1) and mix for 20-30 min.

3.2 Introduce the 100 mL into the steam distillation apparatus (2.2) with 50 mL 30% sodium hydroxide (R).^{[1][2]}

3.3 Distil by collecting 250 mL in a conical flask containing 5 mL 4% boric acid (1.3), 10 mL water and 2-3 drops of mixed indicator of methyl red and methylene blue (1.5).

Titrate the distillate using 0.1 M hydrochloric acid (1.4) up to the purple-pink bend of the indicator.

1 mL hydrochloric acid solution corresponds to 1.4 mg nitrogen (N).

Where n is the number of mL poured:

100 g IDY contain 0.14 n g ammoniacal nitrogen expressed as element N, namely N_a .

Annex 3

Amino nitrogen method

1. Introduction

This method makes it possible to quickly determine the amino nitrogen in a biological solution compared with a calibration range produced with glycine solution.

2. Scope of application

Oenological products of plant or animal origin.

3. Definition

Dinitrofluorobenzene or DNFB reacts with the free NH_2 groups contained in the amino acids in order to give a compound with a bright yellow colour determined by 420-nm colorimetry. The reaction takes place at a $\text{pH} > 9.3$.

4. Reagents and products

Reagents:

4.1 borax or sodium tetraborate,

4.2 dinitrofluorobenzene (be careful of hazards while handling DNB),

4.3 10 M hydrochloric acid,

4.4 glycine, purity \geq 98%, [SEP]

4.5 ethanol 95% vol.

5. Apparatus

5.1 Haemolysis tubes,

5.2 micropipettes,

5.3 spectrophotometer for measurements in the visible region,

5.4 60 °C water bath. [SEP]

6. Preparation of samples

6.1 Prepare a 5% sodium tetraborate solution in pure water, [SEP]

6.2 prepare a DNFB solution: introduce 130 μ L DNFB in 10 mL ethanol of 95% vol. [SEP]

6.3 prepare a 2 M hydrochloric acid solution, [SEP]

6.4 create a calibration range from a 2 g/L glycine stock solution (M=75.07 g) e.g. 0.50 mg/L, 100 mg/L, 200 mg/L, 500 mg/L, [SEP]

6.5 prepare a 2 g/L suspension of the product to be determined, centrifuge for 30 min and recover the supernatant.

7. Procedure

- Introduce the following into a haemolysis tube:

380 μ L 5% borax (6.1),

[SEP] 20 μ L sample to be determined (6.5),

20 μ L DNFB solution (6.2),

- do the same for the glycine range,

mix and place the water bath at 60 °C for 30 min (5.4),

add 3 mL 2M HCl (6.3),

mix and read the specific absorbance at 420 nm for the sample (5.3),

produce a calibration range with the glycine range (6.4). [SEP]

8. Results

[SEP] Record the absorbance value of the sample at 420 nm on the calibration curve. The results are expressed in g glycine/L.

Annex 4**Determination of reduced glutathione, cysteine and gamma-glutamylcysteine by HPLC after derivatisation****PREAMBULE**

The principle is to determine, by HPLC/UPLC-UV using a reverse-phase column, amino acids and thiol peptides after derivatisation of this function. This method is suitable for complex matrices of yeasts and yeast derivatives.

1. Scope of application

This method allows for the determination of reduced glutathione (GSH), cysteine (Cys) and gamma-glutamylcysteine (GluCys) within the following concentration ranges:

- 2-24 mg/L for the GSH and GluCys compounds,
- 0.5-6 mg/L for Cys.

2. Principle

The method used employs high-performance liquid chromatography according to the reverse-phase principle (column C18) with detection by spectrophotometry at 320 nm.

3. Products and reagents**3.1 Products**

- 3.1.1 GSH: glutathione, CAS no. 70-18-8 (purity > 98%)

3.1.2 Cys.HCl.H₂O: L-cysteine hydrochloride monohydrate, CAS no. 7048-04-6 (purity >

98%)

3.1.3 GluCys: γ -L-glutamyl-L-cysteine, CAS no. 636-58-8 (purity > 80%)

3.1.4 Sodium dihydrogen phosphate (NaH₂PO₄·H₂O), pure

3.1.5 Sodium acetate anhydrous, pure

3.1.6 17.4 M Acetic acid, pure

3.1.7 Methanol (HPLC-grade purity)

3.1.8 Concentrated phosphoric acid (purity > 98%)

3.1.9 Ultra-pure water of resistivity >18 M Ω .cm at a temperature of 25°C

3.1.10 Acetonitrile, pure

3.1.11 2,2'-Dithiobis(5-nitropyridine) (DNTP), CAS no. 2127-10-8 (purity > 96%)

3.1.12 Concentrated trichloroacetic acid solution (25-30%)

3.2 Acetate buffer (used for derivatisation)

- Weigh 8.1 g sodium acetate (3.1.5), dissolve into 100 mL ultra-pure water (3.1.9),
- adjust the pH to 6.3 with acetic acid (3.1.6) (around 100-200 μ L),
- make up to 1 L with ultra-pure water (3.1.9).

3.3 2,2'-Dithiobis(5-nitropyridine) (DNTP) reagent (to be prepared just before use)

-
- Weigh 30 mg DNTP (3.1.11) and dissolve in 10 mL acetonitrile (3.1.10).

3.4 Trichloroacetic acid at 5.7%

- Dissolve 19 g trichloroacetic acid at 30% (3.1.12) in 100 mL ultra-pure water (3.1.9).

3.5 Mobile phase

- **Eluent A:** weigh 3.4g NaH₂PO₄·H₂O (3.1.4), dissolve in 898 g ultra-pure water (3.1.9), add 79 g methanol (3.1.7), and adjust the pH from 4.45 to 2.5 by addition of concentrated phosphoric acid (3.1.8; around 0.8-1 mL).
- **Eluent B:** methanol (3.1.7).

4. Equipment

4.1 High-performance liquid chromatography apparatus

4.2 Spectrophotometer with detection at 320 nm

4.3 Data-acquisition apparatus

4.4 Octadecyl-type column with dimensions of 250 mm x 4.6 mm with a phase diameter of 5 µm (e.g. RP Supelcosil ABZ+Plus; Waters XTerra RP18 or equivalent)

4.5 Loop injector

4.6 System of degassing of solvents (ultrasound)

4.7 Sample filtration system on a membrane with 0.45-µm pore diameter

4.8 Magnetic stirrer

4.9 Centrifuge

4.10 pH meter

4.11 Everyday laboratory glassware

5. Preparation of samples

5.1 Preparation of standards

5.1.1 GSH solution at ~400 mg/L

In a 200- mL flask, dissolve ~80 mg GSH (3.1.1) weighed **exactly**, and make up to 200 mL using ultra-pure water (3.1.9).

5.1.2 GluCys solution at ~400 mg/L

In a 50- mL flask, dissolve ~20 mg GluCys (3.1.3) weighed **exactly**, and make up to 50 mL using ultra-pure water (3.1.9).

5.1.3 Cys.HCl.H₂O solution at ~100 mg/L

In a 100- mL flask, dissolve ~130 mg Cys,HCl.H₂O (3.1.2) weighed **exactly**, make up to 100 mL using ultra-pure water (3.1.9), then dilute to 1:10 with ultra-pure water (3.1.9).

5.2 Preparation of samples

The test portion (TP) of the sample should be adapted so that the concentration is within the calibration range, i.e. between 2 and 24 mg/L GSH. For inactivated dry yeast (IDY) with guaranteed GSH levels, take a sample in advance according to the following protocol:

- weigh ~1g IDY **exactly**, add 17.5 mL trichloroacetic acid at 5.7% (3.4),
- mix for 20 min at room temperature (4.8),

-
- adjust to 50 mL (=V) with ultra-pure water (3.1.9),
 - centrifuge for 10 min at 5500 rpm (4.9).

6. Derivatisation

- Carry out in test tubes based on the preparations in 5.1, according to the following table.
- Mix by inverting the tubes.

The reaction is complete in 5 minutes. The different solutions are analysed by HPLC after filtration (4.7).

INTERNATIONAL OENOLOGICAL CODEX

Inactivated yeasts (glutathione)

COEI-1-LEVGLU: 2018

							In duplicate
		Standard 1	Standard 2	Standard 3	Standard 4	Standard 5	Test
		GSH and <u>GluCys</u> : 2 mg/L	GSH and <u>GluCys</u> : 4 mg/L	GSH and <u>GluCys</u> : 8 mg/L	GSH and <u>GluCys</u> : 16 mg/L	GSH and <u>GluCys</u> : 24 mg/L	
		<u>Cys</u> : 0.5 mg/L	<u>Cys</u> : 1 mg/L	<u>Cys</u> : 2 mg/L	<u>Cys</u> : 4 mg/L	<u>Cys</u> : 12 mg/L	
Acetate buffer (mL)		8.85	8.7	8.4	7.8	7.2	
Standard solution (µL)	GSH (400 mg/L)	50	100	200	400	600	
	<u>Cys</u> (100 mg/L)	50	100	200	400	600	
	<u>GluCys</u> (400 mg/L)	50	100	200	400	600	
Sample (µL)							1000
DNTP (µL)	1000						

Important note: Consider adapting the test portion according to the colouration. Verify that the tests fall within the range.

7. Chromatographic conditions

Column temperature: 30 °C

Sample temperature: 5 °C

Mobile-phase flow rate: 1 mL/min

Injection volume: 5 μ LPressure: 140-175·10³ hPa (around 2000-2500 psi)

Detection: 320 nm

Duration of analysis: 34 min

Equilibration limit at the end of analysis:
10 min

Rinsing: water

Storage: water / methanol 80:20 v/v

Time after injection (min)	% eluent A	% eluent B
	100	0
1	100	0
23	40	60
28	0	100
32	0	100
34	100	0

8. Calibration curves

For each analyte, establish calibration curves C (mg/L) = $f[A]$ considering the following:

- the concentrations in mg/L for Cys, GSH and GluCys,

-
- the factor of dilution,
 - the areas obtained.

Important note: For Cys, **take into consideration the HCl:** PE (g/L)

* $M_{\text{pure Cys}}$ (121.16 g/mol) / $M_{\text{Cys,HCl.H}_2\text{O}}$ (175.63 g/mol).

Calculations of concentrations:

- In terms of dry matter (DM):

$$\text{g/100g DM} = \frac{\text{Area}}{\text{slope}} \times \frac{V (=50\text{ml})}{PE (g)} \times \frac{1}{10 \times DM}$$

- In terms of the product as it is:

$$\text{g/100g} = \frac{\text{Area}}{\text{slope}} \times \frac{V (=50\text{ml})}{PE (g)} \times \frac{1}{1000}$$

9. Bibliography

- Rahman et al., Nature Protocols 1, 2007, pp. 3159-3165.
- Katrusiac et al., 'Pre-column derivatization high-performance liquid chromatographic method for determination of cysteine, cysteinyl-glycine, homocysteine and glutathione in plasma and cell extracts', Journal of chromatography B: Biomedical Sciences and Applications, Vol. 758, No. 2, 2001, pp. 207-212.
- Raju N. Appala et al., 'A Simple HPLC-UV Method for the Determination of Glutathione in PC-12 Cells', Scientifica, Vol. 2016 (2016).

L(+) TARTARIC ACID
L-2,3-dihydroxybutanedioic acid
Dextrorotatory tartaric acid
Acidum tartaricum
COOH - CHOH - CHOH - COOH
C₄H₆O₆ = 150.1
SIN NO. 334
OENO 49/2000
OENO 4/2007

1. OBJECTIVE, ORIGIN AND SCOPE OF APPLICATION

This is a natural acid extracted from grapes. It is used to acidify musts and wines under conditions stipulated by regulation.

2. LABELING

The label should indicate in a clear manner that the product is L-tartaric acid, sometimes written L(+)tartaric acid, since its rotatory power is positive. It must also indicate the purity percentage (greater than 99.5%) and storage requirements.

3. PROPERTIES

Very solid colorless, transparent crystals which have a distinctly acidic flavor and containing no water of crystallization.

Melting point is 170 °C.

4. SOLUBILITY

Water at 20 °C	highly soluble
Alcohol, 95% by vol.	379 g/l
Glycerol	soluble
Ethyl ether	very slightly soluble

5. ROTATORY POWER

In an aqueous solution of 20 g per 100 ml
20°C

$[\alpha]_D$ is between +11.5 and +13.5°.

D

Specific rotatory power varies greatly with temperature and pH.

6. IDENTIFYING CHARACTERISTICS

6.1. Verify total solubility in water. A 1% solution exhibits an acidic reaction in the presence of methyl orange (R)

6.2. Place 2 ml of concentrated sulfuric acid (R), 2 drops of sulforesorcinic reagent (R) and a very small crystal of tartaric acid (1-5 mg) in a test tube. Heat to 150 °C. An intense violet coloration should appear.

6.3. Add 2 ml of 5 pp 100 potassium acetate solution (R) to 5 ml of 10 pp 100 solution (m/v). A crystallized precipitate should form immediately.

6.4. Place 5 ml chloroform or dichloromethane in a test tube. Add 100-200 mg tartaric acid. Shake. Crystals should gather at the bottom of the tube. Under these conditions, citric acid crystals will collect at the liquid surface.

7. TESTS

7.1. Foreign Matter

Tartaric acid should be soluble without residue in its weight of water and in 4 times its weight of alcohol at 95% by volume.

7.2. Sulfur Ash

As explained in the annex, use a precisely-weighed sample of approximately 2 g to determine sulfur ash concentration in the tartaric acid. This sulfuric ash concentration must not be greater than 1 g/kg.

7.3. Preparing the Solution for Tests

Dissolve 10 g of tartaric acid in a quantity of water sufficient to produce 100 ml of solution.

7.4. Chlorides

Add 14.5 ml of water, 5 ml of nitric acid diluted to 10 pp 100 (R), and 0.5 ml of 5 pp 100 silver nitrate solution (R) to 0.5 ml of the solution prepared for tests under Paragraph 7.3. After 15 minutes of sitting in the dark, there should be no clouding ; or else, any clouding that does appear should be less intense than that observed in a control prepared as indicated in the annex. (Chloride content expressed in terms of hydrochloric acid should be less than 1 g/kg).

7.5. Sulfates

Add 18 ml of water, 1 ml of hydrochloric acid diluted to 10 pp 100 (R), and 2 ml of 10 pp 100 barium chloride solution (R) to 1 ml of the solution prepared for tests under Paragraph 7.3. After 15 minutes of sitting in the dark, there should be no clouding, ;or else, any clouding that does appear should be less intense than that observed in a control prepared as indicated in the annex. (Sulfate content expressed in terms of sulfuric acid should be less than 1 g/kg).

7.6. Citric Acid

Add 5 ml of water and 2 ml of mercury (II) sulfate solution (R) to 5 ml of the solution prepared for tests under paragraph 7.3. Bring to a boil and add several drops of 2 pp 100 potassium permanganate solution (R). No white precipitate should form.

7.7. Oxalic Acid and Barium (test)

Neutralize 5 ml of test solution prepared under Paragraph 7.3 by adding ammonium hydroxide. Add 2 drops of acetic acid (R) and 5 ml of a saturate calcium sulfate solution (R).The solution should remain clear. (Opalescence may appear by virtue of the precipitation of calcium oxalate or barium sulfate.)

7.8. Oxalic Acid (quantitative analysis)

If the test conducted under 7.7 is positive, perform quantitative analysis of the oxalic acid.

Using the method described in the annex, determine oxalic acid content in the test solution (6.3). (Content expressed for oxalic acid should be less than 100 mg/kg after dessiccation).

7.9. Iron

Add 1 ml of concentrated hydrochloric acid (R) and 2 ml of 5 pp 100 potassium thiocyanate solution (R) to 10 ml of the solution prepared for tests under Paragraph 7.3. The resulting red coloration should be less intense than that observed in a control prepared using 1 ml of an iron (III) salt solution having a concentration of 0.010 g of iron per liter, 9 ml of water and the same quantities of the same reagents. (Iron content should be less than 10 mg/kg).

It is also possible to determine iron content by atomic absorption spectrometry, using the technique detailed in the Compendium.

7.10. Lead

Using the technique in the Appendix, determine the lead content in the test solution (7.3). (Lead content should be less than 5 mg/kg).

7.11. Mercury

Using the technique described in the Annex, determine the proportion of mercury in the test solution (7.3). (Mercury content should be less than 1 mg/kg).

7.12. Arsenic

Using the technique described in the Annex, determine the proportion of arsenic in the test solution (7.3). (Arsenic content should be less than 3 mg/kg).

8. QUANTITATIVE ANALYSIS

In 10 ml water, dissolve a precisely-weighed test sample **p** weighing about 1 g L-tartaric acid. Titrate with a 1 M sodium hydroxide solution (R) in the presence of phenolphthalein (R). Let **n** be the number of milliliters used.

1 ml 1 M sodium hydroxide solution corresponds to 0.075 g L-tartaric acid.

Content in percent of L-tartaric acid of the product assayed :

$$7.5 \mathbf{n}.$$

The product used for wine-making must contain at least 99.5 pp 100 L-tartaric acid (dry product).

9. STORAGE

L-tartaric acid should be stored in hermetically sealed containers.

L-LACTIC ACID, D-LACTIC ACID, D,L-LACTIC ACID**2-hydroxypropanoic acid****N° SIN : 270****C.A.S. number 50-21-5****(L-: 79-33-4; D-: 10326-41-7; DL-: 598-82-3)****chemical formula C₃H₆O₃****Molecular mass: 90.08, density 1.20-1.21.**

OENO 29/2004

OENO 4/2007

1. OBJECT, ORIGIN AND FIELD OF APPLICATION

An acid of natural origin obtained by lactic fermentation of sugars or synthetically made; it may contain condensation products such as lactate from lactic acid and dilactide.

It is used for the acidification of musts and wines in the conditions set by the regulation.

2. LABELLING

The label must mention particularly clearly that it concerns L-lactic or D-Lactic acids obtained by fermentation or D,L-Lactic obtained by a chemical process, the storage conditions and expiration date.

The common commercial products are solutions at 50%-90%.

Solid products containing about 100%-125% of titrable lactic acid also exist. (Note: Lactic acid is hygroscopic and once concentrated by boiling or distillation, it forms condensation products that hydrolyse into lactic acid by dilution and by heating in water).

Purity level: not less than 95.0% and not more than 105.0% of the concentration marked.

3. CHARACTERISTICS

Colourless or slightly yellow and syrupy liquid with a clearly acid flavour to a slightly lactic taste.

4. SOLUBILITY

Water at 20°C: very soluble

Alcohol at 95% vol.: Very soluble

Ether: very soluble

Insoluble in chloroform.

5. OPTICAL ROTATION

For L-lactic acid aqueous solution at 2.5 g for 100 ml.

$\alpha_{21-22^{\circ}\text{C}}^D$ is 2.6°

For D-lactic acid in aqueous solution at 8 g for 100 ml.

α ^D_{21-22°C} is -2.6°

6. IDENTITY CHARACTERS

6.1 Characterisation of lactic acid

In a 100 ml conical flask, weigh 10 g of lactic acid, add 5 ml of sulphuric acid 0.5 M, shake, add 25 ml of potassium permanganate at 0.33% and place on a hot plate. Collect the vapour released on a filter paper soaked with a solution at 50% vol/vol of morpholine at 20% and potassium nitrocyanoferate (II) at 5%.

The filter paper becomes blue.

6.2 Determination of total lactic acid

Titrate the free lactic acid with sodium hydroxide 1 M then hydrolyse the polymerised lactic acid using an excess of sodium hydroxide and then determined by sulphuric acid 0.5 M.

6.3 Colour

Compare the colour with the standards of the alpha scale (colour standards of platinum-cobalt).

6.4 Stereochemical purity

The method is based on the separation by HPLC using a chiral phase of two enantiomers of lactic acid. The product is diluted in water beforehand. Enzymatic determinations can also be performed according to the methods in the Compendium of international methods of analysis of wines and musts.

7. TEST TRIALS

7.1 Preparation of the test trial solution

For the purity test trials, prepare a solution containing 10% m/v of lactic acid by using the concentration marked.

7.2 Sulphuric ashes

From a 2 g sample of lactic acid, determine the sulphuric ashes as indicated in chapter II of the International Oenological Codex.

The content must be less than or equal to 1 g/kg.

7.3 Chlorides

To 0.5 ml of the test trial solution (7.1), add 14.5 ml of water, 5 ml of diluted nitric acid (R) and 0.5 ml of silver nitrate solution at 5% (R). The solution should satisfy for the test trial, the determination limit of chlorides described in chapter II of the International Oenological Codex.

The chloride content must be less than 1 g/kg expressed in hydrochloric acid.

7.4 Iron

To 10 ml of the test trial solution (7.1), add 1 ml of concentrated hydrochloric acid (R) and 2 ml of the potassium thiocyanate solution at 5% (R). The red colouration obtained must not be darker than the control prepared with 1 ml of the iron salt solution (III) at 0.010 g of iron per litre (R), 9 ml of water and the same quantities of the same reagents.

The iron content must be less than 10 mg/kg.

Iron can also be determined by atomic absorption spectrometry according to the method described in chapter II of the International Oenological Codex.

7.5 Lead

Using the test trial solution (7.1), apply the method described in chapter II of the International Oenological Codex.

Lead content should be less than 2 mg/kg.

7.6 Mercury

Using the test trial solution (7.1), determine the mercury according to the method described in chapter II of the International Oenological Codex.

Mercury content should be less than 1 mg/kg.

7.7 Cadmium

Using the test trial solution (7.1), determine the cadmium according to the method described in chapter II of the International Oenological Codex.

Cadmium content should be less than 1mg/kg.

7.8 Arsenic

Using the test trial solution (7.1), determine the arsenic according to the method described in chapter II of the International Oenological Codex.

Arsenic content should be less than 3 mg/kg.

7.9 Sulphates

To 1 ml of the test trial solution (7.1), add 18 ml of water, 1 ml of diluted hydrochloric acid at 10% (R) and 2 ml of barium chloride solution at 10% (R). The solution should satisfy for the test trial, the determination limit of sulphates described in chapter II of the International Oenological Codex.

Sulphate content should be less than 1 g/kg, expressed in sulphuric acid.

7.10 Cyanides

In a 40 ml volumetric flask containing 25 ml of distilled water and 2.5 ml of buffer solution at pH 7.5 (R), introduce 0.4 ml of the test trial

solution (7.1), add 0.3 ml of chloramine T solution at 0.1% (R). Wait 90 seconds and add 6 ml of pyridine-pyrazolone reagent (R). Complete to 40 ml with distilled water and mix. The colouration obtained must not be darker than that obtained by treating the same way 4 ml of a freshly prepared potassium cyanide solution titrating 1 mg of hydrocyanic acid per litre (R).

Free cyanide content expressed in hydrocyanic acid should be less than 1 mg/kg.

7.11 Citric acid

To 5 ml of the test trial solution (7.1), add 5 ml of water, 2 ml of mercury sulphate solution (II) (R), bring to the boil and add a few drops to the potassium permanganate solution at 2% (R). No white precipitate should form.

7.12 Citric, oxalic, tartaric and phosphoric acids

Dilute 1 ml of the test trial solution (7.1) in 10 ml of water, add 40 ml of the calcium hydroxide solution (R) bring to the boil for 2 minutes. No turbidity should form.

7.13 Sugars

Add 2 ml of the test trial solution (7.1) to 10 ml of cupro-alkaline reagent (R). No red precipitate should form.

8. STORAGE

Lactic acid should be stored in hermetically sealed containers away from heat and light.

LIQUID SULFUR DIOXIDE
Liquid sulfurous anhydride
Sulfuris dioxydum solutum
SO₂ = 64.07
SIN NO. 220
OENO 46/2000

1. OBJECTIVE, ORIGIN AND SCOPE OF APPLICATION

Sulfur dioxide is a colorless, non-flammable gas with a sharp, suffocating odor. It is stored and transported in liquid form in hardened steel tanks. These solutions are not stable and should not contain less than 50 g/l SO₂.

At a temperature of 20 °C, it is liquid under a pressure of 3.36 kg per square centimeter, or 3.30 bars.

Under standard pressure, its boiling point is -10 °C. Its density is $\rho_{20} = 1.383$.

This product falls under the category of antiseptic and antioxidant preservatives. Its content level in wine is subject to the regulatory limits in force concerning quantities.

2. LABELING

The label should indicate product SO₂ content at the time of sale and its safety and storage conditions.

3. SOLUBILITY

Water at 0 °C 79.79 l of sulfur dioxide per liter of water at standard pressure

Water at 20 °C 39.37 l of sulfur dioxide per liter of water at standard pressure

Alcohol, 95% by vol. at 20 °C : 114.48 l of sulfur dioxide per liter of water
Hydrocarbons, fatty substances and other organic compounds : soluble

4. IDENTIFYING PROPERTIES

4.1. Sulfur dioxide blackens a filter paper which is impregnated with mercury (I) nitrate.

4.2. Sulfur dioxide turns a filter paper impregnated with potassium iodine and starch solution blue. Then, the blue color disappears because of reduction of the iodine initially released.

4.3. Sulfur dioxide has a strong, characteristic odor.

5. TESTS

5.1. Non-volatile Substances

In a 500 ml container that has already been calibrated, collect 200 ml of liquid sulfur dioxide. Weigh the container immediately afterward. Let **p** be the mass in g sampled. Let the sulfur dioxide spontaneously evaporate. After reheating the container and removing any gaseous sulfur dioxide it still contains, weigh the container which holds the residue from evaporation. The mass of this residue should be less than 0.01 pp 100.

5.2. Preparing the Solution for Tests

Add 2 ml of concentrated nitric acid (R) and 5 ml of water to the residue left by evaporating 200 ml of sulfur dioxide (5.1). Place in a 100 °C water bath for 5 minutes. The remaining volume should be topped off with water to 200 ml.

5.3. Copper

Take a sample which corresponds to 1 g of liquid sulfur dioxide from the test solution prepared under paragraph 5.2. Top off to 10 ml with distilled water and add 0.5 ml of 10 pp 100 (v/v) hydrochloric acid solution, 15 pp 100 (m/v) citric acid (R), 1 ml of 5M ammonium hydroxide solution (R) and 0.5 ml of 1 pp 100 sodium diethyldithiocarbamate solution (concentration : 1 pp 100) in alcohol at 40% by volume (R). If a yellow coloration appears, it should be less intense than that obtained by adding 1 ml of copper solution in a concentration of 0.01 g per liter (R), 9 ml of water, 0.5 ml of 10 pp 100 (v/v) hydrochloric acid solution, 15 pp 100 (m/v) citric acid (R), 1 ml of 5M ammonium hydroxide solution (R) and 0.5 ml of 1 pp 100 sodium diethyldithiocarbamate solution (concentration : 1 pp 100) in alcohol at 40% by volume (R). (Copper content should be less than 10 mg/kg).

5.4. Iron

Take a sample of the solution prepared for tests under paragraph 5.2 corresponding to 1 g of liquid sulfur dioxide. Top off to 5 ml with water. Add 1 ml of concentrated hydrochloric acid (R), one drop of 1 pp 100 potassium permanganate (R) and 5 ml of 5 pp 100 potassium thiocyanate solution. If a red coloration appears, it should be less intense than that obtained by a control prepared with 5 ml of iron solution in a concentration of 0.010 g of iron per liter (R) and the same

quantities of hydrochloric acid and thiocyanate. (Iron content should be less than 50 mg/kg).

Iron may also be quantitatively analyzed using the atomic absorption spectrophotometry method detailed in the Compendium.

5.5. Lead

In the test solution prepared under paragraph 5.2, determine the lead content using the method described in the Compendium. (Lead content should be less than 5 mg/kg). It is also possible to dose iron using the atomic photometry method described in the Annex.

Lead may also be quantitatively analyzed using the atomic absorption spectrophotometry method detailed in the Compendium.

5.6. Mercury

Using the technique described in the annex, determine mercury concentration in the test solution (5.2). (Content should be less than 1 mg/kg.)

5.7. Selenium

In a test tube, take a volume of the solution prepared for tests under paragraph 5.2 corresponding to 1.5 g of sulfur dioxide and top off to 2 ml with water. Add 8 ml of hydrochloric acid diluted to 30 pp 100 (R) and 50 mg of powdered anhydrous potassium sulfite (R) which has been verified to be selenium free. After dissolving, place the test tube in a 100 °C water bath. Examine the color in the tube after 15 minutes.

If a pink coloration appears, it should not be more intense than that obtained in a control prepared by adding 0.15 ml selenium dioxide solution in a concentration of 100 mg selenium per liter (R), 1.85 ml of water, 8 ml of 30 pp 100 hydrochloric acid (R) and 50 mg of powdered, selenium-free anhydrous potassium sulfite and, after dissolving, by placing the test tube in a 100 °C water bath for 15 minutes. (Selenium content should be less than 10 mg/kg).

5.8. Arsenic

Using the technique described in the annex, determine arsenic concentration in the test solution (5.2). Concentration should be less than 3 mg/kg.

6. STORAGE

Sulfur dioxide should be stored and delivered in a liquid state in metal cylinders equipped with a needle valve tap or slide valve and whose strength is checked regularly. Keep the containers in a cool place.

LYSOZYME

Muramidase

N°SIN: 1105 (enzyme 3.2.1.17)

OENO 15/2001;

OENO 4/2007

1. OBJECT, ORIGIN AND FIELD OF APPLICATION

Lysozyme (Chlorhydrate and Lysozyme) is an edible egg white extract from hens. It is used to inhibit bacterial growth and can be used in musts and wine. Doses are limited in level.

Lysozymes contain no substances, micro-organisms or collateral enzyme activities, which are:

- harmful to the health,
- harmful for the quality of the products treated,
- lead to the formation of undesirable products or favour acts of fraud.

2. LABELLING

The concentration of the product must be indicated on the label, in addition to the security conditions, the preservation and the expiration date.

3. COMPOSITION

Lysozyme is a natural polypeptide made up of 129 amino acids, out of which there are 21 aspartic acids, 5 glutamic acids, 12 alanines, 11 arginines, 8 cystines, 3 phenylalanines, 12 glycines, 6 isoleucines, 1 histidine, 8 leucines, 6 lysines, 2 prolines, 2 methionines, 10 serines, 3 tyrosines, 7 threonines, 6 tryptophanes and 6 valines.

The molecular mass of lysozyme is 14,700 Daltons.

The water content must be less than or equal to 6%.

4. CHARACTERISTICS

Lysozyme can be in crystal powder form, white, odourless with a mild taste.

5. SOLUBILITY

Lysozyme is soluble in water and insoluble in organic solvents.

6. IDENTIFYING CHARACTERISTICS

A 2% aqueous solution must have a pH between 3.0 and 3.6. An aqueous solution containing 25-mg/100 ml has a maximum absorption of 281 nm and a minimum of 252 nm.

7. ENZYME ACTIVITY

Enzyme activity is capable of hydrolysing a link between N-acetylmuramic acid and N-acetylglucosamine of gram positive bacteria cell walls. The minimum concentration for lysozyme is 95%. There is no secondary enzyme activity.

8. ENZYME ORIGIN AND MEANS OF PRODUCTION

Enzyme is extracted from edible hen egg white by a procedure of separating ion-exchange resin.

The microbiological purity guarantees the security for its usage in food. The egg white used in the preparation of enzymes are compatible with parameters established by inspection agencies and is treated in compliance with hygienic manufacturing procedures.

9. SUBSTANCES USED AS DILUENTS, PRESERVATIVES, AND ADDITIVES

There are no substances used as preservatives as the crystalline form guarantees the stability.

10. TRIAL TESTS

10.1 Sulphuric ashes

As indicated in the appendix, the sulphuric ash content of lysozyme should not exceed 1.5%.

10.2 Total nitrogen

Evaluated according to the procedure outlined in the appendix, nitrogen content should be between 16.8 and 17.8% on dry matter.

10.3 Preparation of test trials solution

Dissolve 5 g of lysozyme in 100 ml of water.

10.4 Heavy Metals

Add 2 ml of pH 3.5 solution (R) and 1.2 ml of reactive thioacetamide (R) to 10 ml of prepared test trial solution (10.3). There should be no precipitate. If a brown colour is produced, it should be less than the sample produced as indicated in the appendix. (Heavy metal content measured in lead should be under 10 mg/kg).

10.5 Arsenic

Look for arsenic using the procedure in the appendix on 2 ml of test trial solution (10.3). (Arsenic content under 1 mg/kg).

10.6 Lead

Measure out lead following the procedure in the Compendium on the test trial solution (10.3). (Lead content under 2 mg/kg.)

10.7 Mercury

Measure out mercury following the procedure in the appendix on the test trial solution (10.3). (Mercury content under 1 mg/kg).

10.8 Biological Contaminants

Evaluation carried out according to procedure in the appendix.

Total bacteria	under 10^3 CFU per g of preparation
Coliforms	maximum 10 per g of preparation
Escherichia coli	absence checked on 1 g sample
St. aureus	absence checked on 1 g sample
<i>Salmonella</i>	absence checked on 25 g sample
Yeasts	content limit 10^2 CFU per g of preparation
Total lactic bacteria	content limit : absence checked on a 10 g sample preparation
Acetic bacteria	content limit 10^2 CFU per g of preparation
Mould	content limit 10^2 CFU per g of preparation.

11. MEASURING TURBIDITY OF LYSOZYME ACTIVITY IN WINE

(Turbidimetric measuring)

11.1 Principle

The analytical procedure was established by FIP (1997) with some modifications made by FORDRAS. The procedure is based on changes in turbidity changes in *Micrococcus luteus* ATCC 4678 induced by a lytic lysozyme activity.

Under normal test conditions, the above-mentioned changes are in proportion to the quantity of lysozyme.

11.2 Substrate

Do not use an electromagnetic mixer when suspending between 40 – 60 mg of *Micrococcus luteus* ATCC 4698 (Boehringer) in powder form in phosphate solution M/15 pH 6.6 (± 0.1), when obtaining a homogeneous suspension and complete it with 100 ml with the same buffer. Use a hand mixer or an ultrasound bath.

The exact quantity of *Micrococcus luteus* to be taken depends on the spectrophotometer used.

Prepare a control sample with 5 ml of buffer and 5 ml of *Micrococcus luteus* and measure the absorbency with the aid of a 540 nm spectrophotometers compared to control sample of phosphate buffer. Absorbency should not be under 0.800.

If reading the measurement doesn't correspond, the content of *Micrococcus luteus* must be adapted in the suspension and then measure the desired absorbency.

Note: With a sensitive spectrophotometer, the absorbency levels of above-mentioned solutions are 0.800 to 0.900. Equipment that are not as sensitive may give readings for the absorbency for this same suspension of 0.500 to 0.600.

In this case, we should not increase the amount of substrate to obtain initial absorbency rates of 0.800 to 0.900, because reproducing the measurement linearity are not very dependable.

11.3 Preparation of standard solution

11.3.1. Dissolve exactly 50 mg of lysozyme chlorhydrate in water, and fill up to 100 ml in a graduated flask.

11.3.2. Dilute 5 ml of solution in 11.3.1 with water up to 50 ml.

11.3.3. Dilute 2 ml of this solution with a M/15 phosphate buffer up to 100 ml to obtain a 1 mg/l of lysozyme (standard solution).

11.4 A solution to analyse

Dilute the sample of wine with m/15 phosphate buffer to obtain the same concentration of standard solution (1 mg/l) in relation with the concentration of lysozyme.

11.5 Procedure

Prepare the following solutions in 180 x 80 mm test tubes

Standard solution to analyse	Buffer M/15	Lysozyme concentration
2.0 ml	3.0 ml	0.4 mg/l
2.8 ml	2.2 ml	0.56 mg/l
4.0 ml	1.0 ml	0.8 mg/l

It is recommended to repeat each dilution 3 times for the standard solution and for the solution to be tested.

Prepare two test tubes with 5 ml of buffer as a suspension control sample for *Micrococcus luteus*. Use the first control sample in the beginning and the second one at the end of the trial.

After exactly 30 seconds, add 5 ml of *Micrococcus luteus* suspension. This must be mixed manually to avoid over spilling. Mix with a Vortex and keep the tubes in 37°C (\pm 5°C) water for exactly 12 minutes.

The final quantity of lysozyme in the tubes will be 0.2 – 0.28 – 0.4 mg/l.

After incubation, remove the tubes in the same order they were placed in, with an interval of 30 seconds.

Mix and take a reading of the absorbency with the 540 nm spectrophotometer for white wine and 740nm for the red wine against the control buffer.

Under normal circumstances, the test trial is acceptable when the difference between the absorbency rates for the control samples is under 5%.

11.6 Calculation

Prepare a standard curve indicating the average values of absorbency obtained for each standard solution on the y-axis. On the x-axis put the concentrations of lysozyme on a logarithm scale.

Carry over the results obtained for the dilutions to be analysed.

Draw two straight lines: one between the points obtained from the standard solution and the other between the points of the solution to be analysed. The two lines must be parallel, if not the dose is incorrect.

Then draw a line parallel to the x-axis so that the two right lines are cut about halfway the extreme limit for dosing.

In the two intersection points, which correspond to two concentrations on the x-axis (C_{st} concentration of the standard curve and C_x concentration of the curve for the solution to be analysed). The activity is calculated as follows:

$$\text{Concentration of lysozyme } (\mu\text{g/ml}) = = \frac{C_{st} \times D}{C_x}$$

Where

C_{st} = concentration of the standard solution

C_x = concentration of the solution to be analysed

D = dilution factor

12. DETERMINATION OF LYSOZYME IN WINE

(Determination by HPLC)

The lysozyme residue can be determined by HPLC according to the method described in the Compendium on International Analysis Methods of Wines and Musts.

13. PRESERVATION

Lysozyme must be stored at room temperature in a closed sealed container, away from humidity.

14. BIBLIOGRAPHY

FIP (1997), Pharmaceutical Enzymes, A. Lowers and S. Scharpe ed. 1997, vol.84 pages 375-379.

L-MALIC ACID, DL-MALIC ACID
2-hydroxybutanedioic acid
N° SIN: 296
C.A.S. number 617-48-1
Chemical formula C₄H₆O₅
Molecular mass: 134.09
OENO 30/2004

1. OBJECT, ORIGIN AND FIELD OF APPLICATION

An acid of natural origin contained in most fruit (L-malic acid) or synthetically made: DL-malic.

It is used for the acidification of musts and wines in the conditions set by the regulation.

2. LABELLING

The label must mention particularly clearly that it is L-malic or D,L-malic acid, the storage conditions and date of expiry.

Malic acid content should be at least 99%.

3. CHARACTERISTICS

White or off-white crystalline powder or granules with a clearly acid flavour.

Melting point of D,L-malic: 127°C-132°C

Melting point of L-malic: 100°C.

4. SOLUBILITY

Water at 20°C: 55.8 g/100

Alcohol at 95% vol.: 45.5 g/100.

Ether: 0.84 g/ 100

5. OPTICAL ROTATION

For the L-Malic acid in aqueous solution at 8.5 g for 100 ml.

$\alpha_{20^{\circ}C}^D$ is - 2.3°

6. IDENTITY CHARACTERS

6.1 Characterisation of malic acid

Malic acid can be determined by an enzymatic process according to the methods in the Compendium of international methods of analysis of wines and musts (specifically L-malic and D-malic acids. Malic acid can also be determined by HPLC according to the method in the Compendium of international methods of analysis of wines and musts.

7. TEST TRIALS**7.1 Preparation of the test trial solution**

For purity trials, prepare a solution containing 10% m/v of malic acid.

7.2 Sulphuric cinders

From a 2 g sample of malic acid, determine the sulphuric cinders as indicated in chapter II of the International Oenological Codex.

Content must be less than or equal to 1 g/kg.

7.3 Chlorides

To 0.5 ml of the test trial solution (7.1), add 14.5 ml of water, 5 ml of diluted nitric acid (R) and 0.5 ml of silver nitrate solution at 5% (R). The solution should satisfy for the test trial, the determination limit of chlorides described in chapter II of the International Oenological Codex.

Content must be less than 1 g/kg expressed in hydrochloric acid.

7.4 Iron

To 10 ml of the test trial solution (7.1), add 1 ml of concentrated hydrochloric acid (R) and 2 ml of potassium thiocyanate solution at 5% (R). The red colouration obtained should not be darker than that of the control prepared with 1 ml of an iron salt solution (III) at 0.010 g of iron per litre (R), 9 ml of water and the same quantities of the same reagents.

Content must be less than 10 mg/kg.

Iron can also be determined by atomic absorption spectrometry according to the method described in chapter II of the International Oenological Codex.

7.5 Lead

Using the test trial solution (7.1), apply the method described in chapter II of the International Oenological Codex.

Lead content must be less than 5 mg/kg.

7.6 Mercury

Using the test trial solution (7.1), determine the mercury according to the method described in chapter II of the International Oenological Codex.

Mercury content must be less than 1 mg/kg.

7.7 Cadmium

Using the test trial solution (7.1), determine the cadmium according to the method described in chapter II of the International Oenological Codex.

Cadmium content must be less than 1 mg/kg.

7.8 Arsenic

Using the test trial solution (7.1), determine the arsenic according to the method described in chapter II of the International Oenological Codex.

Arsenic content must be less than 3 mg/kg.

7.9 Sulphates

To 1 ml of the test trial solution (7.1), add 18 ml of water, 1 ml of diluted hydrochloric acid at 10% (R) and 2 ml of the barium chloride solution at 10% (R). The solution should satisfy for the test trial, the determination limit of sulphates described in chapter II of the International Oenological Codex. Sulphates content must be less than 1 g/kg, expressed in sulphuric acid.

7.10 Cyanides

In a 40 ml volumetric flask containing 25 ml of distilled water and 2.5 ml of buffer solution at pH 7.5 (R), introduce 0.4 ml of the test trial solution (7.1), add 0.3 ml of chloramine T solution at 0.1% (R). Wait 90 seconds and add 6 ml of pyridine-pyrazolone reagent (R). Complete to 40 ml with distilled water and mix. The colouration obtained must not be darker than that obtained by treating the same way 4 ml of a freshly prepared potassium cyanide solution titrating 1 mg of hydrocyanic acid per litre (R).

Free cyanide content expressed in hydrocyanic acid must be less than 1 mg/kg.

7.11 Sugars

Add 2 ml of the test trial solution (7.1) to 10 ml of cupro-alkaline reagent (R). No red precipitate should form.

7.12 Fumaric and maleic acids

Limit in fumaric acid: 1% in weight.

Limit in maleic acid: 0.05% in weight. These acids are determined by HPLC according to the method described in the Method of Analysis of Wines and Musts in the same way as malic and tartaric acids.

8. STORAGE

Malic acid should be stored in hermetically sealed containers away from heat and light.

METATARTARIC ACID**Ditartaric acid*****Acidum ditartaricum*****SIN NO. 353**

OENO 31/2000

1. OBJECTIVE, ORIGIN AND SCOPE OF APPLICATION

The name metatartaric acid applies to the product obtained by dehydrating L-tartaric acid at a temperature of 150-170 °C under atmospheric pressure or under a reduced pressure.

This product can retard tartaric precipitation in the bottle.

Its effectiveness in preventing tartaric precipitation is directly related to the rate of esterification

The quantity in which it is used in wines is restricted.

The primary constituents of the product are the ditartaric monoester and diester in variable proportions based on the combination of two molecules of tartaric acid with water loss, mixed with variable quantities of non-esterified tartaric acid, pyruvic acid and small quantities of poorly known polyester acids.

This product exists in crystalline masses or in powder form with a white or greater or lesser yellowish color. It has a faint odor of toast or caramel and is very deliquescent.

It is highly soluble in water and alcohol and rapidly hydrolyzed in aqueous solution at 100 °C, but much more slowly at cold temperatures.

2. LABELING

The label should indicate the esterification rate and safety and storage conditions, as well as the optimal expiration date.

3. DETERMINATION

3.1. Place a sample of 1-10 mg of this substance in a test tube with 2 ml of concentrated sulfuric acid (R) and 2 drops of sulforesorcinic reagent (R). When heated to 150 °C, an intense violet coloration appears.

3.2. Place 2.50 ml of 10 pp 100 (m/v) tartaric acid in 20 alcohol by volume in a 100 ml cylindrical flask. Add 10 mg of metatartaric acid (0.5 ml of 2% solution), 40 ml of water and 1 ml of 25 pp 100 calcium acetate solution (R). Stir. A weak, amorphous precipitate remaining in suspension will appear for certain samples having a high ester number

when they contain a small quantity of poorly known polyesters. No crystallized precipitate should form within 24 hours, whereas a mixture of the same reagents without metatartaric acid yields a crystallized precipitate within several minutes.

4. TESTS

4.1. Appearance

A 10 pp 100 aqueous solution of metatartaric acid should be clear and almost colorless or slightly amber in color.

4.2. Preparation of the Test Solution

Prepare a metatartaric acid solution in a concentration of 20 g/l in water.

4.3. Quantitative Analysis

Place 50 ml of very recently prepared 2 pp 100 solution (1 g of metatartaric acid) in a 250 ml conical flask. Add 3 drops of bromothymol blue solution (R) in a concentration of 4 g/l and 1 M sodium hydroxide solution until the indicator turns bluish-green. Let n be the number of ml used.

Add 20 ml of 1M sodium hydroxide. Insert the stopper and let sit for 2 hours at ambient temperature. Titrate the excess alkaline solution using 0.5M sulfuric acid. Let n' be the number of millimeters used: 1 ml of 1M sodium hydroxide corresponds to 0.075 g of tartaric acid.

Content (pp 100 of total free and esterified acid) of the tested product:

$$7.5 (n + 20 - n')$$

Ester content pp 100 of total acid functions:

$$100 (20 - n') / (n + 20 - n')$$

The wine-making product must contain at least 105 pp 100 total tartaric acid after hydrolysis and 32 pp 100 esterified acid.

4.4. Heavy Metals

Using the thioacetamide technique described in the annex, determine heavy metals content in the test solution prepared in accordance with Par. 4.2 (when expressed for lead, the heavy metals content must be lower than 10 mg/kg).

4.5. Lead

Using the technique described in the Compendium, quantify the proportion of lead in the test solution (Par. 4.2). (Lead content should be less than 5 mg/kg).

4.6. Mercury

Using the technique described in the annex, determine the proportion of mercury in the test solution prepared in accordance with Par. 4.2 (content must be lower then 1 mg/kg).

4.7. Arsenic

Using the technique described in the annex, determine arsenic content in the test solution prepared in accordance with Par. 4.2 (content must be lower then 3 mg/kg).

5. STORAGE

Metatartaric acid should be stored in hermetically sealed containers away from air and moisture.

MICROCRISTALLINE CELLULOSE

(C₁₂ H₂₀ O₁₀)_n

INS N°: 460

OENO 9/2002

1. OBJECT. ORIGIN AND FIELD OF APPLICATION

Microcrystalline cellulose is purified cellulose and is partially depolymerised. It comes from the treatment of alpha-cellulose mineral acids from plant fibres. Its molecular weight is approximately 36 000. Microcrystalline cellulose plays an important role in "supporting" very clarified fermentation as it increases the fermentability of the juices.

2. LABELLING

The concentration of the product must be mentioned on the label and if there is mixing as well as the method of preservation.

3. CHARACTERISTICS

Cellulose is found in **microcrystalline powder form**, white, odourless and tasteless. It is almost insoluble in water, acetone, ethanol, toluene, diluted acids and in 50 g/l sodium hydroxide solutions.

4. IDENTIFICATION

4.1 In a watch glass, put approximately 10 mg of microcrystalline cellulose and add 2 ml of zinc chloride iodated solution (R). The solution turns bluish purple.

4.2 Degree of polymerisation

Put 1.300 g of microcrystalline cellulose in a 125 ml conical flask. Add 25 ml of water (R) and 25 ml of 1M cupriethylenediamine hydroxide. Immediately pass a nitrogen current. Close the flask and mix until completely dissolved. Pour 7 ml of the solution into an appropriate glass capillary viscosimetric tube.

Time how long it takes between two lines on the viscosimeter and express the time measured in t_1 . Calculate the kinematic viscosity V_1 of the solution using the following formula:

$$V_1 = t_1(k_1)$$

In which k_1 is the viscosimeter constant.

Take out an appropriate volume of 1M cupriethylenediamine hydroxide and dilute with the same volume of water. (R). Using an appropriate capillary viscosimeter, determine the time flow of this solution.

Calculate the kinematics viscosity V_2 of the solvent using the following formula:

$$V_2 = t_2(k_2)$$

In which k_2 is the viscosimeter constant.

Determine the relative viscosity η_{rel} of the microcrystalline cellulose sample, using the following formula:

$$V_1/V_2$$

Determine the intrinsic viscosity $[\eta]c$ by extrapolation, using the intrinsic viscosity table in Annex.

Calculate the degree of polymerisation P, using the formula:

$$P = 95[\eta]c/m[(100-b)/100]$$

In which m is the mass, in grams of the trial and b is the value obtained in the test trial " loss through drying " in %.

The degree of polymerisation is not over 350.

4.3 pH

Shake for 20 minutes about 5 g of cellulose in 40 ml of water free of carbon dioxide. Centrifuge. The pH of the supernatant liquid must be between 5.0 and 7.5.

4.4 Soluble substances in ether

Prepare a column of 10.0 g of microcrystalline cellulose in a glass tube with an inside diameter of approximately 20 mm. Put 50 ml of ether free of peroxides (R). through the column and evaporate the eluate until bone dry. The residue should not be above 5.0 mg (0.05%).

4.5 Soluble substances in water

Mix 5.0 g of microcrystalline cellulose with 80 ml of water (R) for 10 mn. Filter in a vacuum and collect the filtrate in a weighed vase. Evaporate over a bath of 100° C water until bone dry and dry at 100-105°C for 1 hour. The residue is not above 12.5 mg (0.25%).

4.6 Starch

Add 90 ml of water (R) to 10 g microcrystalline cellulose. and boil for 5 mn. Filter when hot. Let cool and add 0.1 ml iodine 0.05 M to filtrate. There is no blue colouring.

4.7 Loss through drying

Put 1 g of cellulose in a mass capsule for 3 hours in an incubator at 100-105°C. Loss through drying should not be more than 6.0%.

All limits set below refer to the dried product.

4.8 Ashes

Incinerate at $600 \pm 25^\circ\text{C}$ the residue obtained in point 4.7. for 4 hours. The mass of the ashes should not be more than 0.1%.

4.9 Preparation of test solution

After weighing. dissolve the ashes in 2 ml of concentrated hydrochloric acid (R) and 10 ml of water (R). Heat to activate the dissolution and fill up to 50 ml with water.

4.10 Iron

Determine iron with an atomic absorption spectrophotometer following the method described in Chapter II into the test solution (4.9).

Iron content must be less than less or equal to 10 mg/kg.

4.11 Lead

Determine the lead according to the method described in Chapter II. into the test solution (4.9).

Lead content must be less than 5 mg/kg.

4.12 Mercury

Determine the mercury according to the method described in Chapter II

Mercury content must be less than 1 mg/kg.

4.13 Cadmium

Determine the cadmium according to the method described in Chapter II. into the test solution (4.9).

Cadmium content must be less than 1 mg/kg.

4.14 Arsenic

Determine the arsenic according to the method described in Chapter II.

Arsenic content must be less than 1 mg/kg.

4.15 Calcium

Determine the calcium with an atomic absorption spectrophotometer. following the method described in Chapter II. into the test solution (4.9).

Calcium content must be less than 500 mg/kg.

5. STORING CONDITIONS

Cellulose must be stored in a well-ventilated place in sealed packages away from volatile substances which it might adsorb.

INTERNATIONAL TECHNOLOGICAL CODEX

TABLE OF INTRINSIC VISCOSITY

Intrinsic viscosity, $[\eta]_c$, according to value of relative viscosity.. η_{rel}

$[\eta]_c$

η_{rel}	0.00	0.01	0.02	0.03	0.04	0.05	0.06	0.07	0.08	0.09
1.1	0.098	0.106	0.115	0.125	0.134	0.143	0.152	0.161	0.170	0.180
1.2	0.189	0.198	0.207	0.216	0.225	0.233	0.242	0.250	0.259	0.268
1.3	0.276	0.285	0.293	0.302	0.310	0.318	0.326	0.334	0.342	0.350
1.4	0.358	0.367	0.375	0.383	0.391	0.399	0.407	0.414	0.422	0.430
1.5	0.437	0.445	0.453	0.460	0.468	0.476	0.484	0.491	0.499	0.507
1.6	0.515	0.522	0.529	0.536	0.544	0.551	0.558	0.566	0.573	0.580
1.7	0.587	0.595	0.602	0.608	0.615	0.622	0.629	0.636	0.642	0.649
1.8	0.656	0.663	0.670	0.677	0.683	0.690	0.697	0.704	0.710	0.717
1.9	0.723	0.730	0.736	0.743	0.749	0.756	0.762	0.769	0.775	0.782
2.0	0.788	0.795	0.802	0.809	0.815	0.821	0.827	0.833	0.840	0.846
2.1	0.852	0.858	0.864	0.870	0.876	0.882	0.888	0.894	0.900	0.906
2.2	0.912	0.918	0.924	0.929	0.935	0.941	0.948	0.953	0.959	0.965
2.3	0.971	0.976	0.983	0.988	0.994	1.000	1.006	1.011	1.017	1.022
2.4	1.028	1.033	1.039	1.044	1.050	1.056	1.061	1.067	1.072	1.078
2.5	1.083	1.089	1.094	1.100	1.105	1.111	1.116	1.121	1.126	1.131
2.6	1.137	1.142	1.147	1.153	1.158	1.163	1.169	1.174	1.179	1.184
2.7	1.190	1.195	1.200	1.205	1.210	1.215	1.220	1.225	1.230	1.235
2.8	1.240	1.245	1.250	1.255	1.260	1.265	1.270	1.275	1.280	1.285
2.9	1.290	1.295	1.300	1.305	1.310	1.314	1.319	1.324	1.329	1.333
3.0	1.338	1.343	1.348	1.352	1.357	1.362	1.367	1.371	1.376	1.381
3.1	1.386	1.390	1.395	1.400	1.405	1.409	1.414	1.418	1.423	1.427
3.2	1.432	1.436	1.441	1.446	1.450	1.455	1.459	1.464	1.468	1.473
3.3	1.477	1.482	1.486	1.491	1.496	1.500	1.504	1.508	1.513	1.517
3.4	1.521	1.525	1.529	1.533	1.537	1.542	1.546	1.550	1.554	1.558
3.5	1.562	1.566	1.570	1.575	1.579	1.583	1.587	1.591	1.595	1.600
3.6	1.604	1.608	1.612	1.617	1.621	1.625	1.629	1.633	1.637	1.642
3.7	1.646	1.650	1.654	1.658	1.662	1.666	1.671	1.675	1.679	1.683
3.8	1.687	1.691	1.695	1.700	1.704	1.708	1.712	1.715	1.719	1.723
3.9	1.727	1.731	1.735	1.739	1.742	1.746	1.750	1.754	1.758	1.762

INTERNATIONAL CENOLOGICAL CODEX

Microcristalline Cellulose

COEI-1-CELMIC: 2002

4.0	1.765	1.769	1.773	1.777	1.781	1.785	1.789	1.792	1.796	1.800
4.1	1.804	1.808	1.811	1.815	1.819	1.822	1.826	1.830	1.833	1.837
4.2	1.841	1.845	1.848	1.852	1.856	1.859	1.863	1.867	1.870	1.874
4.3	1.878	1.882	1.885	1.889	1.893	1.896	1.900	1.904	1.907	1.911
4.4	1.914	1.918	1.921	1.925	1.929	1.932	1.936	1.939	1.943	1.946
4.5	1.950	1.954	1.957	1.961	1.964	1.968	1.971	1.975	1.979	1.982
4.6	1.986	1.989	1.993	1.996	2.000	2.003	2.007	2.010	2.013	2.017
4.7	2.020	2.023	2.027	2.030	2.033	2.037	2.040	2.043	2.047	2.050
4.8	2.053	2.057	2.060	2.063	2.067	2.070	2.073	2.077	2.080	2.083
4.9	2.087	2.090	2.093	2.097	2.100	2.103	2.107	2.110	2.113	2.116
5.0	2.119	2.122	2.125	2.129	2.132	2.135	2.139	2.142	2.145	2.148
5.1	2.151	2.154	2.158	2.160	2.164	2.167	2.170	2.173	2.176	2.180
5.2	2.183	2.186	2.190	2.192	2.195	2.197	2.200	2.203	2.206	2.209
5.3	2.212	2.215	2.218	2.221	2.224	2.227	2.230	2.233	2.236	2.240
5.4	2.243	2.246	2.249	2.252	2.255	2.258	2.261	2.264	2.267	2.270
5.5	2.273	2.276	2.279	2.282	2.285	2.288	2.291	2.294	2.297	2.300
5.6	2.303	2.306	2.309	2.312	2.315	2.318	2.320	2.324	2.326	2.329
5.7	2.332	2.335	2.338	2.341	2.344	2.347	2.350	2.353	2.355	2.358
5.8	2.361	2.364	2.367	2.370	2.373	2.376	2.379	2.382	2.384	2.387
5.9	2.390	2.393	2.396	2.400	2.403	2.405	2.408	2.411	2.414	2.417
6.0	2.419	2.422	2.425	2.428	2.431	2.433	2.436	2.439	2.442	2.444
6.1	2.447	2.450	2.453	2.456	2.458	2.461	2.464	2.467	2.470	2.472
6.2	2.475	2.478	2.481	2.483	2.486	2.489	2.492	2.494	2.497	2.500
6.3	2.503	2.505	2.508	2.511	2.513	2.516	2.518	2.52 1	2.524	2.526
6.4	2.529	2.532	2.534	2.537	2.540	2.542	2.545	2.547	2.550	2.553
6.5	2.555	2.558	2.561	2.563	2.566	2.568	2.571	2.574	2.576	2.579
6.6	2.581	2.584	2.587	2.590	2.592	2.595	2.597	2.600	2.603	2.605
6.7	2.608	2.610	2.613	2.615	2.618	2.620	2.623	2.625	2.627	2.630
6.8	2.633	2.635	2.637	2.640	2.643	2.645	2.648	2.650	2.653	2.655
6.9	2.658	2.660	2.663	2.665	2.668	2.670	2.673	2.675	2.678	2.680
7.0	2.683	2.685	2.687	2.690	2.693	2.695	2.698	2.700	2.702	2.705
7.1	2.707	2.710	2.712	2.714	2.717	2.719	2.721	2.724	2.726	2.729
7.2	2.731	2.733	2.736	2.738	2.740	2.743	2.745	2.748	2.750	2.752
7.3	2.755	2.757	2.760	2.762	2.764	2.767	2.769	2.771	2.774	2.776
7.4	2.779	2.781	2.783	2.786	2.788	2.790	2.793	2.795	2.798	2.800
7.5	2.802	2.805	2.807	2.809	2.812	2.814	2.816	2.819	2.821	2.823
7.6	2.826	2.828	2.830	2.833	2.835	2.837	2.840	2.842	2.844	2.847
7.7	2.849	2.851	2.854	2.856	2.858	2.860	2.863	2.865	2.868	2.870
7.8	2.873	2.875	2.877	2.879	2.881	2.884	2.887	2.889	2.891	2.893

INTERNATIONAL CENOLOGICAL CODEX**Microcrystalline Cellulose**

COEI-1-CELMIC: 2002

7.9	2.895	2.898	2.900	2.902	2.905	2.907	2.909	2.911	2.913	2.915
-----	-------	-------	-------	-------	-------	-------	-------	-------	-------	-------

8.0	2.918	2.920	2.922	2.924	2.926	2.928	2.931	2.933	2.935	2.937
8.1	2.939	2.942	2.944	2.946	2.948	2.950	2.952	2.955	2.957	2.959
8.2	2.961	2.963	2.966	2.968	2.970	2.972	2.974	2.976	2.979	2.981
8.3	2.983	2.985	2.987	2.990	2.992	2.994	2.996	2.998	3.000	3.002
8.4	3.004	3.006	3.008	3.010	3.012	3.015	3.017	3.019	3.021	3.023
8.5	3.025	3.027	3.029	3.031	3.033	3.035	3.037	3.040	3.042	3.044
8.6	3.046	3.048	3.050	3.052	3.054	3.056	3.058	3.060	3.062	3.064
8.7	3.067	3.069	3.071	3.073	3.075	3.077	3.079	3.081	3.083	3.085
8.8	3.087	3.089	3.092	3.094	3.096	3.098	3.100	3.102	3.104	3.106
8.9	3.108	3.110	3.112	3.114	3.116	3.118	3.120	3.122	3.124	3.126
9.0	3.128	3.130	3.132	3.134	3.136	3.138	3.140	3.142	3.144	3.146
9.1	3.148	3.150	3.152	3.154	3.156	3.158	3.160	3.162	3.164	3.166
9.2	3.168	3.170	3.172	3.174	3.176	3.178	3.180	3.182	3.184	3.186
9.3	3.188	3.190	3.192	3.194	3.196	3.198	3.200	3.202	3.204	3.206
9.4	3.208	3.210	3.212	3.214	3.215	3.217	3.219	3.221	3.223	3.225
9.5	3.227	3.229	3.231	3.233	3.235	3.237	3.239	3.241	3.242	3.244
9.6	3.246	3.248	3.250	3.252	3.254	3.256	3.258	3.260	3.262	3.264
9.7	3.266	3.268	3.269	3.271	3.273	3.275	3.277	3.279	3.281	3.283
9.8	3.285	3.287	3.289	3.291	3.293	3.295	3.297	3.298	3.300	3.302
9.9	3.304	3.305	3.307	3.309	3.311	3.313	3.316	3.318	3.320	3.321
10	3.32	3.34	3.36	3.37	3.39	3.41	3.43	3.45	3.46	3.48
11	3.50	3.52	3.53	3.55	3.56	3.58	3.60	3.61	3.63	3.64
12	3.66	3.68	3.69	3.71	3.72	3.74	3.76	3.77	3.79	3.80
13	3.80	3.83	3.85	3.86	3.88	3.89	3.90	3.92	3.93	3.95
14	3.96	3.97	3.99	4.00	4.02	4.03	4.04	4.06	4.07	4.09
15	4.10	4.11	4.13	4.14	4.15	4.17	4.18	4.19	4.20	4.22
16	4.23	4.24	4.25	4.27	4.28	4.29	4.30	4.31	4.33	4.34
17	4.35	4.36	4.37	4.38	4.39	4.41	4.42	4.43	4.44	4.45
18	4.46	4.47	4.48	4.49	4.50	4.52	4.53	4.54	4.55	4.56
19	4.57	4.58	4.59	4.60	4.61	4.62	4.63	4.64	4.65	4.66

NANOFILTRATION MEMBRANES

OIV-OENO 482-2013

1. OBJECT, ORIGIN AND SCOPE OF APPLICATION

Membranes belonging to the family of semi-permeable membranes, these can be homogenous or composite membranes and are generally organic; they may have a spiralled or "spiral-wound", flat sheet or "frame and plate", tubular or hollow fibre configuration.

Nanofiltration is a membrane technique under pressure that covers a separation scope between reverse osmosis and ultrafiltration, enabling the separation of molecules in solution at less than approximately 2 nm. Most of the membrane materials used in nanofiltration have surface charges that play a part in the separation of ionic species, thus the selective retention of multivalent ions compared with monovalent ions can be obtained.

Generally, the MWCO (Molecular Weight Cut Off) of separation for organic compounds varies from 150 to 500 g·mol⁻¹ (150 to 500 daltons) to a maximum of 2000 g·mol⁻¹ (2000 daltons).

The transfer selectivity of the solutes through the membrane is generally expressed by their retention rate (= [1- (final conc. / initial conc.)] x 100).

2. PROCEDURE PRINCIPLE

This is a physical method of removing a portion of the solvents (water and alcohol) and very low molecular weight compounds from the must or wine (close to the cut off) using a semi-permeable membrane driven by a pressure gradient at ambient temperature and without changing or altering its state.

The process is carried out as a tangential flow.

The apparatus may consist, for example, of a high pressure pump (e.g. from 2 to 8·10⁴ Pa or 20 to 80 bars) used to overcome the osmotic pressure, a membrane block and monitoring equipment, such as a flowmeter, pressure indicator and controller, etc.

3. COMPOSITION

All the equipment used in the procedure conforms with regulations relating to equipment in contact with food (pipes, pumps, monitoring equipment, joints, etc.).

These membranes are usually prepared through *in situ* polymerisation of a polymer on the surface of a porous substrate. The thin layer serves as the discriminating membrane, while the porous substrate acts as the physical support.

For example, the main organic polymers used may include cellulose acetate and polyamide, etc.

As an example, the structural formula of the polyamide base is as follows:

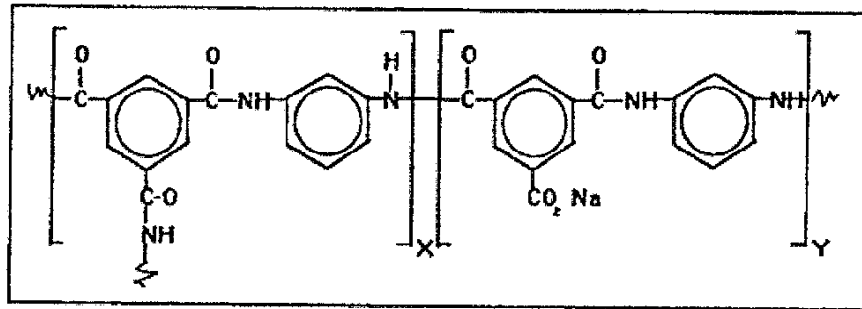

4. LABELLING

The main characteristics should be indicated on the label, particularly the batch number.

5. MANUFACTURE

Through a number of procedures, it is possible to obtain a whole range of pore sizes, from tangential microfiltration to the dense membrane of reverse osmosis.

The final characteristics (thickness, porosity, pore size, internal structure) of the membrane depend on a great number of parameters (choice of ternary solvent/polymer/non-solvent, composition of collodion, addition of porogenes, operating conditions - temperature, casting speed, diameter/thickness of the collodion, etc.)

6. MEMBRANE CLEANING

The user may use inorganic products authorised according to regulations, provided that the operation ends by rinsing with water so as to completely remove the cleaning product before adding the must or wine.

7. LIMITS

- All the equipment in contact with food products must comply with the standards in force.
 - There should be no noticeable change in the organoleptic characteristics of the processed must or wine.
- Any potential release of the product or derivative comprising the membrane must comply with the current specific migration standards for the various constituents of the equipment.

8. SPECIAL RESTRICTIONS

The membrane must meet the regulatory requirements for equipment in contact with food.

NITROGEN
Nitrogenum
N = 14.007
SIN NO. 941
OENO 19/2000

1. OBJECTIVE, ORIGIN AND SCOPE OF APPLICATION

Neutral gas used to render inert or to degas. It can be used pure or mixed with carbon dioxide.

2. LABELING

The label should mention the nature of this gas and reference its composition and purity, as well as its safety and storage conditions.

3. PROPERTIES

Colorless, odorless, flavorless gas. It is not flammable and does not maintain combustion.

The weight of a liter of nitrogen under normal conditions is 1.250 g. Under a pressure of 760 mm of mercury at 20 °C, a volume of water dissolves a 0.01507 volume of nitrogen, while a volume of alcohol dissolves a 0.1224 volume of nitrogen.

4. TESTS

The purity of nitrogen used for oenological purposes should be 99 parts per 100 by volume.

Before undertaking any measurement, the gas should be allowed to escape for several moments in order to clean out the lines.

Gas detection and quantitative analysis: oxygen, carbon monoxide, argon, carbon dioxide, etc. are most rapidly detected using gas phase chromatography. (See this method in the Annex.)

The following chemical methods can also be used.

4.1. Phosphorous-containing Hydrogen, Arsenical Hydrogen and Reducing Substances

Let 1 liter of nitrogen to flow into a mixture of 10 ml of ammoniacal silver nitrate (R) and 15 ml of water.

Regulate the flow of gas so that the gas flows into the solution in approximately 15 minutes.

There should be no clouding or brown coloration when compared with an identical control solution through which no gas will flow.

4.2. Oxygen

Prepare a flask to test for oxygen as follows:

Place 2 turned pieces of copper of approximately 2 cm², 16 ml of ammoniacal copper sulfate solution (R) and 2 ml of hydrazine dichlorhydrate in a 24 ml flask.

Stop the flask with a rubber stopper which can easily be pierced with a hypodermic needle. Seal the collar with a metal cap, then cover the cap with wax to ensure a perfectly airtight seal. Shake the flask, then let it sit in the dark until the color disappears completely, after approximately eight days.

Conducting the test:

Pierce the flask stopper with a 8/10 mm hypodermic needle (take care not to dip the needle into the liquid). This will allow gas to escape after bubbling. Next, insert a second hypodermic needle of the same diameter and plunge it into the liquid. After a minute of bubbling, there should be no significant coloring. In the presence of oxygen, the liquid will rapidly turn blue and the color becomes more intense over time.

The nitrogen must incorporate less than 10 ml/l oxygen.

5. PACKING AND STORAGE

Nitrogen is delivered in high-strength steel canisters which are painted black and equipped with a needle valve tap. The strength of the canisters should be checked periodically.

OENOLOGICAL TANNINS**INS N°: 181**

OENO 12/2002;

OENO 5/2008;

OENO 6/2008;

OIV/OENO 352/2009;

OIV-OENO 554-2015;

OIV-OENO 574-2017;

OIV-OENO 624-2022

1. GENERAL STATEMENTS

Oenological tannins contain polyphenols. Their complex structure is generally made up of a great variety of monomer units that are covalently bound to each other.

These are derived from different parts of plant species and extracted using solvents permitted under current regulations. They are classified into two classes according to the nature of the monomeric units that characterise them: hydrolysable tannins and condensed tannins *or proanthocyanic tannins*. Besides the two classes of tannins, each monomer unit itself (e.g. flavan-3-ol monomers, gallic acid, ellagic acid) can also occur in tannin preparations.

Hydrolysable tannins form a heterogeneous class that is divided into two sub-classes:

- gallotannins or gallic tannins consist of a glucose or quinic acid unit that is esterified with one or more molecules gallic acid and/or its depsides.
- ellagitannins or ellagic tannins consist of glucose unit(s) that is/are esterified with one or more molecules of ellagic acid and related molecules. In addition, the glycosidic unit(s) may be esterified with gallic acid and/or its/their depsides.

The structure of hydrolysable tannins varies according to the degree of esterification and polymerization (1)

Condensed or proanthocyanic tannins (of the procyanidin and prodelphinidin sub-classes and the profisetinidin and prorobinetidin sub-classes) and consist of polymers of flavan-3-ols. The flavan-3-ol units may differ stereochemically as well as in the degree of hydroxylation and may be present as gallic acid esters. The large variety of monomeric units, different interflavan bonds and the degree of polymerization result

in a large number of possible structures of proanthocyanidins. Depending on the molecular structure, the reactivity of proanthocyanidins can vary greatly.

Oenological tannins come exclusively in powder, granule or flake form, from light beige or beige and brick red to dark brown in colour.

They can be dissolved in a portion of must or wine for incorporation into the total amount of must or wine.

2. LABELLING

The labelling of oenological tannins must specify the following:

- their botanical origin (e.g. oak, quebracho, etc.),
- the classes to which they belong (hydrolysable or condensed),
- the sub-classes (e.g. gallotannins, prodelphinidins, etc.),
- the batch number and the expiry date,
- the minimum content of total polyphenols according to the method in Annex 1,
- the technological functions,
- when tannin preparations are a mixture of several tannin classes or tannin sub-classes the different tannin classes or sub-classes and associated technological functions,
- the recommended dosage and conditions of use,
- the storage conditions to guarantee their stability,
- the possible presence of potentially allergenic residues,
- where applicable, the indication that the oenological tannins were obtained from genetically-modified plants.

3. PERMITTED OENOLOGICAL TANNINS

The oenological tannins that are described in Chapter 1, that have demonstrable and measurable properties as well as a technological interest duly proven in practice, and that completely fulfil the conditions and criteria mentioned below, are permitted in compliance with the files of the Code of Oenological Practices.

The oenological tannins used should not:

- liberate substances in concentrations that could lead to potential health risks,
- cause fraud resulting from the addition of aromas or coloring,
- be harmful to the quality of the products made,
- result in the modification of the well-known organoleptic profile of wine (flavouring).

4. REACTIVITY PROPERTIES AND FUNCTIONS OF OENOLOGICAL TANNINS

4.1 Reactivity

Tannins are likely to be involved in numerous reaction pathways in wine. The reactivity of oenological tannins is directly related to the specific characteristics of their chemical structures; it also depends on the technical operations of production (techniques of extraction, concentration, fractionation, etc.), which influence the polyphenol content (thus the degree of purity) and the proportion of free functional groups. The nature of the plant determines the tannin class(es) or sub-class(es) to which they belong.

4.2 Properties and functions of tannins

The functions of oenological tannins are directly linked to their properties. The methods of analysis used to determine the functions of tannins should correspond to the state of the art and, if possible, be validated according to the appropriate international standards.

The following table lists properties as well as oenological applications, some of which are recognised and some of which remain to be demonstrated.

Theoretical properties	Possible oenological applications
Reactivity with proteins	Clarification aid
Reactivity with oxygen	Antioxidant
Iron chelation	Reduction of iron content
Polymerisation	Colour stabilisation
Formation of complexes	Colour stabilisation

Anti-laccase activity	Inhibition of laccase-activity
Microbiological action	
Antibacterial effect	Microbiological stability, reduction in SO ₂ use

The properties and resulting oenological applications will be the object of specific monographs by classes of tannins and/or sub-classes, in which the methods of measurement shall be specified.

4.3 Estimation of the total polyphenol content

The estimation of the total polyphenol content of preparations of oenological tannins is measured by the method described in Annex 1.

The total polyphenol content should be greater than or equal to 65% and a maximum concentration is not required

5. PHYSICAL PROPERTIES

5.1 Insoluble materials

Place 5 g tannin in a solution of 100 mL double-distilled water at room temperature and stir for 15 minutes. After that filter this solution over a 0.8 µm membrane previously weighed. Evaporate and dry the membrane at 100-105 °C. Weight the membrane. The insoluble matter content should not be greater than 5% w/w.

The procedure described later in the total polyphenol content method (Annex 1, point 4.3) could be used as an alternative.

5.2 Loss on drying

Determined up to constant weight, for a 2 g sample, the weight loss in an oven at 100-105 °C for 2 hours should be less than 10%.

6. MAXIMUM CONTAMINANTS LEVELS

Oenological tannins should be produced in accordance with good manufacturing practices. According to the origin of the plant used, some maximum contaminant levels – such as those for heavy metals – may be different (e.g. the iron content of chestnut-derived tannins).

All of the limits set below relate to dry products.

6.1 Pentachlorophenol

Proceed with determination according to the method described in the OIV Compendium of the International methods of musts and wines. Content should be less than 1 µg/kg.

6.2 Total polycyclic aromatic hydrocarbons (PAH)

Sum of benzo(a)pyrene, benz(a)anthracene, benzo(b)fluoroanthene and chrysene

Proceed with determination according to the method described in Chapter II of the International Oenological Codex. Content should be less than 30 µg/kg.

6.3 Benzo(a)pyrene

Proceed with determination according to the method described in Chapter II of the International Oenological Codex. Content should be less than 5 µg/kg.

6.4 Ashes

Without going above 550 °C, progressively incinerate the residue left by the determination of the loss on drying. The weight of the ashes should be less than 5%. A Higher concentration could mean that the extraction was done with non-authorized solvents.

6.5 Preparation of the test solution

Dissolve the ashes obtained from 2 g tannin into 1 mL diluted hydrochloric acid (R) and a drop of concentrated nitric acid (R). Heat in a water bath at 100 °C for a short time to ensure dissolution is complete. Transfer to a 50-mL calibrated flask, rinsing the capsule with distilled water, and make up to the mark. The test solution is ready to dose following elements.

6.6 Arsenic

For 0.25 g tannin, detect arsenic using the atomic-absorption-spectrophotometry method described in Chapter II of the International Oenological Codex or using ICP/MS according to the method described in the Compendium of International Methods of Wine and Must Analysis, after destruction of the organic matter using the wet method. The arsenic content should be less than 3 mg/kg.

6.7 Iron

On the basis of 10 mL of test solution prepared according to paragraph 6.5, determine the iron using atomic-absorption-spectrometry according to the method in Chapter II of the International Oenological Codex or using the ICP/MS method described in the Compendium of International Methods of Wine and Must Analysis.

The iron content should be less than 50 mg/kg, with the exception of chestnut-derived tannins, whose iron content should be less than or equal to 200 mg/kg .

6.8 Copper

Proceed with determination according to the method described in Chapter II of the International Oenological Codex or by ICP/MS according to the method described in the Compendium of International Methods of Wine and Must Analysis. Content should be less than 5 mg/kg.

6.9 Lead

Proceed with determination according to the method described in Chapter II of the International Oenological Codex or by ICP/MS according to the method described in the Compendium of International Methods of Wine and Must Analysis. Content should be less than 5 mg/kg.

6.10 Mercury

Proceed with determination according to the method described in Chapter II of the International Oenological Codex or by ICP/MS according to the method described in the Compendium of International Methods of Wine and Must Analysis. Content should be less than 0.5 mg/kg.

6.11 Cadmium

Proceed with determination according to the method described in Chapter II of the International Oenological Codex or by ICP/MS according to the method described in the Compendium of International Methods of Wine and Must Analysis. Content should be less than 0.5 mg/kg.

6.12 Salmonella

Proceed with counting according to the method described in Chapter II of the International Oenological Codex. Absence should be checked on a 25 g sample of dry matter.

6.13 Total coliforms

Proceed with counting according to the method described in Chapter II of the International Oenological Codex. Content should be less than 30 CFU/g of dry matter.

6.14 Escherichia coli

Proceed with counting according to the method described in Chapter II of the International Oenological Codex. Absence should be checked on a 25 g sample of dry matter.

6.15 Moulds

Proceed with counting according to the method described in Chapter II of the International Oenological Codex. Content should be less than 100 CFU/g of dry matter.

(1) Encyclopaedia health food Pub off 00683

Annex 1 METHOD FOR THE ESTIMATION OF THE TOTAL POLYPHENOL CONTENT

1. PRINCIPLE

This method is designed to measure the concentration in polyphenols of preparations of oenological tannins and is based on gravimetric analysis using solid-phase extraction (SPE). In an SPE column, tannins in aqueous solution are adsorbed onto a polymer (in this case polyvinylpyrrolidone) capable of retaining polyphenols. The substances not retained by the PVPP correspond to non-phenolic compounds that were present in the original sample.

The full diagram of the method is presented below:

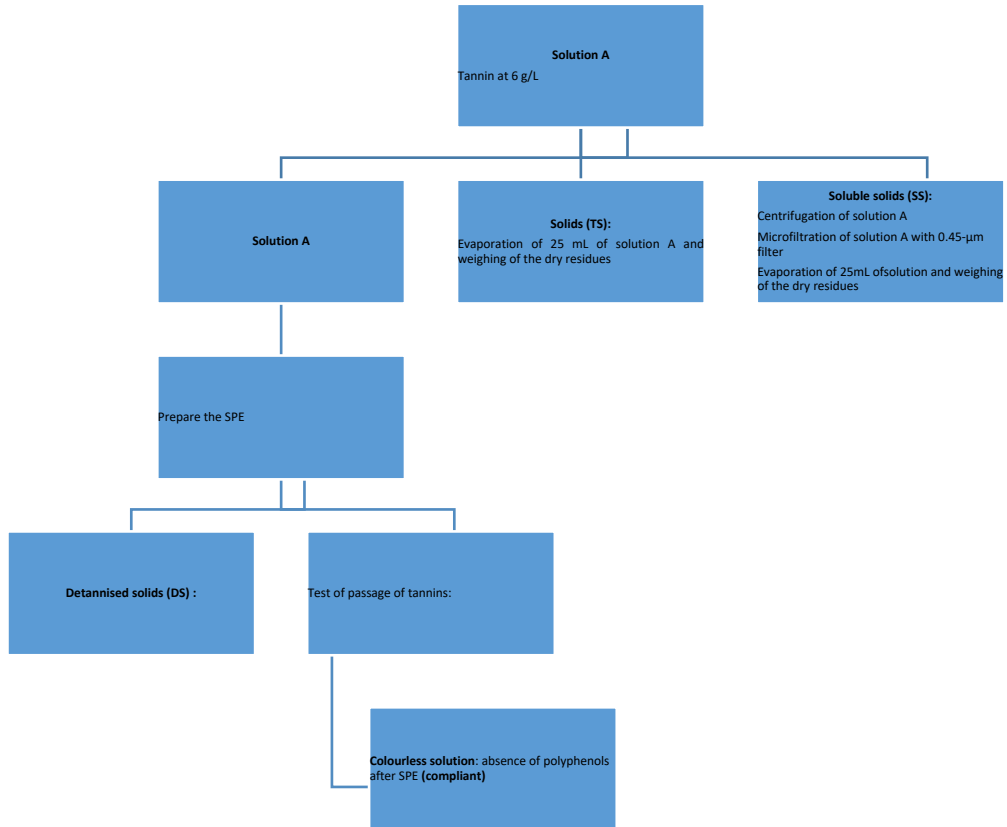

2. REAGENTS, MATERIALS AND APPARATUS

2.1 Reagents

- 2.1.1 PVPP (approx. 100 µm polyvinylpolypyrrolidone, CAS No. 9003-39-8)
- 2.1.2 Aqueous solution of FeCl₃ (1 g/L)
- 2.1.3 Double-distilled water
- 2.1.4 Ethanol (20 % v/v)

2.2 Materials

- 2.2.1 Aluminium dishes (70 mL)
- 2.2.2 Disposable tubes with a conical base and stoppers (50 mL)
- 2.2.3 SPE columns (70 mL reservoir, 150 x 29,75 mm)
- 2.2.4. Frits for SPE column (diameter 27 mm, 20 µm PE)
- 2.2.5 1 000-mL Pyrex flask
- 2.2.6 50-mL Class-A test tubes
- 2.2.7 0.45 µm Cellulose acetate membrane filter, Ø 47 mm
- 2.2.8 Plastic 50-mL syringe
- 2.2.9 25-mL Class-A graduated glass pipettes (2 marks)

2.3 Apparatus

- 2.3.1 Thermostatic bath at 20 °C
- 2.3.2 Technical balance with precision of 0.01 g
- 2.3.3 Analytical balance with precision of 0.1 mg
- 2.3.4 Thermostatic oven at 105 °C
- 2.3.5 Thermostatic oven at 80 °C or, failing this, a thermostatic bath
- 2.3.6 Centrifuge
- 2.3.7 Vacuum manifold
- 2.3.8 Class-A volumetric glassware

2.3.9 Desiccator

3. PREPARATION OF SAMPLES

The solution (referred to below as solution A) is used to measure the total solids (TS), soluble solids (SS) and detannised solids (DS).

Weigh approximately 6 g tannins on the analytical balance and make a note of the weight. Dissolve the tannins in around 950 mL hot double-distilled water (60-70 °C) in a 1-L borosilicate-glass flask and mix well. Leave the flask to rest at room temperature for 30 minutes. Cool the solution at 20-22 °C in a thermostatic bath, make up to volume with double-distilled water and mix well.

4. PROCEDURE

4.1 Measurement of total solids (TS)

- Take a sample and transfer 25 mL of solution A to an aluminium dish (2.2.1),
- evaporate to dryness in a thermostatic oven at 80 °C,
- transfer to a thermostatic oven at 105 °C in order to proceed with drying until a constant weight is obtained, then weigh the residue (cool the dish in the desiccator before weighing).

The formula to be applied for the calculation of the total solids (TS) is as follows:

$$\%TS = \frac{TS_dry_residues (g)}{tannins_weight (g)} \cdot \frac{1\ 000}{solA (mL)} \cdot 100$$

4.2 Measurement of soluble solids (SS)

- Centrifuge solution A at 10 000 g during 5 minutes,
- microfilter solution A centrifuged through a membrane filter in order to obtain a clear solution, then leave 25 mL of solution to evaporate to dryness in a thermostatic oven at 80 °C,
- transfer to a thermostatic oven at 105 °C in order to proceed with drying until a constant weight is obtained, then weigh the residue (cool the dish in the desiccator before weighing).

The formula to be applied for the calculation of soluble solids (SS) is as follows:

$$\%SS = \frac{SS_dry_residues (g)}{tannins_weight (g)} \cdot \frac{1\ 000}{solA (mL)} \cdot 100$$

4.3 Measurement of insoluble solids (IS)

Calculate the difference between the total solids and soluble solids:

$$\%IS = \%TS - \%SS$$

4.4 Measurement of detannised solids (DS)

- Prepare the SPE columns: introduce the first frit, 7.0 g ± 0.1 g PVPP rehydrated beforehand with a hydro-alcoholic solution at 20% for 15 minutes, as well as the second frit, then pack the stationary phase in well,
- place the SPE column in a vacuum manifold (example in Figure 1),
- pack the column with three rinses (do not dry out the PVPP and apply a vacuum of approx. 0.2 bar in order to avoid compacting of the polymer): a first rinse with 50 mL ethanol (20 % v/v), a second rinse with 50 mL double-distilled water, and a third rinse with 20 mL solution A in order to eliminate the water residues of the PVPP,
- add 30 mL of solution A to the column and collect 30 mL eluate (DS, detannised solids) in a 50-mL Falcon tube with a conical base, interrupting the elution when the liquid reaches the level of the upper frit,
- take a sample of 25 mL eluate and transfer this into an aluminium dish,
- leave to evaporate to dryness in a thermostatic oven at 80 °C,
- transfer to a thermostatic oven at 105 °C in order to proceed with drying until a constant weight is obtained, then weigh the residue (cool the dish in the desiccator before weighing).

The formula to be applied for the calculation of detannised solids (DS) is as follows:

$$\%DS = \frac{DS_dry_residues (g) - BC (g)}{tannins_weight (g)} \cdot \frac{1\ 000}{solA (mL)} \cdot 100$$

where BC is the value of the blank measured after SPE (see 4.5).



Figure 1 - Example SPE extraction

In order to guarantee the absence of polyphenols in the eluate after passing through the column, add 3 drops of an aqueous solution of $FeCl_3$ to 3 mL detannised solids (DS) in solution. If the solution develops a blue-black hue, this means that the polyphenols have passed through the polymer; the analysis should then be repeated by reducing the quantity of initial product. If the solution remains colourless after this treatment, proceed with gravimetric analysis.

4.5 Measurement of the blank (BC)

A blank test should be carried out before conducting the SPE elution, in order to evaluate any interference caused by the analytical process. Proceed as follows:

- prepare the SPE columns: introduce the first frit, 7.0 g \pm 0.1 g PVPP rehydrated beforehand with a hydro-alcoholic solution at 20% for 15 minutes, as well as the second frit, then pack in well,
- place the SPE column in a vacuum manifold (example in Figure 1),
- pack the column with two rinses (do not dry out the PVPP and apply a vacuum of approx. 0.2 bar in order to avoid compacting

of the polymer): a first rinse with 50 mL ethanol (20 % v/v) and a second rinse with 70 mL double-distilled water,

- add 30 mL double-distilled water to the column and collect 30 mL eluate (blank for detannised solids) in a 50-mL Falcon tube with a conical base, interrupting the elution when the liquid reaches the level of the upper frit,
- take a sample of 25 mL eluate and transfer this into an aluminium dish, then leave to evaporate to dryness in a thermostatic oven at 80 °C,
- transfer to a thermostatic oven at 105 °C in order to proceed with drying until a constant weight is obtained, then weigh the residues (cool the dishes in the desiccator before weighing).

5. EXPRESSION OF RESULTS

Measurement of the percentage of total polyphenols (%polyphenols):

The formula to be applied for the calculation of the percentage is as follows:

$$\%polyphenols = \frac{\%SS - \%DS}{\%TS} \cdot 100$$

- Determination of the suitability of the PVPP: refer to OENO 11-2002 - COEI-1-PVPP: 2007, § 6.

OENOLOGICAL TANNINS**Specific monograph for oenological tannins containing
procyanidins/prodelphinidins**

(OIV-OENO 675A-2022)

Procyanidins/prodelphinidins are a sub-class of condensed (or proanthocyanic) tannins. Tannins from *Vitis vinifera* grapes, grape skins and grape seeds are included in this sub-class.

1. Method for the determination of sub-class affiliations**Characterisation by high-performance liquid chromatography
(HPLC)****1.1.Principle**

This method is designed to verify the presence of characteristic components of condensed tannins of the procyanidin/prodelphinidin sub-class and measure their total concentration. It is applicable to preparations of oenological tannins that are declared as pure and thus as not containing tannins with small masses from different families or sub-classes.

1.1.2. Reagents, material and apparatus**1.1.2.1. Reagents**

(+)-catechin, CAS No.: 154-23-4
Ultrafiltered water (resistivity: 18.3 M Ω ·cm)
Water (HPLC quality)
Methanol (HPLC quality)
Formic acid (HPLC quality)

1.1.2.2. Materials

100-mL borosilicate-glass flask
Cellulose filters with 0.45 μ m pore size diameter
Plastic 1-mL syringe

1.1.2.3. Apparatus

Analytical balance with precision of 0.01 g
Analytical balance with precision of 0.1 mg
Class-A volumetric glassware

Mass chromatographic system with spectrometry detection composed of:

- Gradient pump for binary or quaternary mix
- Injector with a loop of 10 µL
- Spectrophotometric detector at 280 nm fixe wavelength
- Column Eclipse Plus C-18 (for example): 2.1 x 100 mm, 1.8 µm particle size
- ESI-SIM (Selected Ion Monitoring mode via Electro Spray Ionisation) ionisation source
 - Mass spectrometer detector: quadrupole time of flight (Q-TOF)

1.1.3. Preparation of samples and standards

Samples: weigh approximately 0.5 g of oenological tannins on the analytical balance and make a note of the weight. Dissolve the oenological tannins in 100 mL of ultrafiltered water in a 100-mL borosilicate-glass flask and mix well.

Preparation of standard solutions: put 10 mg of (+)-catechin in solution into 50 mL of ultrafiltered water, corresponding to a 200 mg/L concentration. Then carry out dilutions in ultrafiltered water to obtain 5, 10, 20, 40, 60, 80 and 100 mg/L concentrations.

Solvent A: HPLC-quality water containing 0.1% of formic acid.

Solvent B: methanol containing 0.1% of formic acid.

1.1.4. Procedure

The sample solution and standard solutions are filtered on 0.45 µm (pore size diameter) filters and analyse by chromatography under the following conditions:

Injected volume: 10 µL of sample solution or standard solution of (+)-catechin

Detection at 280 nm

Composition of elution gradient: (time, % of solvent A)

0 min, 99.0%; 0.5 min, 94.0%; 20 min, 50.0%; 25 min, 0.0%; 32 min, 94.0% and 10 min for equilibrium.

Flow rate: 0.3 mL/min

Quantification and detection of the characteristic components of condensed tannins of the procyanidin/prodelphinidin sub-group (sub-class) ((+)-catechin, (-)-epicatechin, (+)gallocatechin,

epigallocatechin, (-)-epicatechin-3-O-gallate, (-)-epigallocatechin-3-O-gallate, dimers B1, B2, B3 and B4, B2-3-O-gallate, trimers) according to the ESI-SIM scan and Q-ToF detection, for example.

Table 1: Example chemical formulas and masses of the different procyanidins/prodelphinidins

Compound	Chemical formulas	m/z
(+)-catechin	C ₁₅ H ₁₄ O ₆	290.1
(-)-epicatechin	C ₁₅ H ₁₄ O ₆	290.1
(-)-epicatechin-3-O-gallate	C ₂₂ H ₁₈ O ₁₀	442.1
Dimer B1	C ₅₀ H ₂₆ O ₁₂	578.1
Dimer B2	C ₅₀ H ₂₆ O ₁₂	578.1
Dimer B3	C ₅₀ H ₂₆ O ₁₂	578.1
Dimer B4	C ₅₀ H ₂₆ O ₁₂	578.1
B2-3-O-gallate	C ₃₇ H ₃₀ O ₁₆	730.1
Trimers	C ₄₅ H ₃₈ O ₁₈	866.2

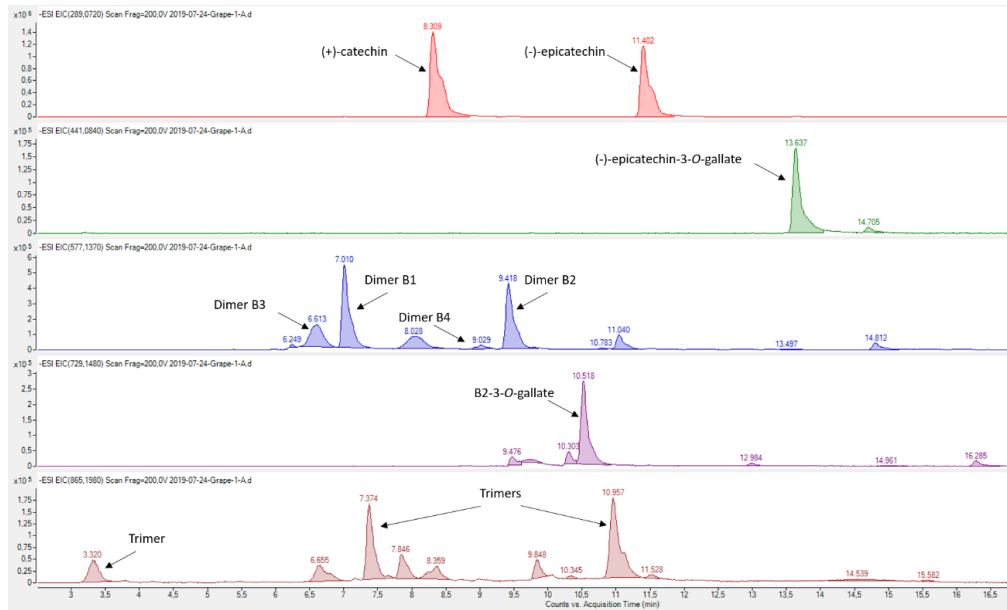

Figure 1: Example of ESI-SIM scan of procyanidins/prodelphinidins

1.2. Conclusion

An oenological tannin is recognised as a procyanidin/prodelphinidin when:

- its total polyphenol content is higher than 65% (gravimetric method in Annex 1 of the general monograph OIV-OENO 624-2022),
- its procyanidin/prodelphinidin content as characterised by the HPLC method is higher than 120 mg equivalent of (+)-catechin per gram of oenological tannins.

2. Methods of measurement of properties and functionalities

The following compliance methods and criteria are only applicable when the property/functionality is claimed on the preparation of tannins.

2.1. Antioxidant ability

2.1.1. Principle

Determination of procyanidins/prodelphinidins' ability to contribute to the protection of must and wine from oxidation.

2.1.2. Products**2.1.2.1. Antioxidant capacity**

DPPH (2,2-diphenyl-1-picrylhydrazyl): MM = 394.32

Trolox (6-hydroxy-2,5,7,8-tetramethylchroman-2-carboxylic acid): MM = 250.29

Methanol at 99.9% volume

96-well microplate reader (FLUOstar Omega - BMG Labtech, for example)

2.1.2.2. Direct oxygen consumption (OCR)

Ethanol at 96% volume, CAS No. 64-17-5

Tartaric acid: MM = 150.09, CAS No. 87-69-4

Iron (III) chloride hexahydrate: MM = 270.30, CAS No. 7705-08-0

Copper (II) sulfate pentahydrate: MM = 249.68, CAS No. 7758-98-7

Clear glass bottles with inserted pills of 0.75-cL capacity
NomaSens oximeter, for example

2.1.3. Protocols**2.1.3.1. Antioxidant capacity (DPPH assay)**

0.15 g/L oenological tannin solution: dissolve 37.5 mg of oenological tannins in 500 mL of model wine solution (distilled water, 12% vol. of ethanol, 4 g/L of tartaric acid and pH adjusted to 3.5). Dilution of oenological tannins solution could be needed if the measurement absorbance is higher than 1 unit (in this case the dilution should be included in the calculation).

1mM Trolox solution: dissolve 125 mg of Trolox in 500 mL of model wine solution (distilled water, 12% vol. of ethanol, 4 g/L of tartaric acid and pH adjusted to 3.5).

Calibration curve: dissolve in 1, 0.8, 0.6, 0.4, 0.2 and 0.1 mL of 1mM Trolox solution into 0, 0.2, 0.4, 0.6, 0.8 and 0.9 mL of model wine solution. These quantities correspond to 1, 0.8,

0.6, 0.4, 0.2 and 0.1 mM final concentration of Trolox respectively.

6.10⁻⁵ M DPPH solution: dissolve 2.36 mg of DPPH in 100 mL of methanol. The solution should be freshly prepared.

2.1.3.2. Direct oxygen consumption (OCR)

1 g/L oenological tannin solution: dissolve 0.75 g of oenological tannins in 750 mL of model wine solution.

Model wine solution: dissolve 4 g of tartaric acid, 2.25 mg of Iron (III) chloride hexahydrate and 0.225 mg of Copper (II) sulfate pentahydrate in 90 mL of ethanol and 660 mL of distilled water. The pH should be adjusted at 3.5.

2.1.4. Tests

2.1.4.1. Antioxidant capacity

First a blank containing solely the DPPH reagent (RB) is measured at 515 nm by placing 190 µL of DPPH solution (1.3.1) in all the wells of the plate. Then, add 10 µL of oenological tannin solution (samples), distilled water (blank) or Trolox curve solution (standards) into the wells and measure (MS) at 515 nm after 30 min.

See Figure 2 for an example of how to fill the plate.

The formula to be applied for the calculation of the antioxidant capacity is as follows:

$$1) \quad RB - MS = x$$

$$2) \quad \frac{250.29 \text{ (mg)}}{0.15 \text{ (g)}} \times \frac{x-b}{a} = \text{antioxidant capacity (mg eq. Trolox per g of tannins)}$$

where "a" and "b" correspond respectively to the slope and the constant of the Trolox calibration curve:
Absorbance = f ([Trolox]) → Absorbance = ax + b

In all cases, procyanidins/prodelphinidins should demonstrate antioxidant capacity, and more specifically they should have more than 500 ± 50 mg

equivalent Trolox per gram of tannins (commercial extract).

	1	2	3	4	5	6	7	8	9	10	11	12
A	T 0.1	T 0.1	T 0.2	T 0.2	T 0.4	T 0.4	T 0.6	T 0.6	T 0.8	T 0.8	T 1	T 1
B	T 0.1	T 0.1	T 0.2	T 0.2	T 0.4	T 0.4	T 0.6	T 0.6	T 0.8	T 0.8	T 1	T 1
C	Blank	OT 1	OT 2	OT 3	OT 4	OT 5	OT 6	OT 7	OT 8	OT 9	OT 10	OT 11
D	Blank	OT 1	OT 2	OT 3	OT 4	OT 5	OT 6	OT 7	OT 8	OT 9	OT 10	OT 11
E	Blank	OT 1	OT 2	OT 3	OT 4	OT 5	OT 6	OT 7	OT 8	OT 9	OT 10	OT 11
F	Blank	OT 1	OT 2	OT 3	OT 4	OT 5	OT 6	OT 7	OT 8	OT 9	OT 10	OT 11
G	Blank	OT 1	OT 2	OT 3	OT 4	OT 5	OT 6	OT 7	OT 8	OT 9	OT 10	OT 11
H	Blank	OT 1	OT 2	OT 3	OT 4	OT 5	OT 6	OT 7	OT 8	OT 9	OT 10	OT 11

T = Trolox

OT = Oenological Tannins

Figure 2: example 96-well plate

2.1.4.2. Direct oxygen consumption (OCR)

First the model wine solution is saturated with oxygen at 8 mg/L by bubbling with air for 10 min at 20-25 °C. Then, add the oenological tannins to the model wine solution in the bottles filled to 0.75 cL. Seal the bottles hermetically and shake to fully homogenise.

1. Measure the oxygen consumed every two days starting 1h after the filled of the bottles.
2. To determine the oxygen consumption rate, follow the pathway as shown in **Figure 2**:
 - represent the oxygen consumption versus the time,
 - then represent the inverse of the oxygen consumed versus the inverse of the time,
 - the oxygen consumption rate corresponds to the inverse of the slope coefficient:
 - $OCR = \frac{1}{A}$ mg of O₂ consumed per day and per g of tannins = 1/A, A being the slope coefficient

In all cases, procyanidins/prodelphinidins should demonstrate an ability to consume the oxygen directly, and more specifically they should be able to consume

at least 0.10 ± 0.05 mg of O₂ per litre, per day and per gram of tannins (commercial extract).

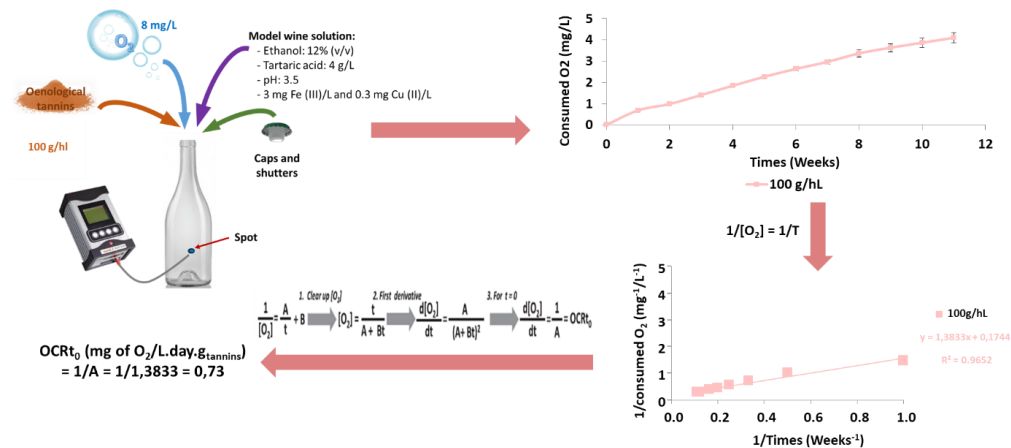

Figure 3: Pathway to determine oxygen consumption rate

2.1.4.3. Antioxidasic ability

2.1.4.3.1. Principle

Determination of procyanidins/prodelphinidins' antioxidasic ability to contribute to antioxidasic protection in terms of the laccase activity of compounds in must and wine.

2.1.4.3.2. Products

Ethanol at 96% volume, CAS No. 64-17-5
 Tartaric acid: MM = 150.09, CAS No. 87-69-4
 Sodium acetate: MM = 82.03, CAS No. 6131-90-4
 Syringaldazine (4-hydroxy-3,5-dimethoxybenzaldehyde azine):
 MM = 360.36, CAS No. 14414-32-5
 Polyvinylpolypyrrolidone (PVPP): CAS No. 25249-54-1
 Must botrytised with laccase activity
 Distilled water (HPLC quality)

2.1.4.3.3. Protocols

2 g/L oenological tannin solution: dissolve 200 mg of oenological tannins in 100 mL of model wine solution (distilled water, 12% vol. of ethanol, 4 g/L of tartaric acid and pH adjusted to 3.5).

Buffer solution (8.2 g/L): dissolve 410 mg of sodium acetate in 50 mL of distilled water.

Syringaldazine solution (0.06 g/L): dissolve 30 mg of syringaldazine in 500 mL of ethanol.

2.1.4.4. Tests

- 1) Add 4 mL of botrytised must to 1 mL of oenological tannin solution in one tube, which will correspond to sample modality.
- 2) Add 4 mL of botrytised must to 1 mL of model wine solution in one tube, which will correspond to control modality.
- 3) After 4 minutes (precisely), add 0.8 g of PVPP to both tubes (sample and control modalities), stir and centrifuge for 10 minutes at 8,500 rpm.
- 4) Recover 1 mL of the supernatant (for both sample and control modalities), into 1.4 mL of buffer solution and 0.6 mL of syringaldazine solution. Put the mixture into a plastic spectrophotometer cuvette (10 mm path length).
- 5) Measure the absorbance at 530 nm every minute for 5 minutes (including time measurements at 0 minutes).
- 6) Then determine the laccase activity and the residual laccase activity by using the following equations and **Figure 3**:
- 7)

$$\text{Laccase activity} = 46.15 \times \Delta A \mu\text{mol. L}^{-1} \cdot \text{min}^{-1} = 46.15 \times \Delta A \text{ UL}$$

$$\% \text{ of residual activity} = (\text{laccase activity}_{\text{sample}} / \text{laccase activity}_{\text{control}}) \times 100$$

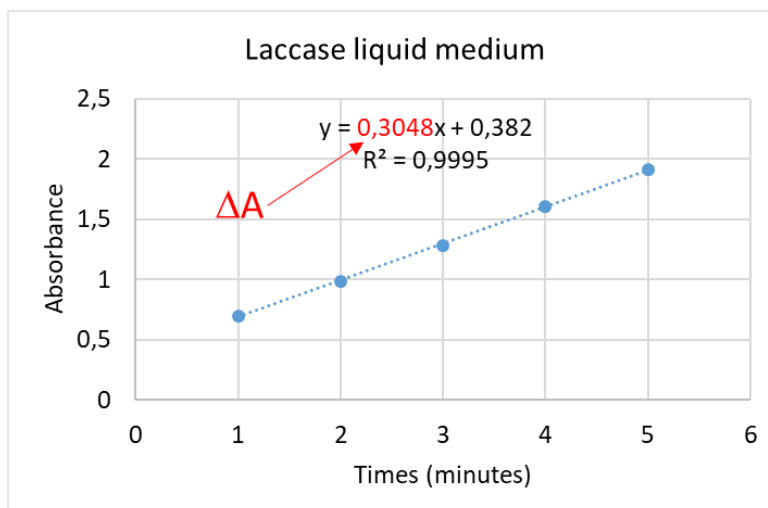

Figure 4: Example determination of ΔA .

In all cases, procyanidins/prodelphinidins should demonstrate an antioxidasic ability, and more specifically they should be able to reduce the residual laccase activity by at least 50%. This value is valuable for must and wine containing less than 5 UL (units of laccases).

2.1.5. Colour stabilisation

2.1.5.1. Principle

Determination of procyanidin/prodelphinidin colour stabilisation properties to promote the expression, stabilisation and preservation of colour in red must and wine.

2.1.5.2. Products

Ethanol at 96% volume, CAS No. 64-17-5

Tartaric acid: MM = 150.09, CAS No. 87-69-4

Malvidin-3-*O*-glucoside: MM = 528.87, CAS No. 18470-06-9

2.1.5.3. Protocols

0.8 g/L oenological tannin solution: dissolve 80 mg of oenological tannins in 100 mL of model wine solution (distilled water, 12% vol. of ethanol, 4 g/L of tartaric acid and pH adjusted to 3.5).

0.1 g/L malvidin-3-*O*-glucoside solution: dissolve 10 mg of malvidin-3-*O*-glucoside in 100 mL of model wine solution

(distilled water, 12% vol. of ethanol, 4 g/L of tartaric acid and pH adjusted to 3.5).

2.1.5.4. Tests

- 1) Place 0.75 mL of oenological tannin solution and 0.75 mL of model wine solution in one 2-mL stoppered conical tube – hereinafter a “tube” – and keep it in the dark at room temperature. This tube will be called “T₀”.
- 2) Place 0.75 mL of malvidin-3-*O*-glucoside solution and 0.75 mL of model wine solution in one tube and keep it in the dark at room temperature. This tube will be called “M”.
- 3) Place 0.75 mL of oenological tannin solution and 0.75 mL of malvidin solution in one tube and keep it in the dark at room temperature. This tube will be called “T_M”.
- 4) After 7 days, measure the absorbance at 450, 520, 570 and 630 nm of the three tubes (T_M, T₀ and M).
- 5) Subtract the absorbance values of T₀ to T_M to obtain the absorbance, taking into account the absorbances of the oenological tannins used.
 $A(T_M) - A(T_0) = A(T)$
- 6) Then, determine the CIELAB coordinates (L*, a* and b*) corresponding to the tannin solution with malvidin-3-*O*-glucoside (T) and malvidin-3-*O*-glucoside solution (M) with the free MSCV software (<https://www.unirioja.es/color/descargas.shtml>) or equivalent.

The formulas to be applied for the calculation of the copigmentation index are as follows:

$$1) \Delta E_{ab,TS} = \sqrt{(L^*_T - L^*_W)^2 + (a^*_T - a^*_W)^2 + (b^*_T - b^*_W)^2}$$

$$2) \Delta E_{ab,CS} = \sqrt{(L^*_M - L^*_W)^2 + (a^*_M - a^*_W)^2 + (b^*_M - b^*_W)^2}$$

$$3) \text{ Copigmentation Index (\%)} = 100 \times \frac{\Delta E_{ab,TS} - \Delta E_{ab,CS}}{\Delta E_{ab,CS}}$$

$\Delta E_{ab,TS}$: total colour difference between the solution of malvidin-3-*O*-glucoside containing commercial tannins (T) and a pure white colour solution (W).

$\Delta E_{ab,CS}$: total colour difference between the solution of malvidin-3-O-glucoside (M) and a pure white colour solution (W).

The CIELAB coordinates of a pure white colour solution are $L^* = 100.00$, $a^* = 0.00$ and $b^* = 0.00$.

In all cases, procyanidins/prodelphinidins should demonstrate an ability to stabilise the colour, and more specifically their copigmentation index should read as higher than $7.0 \pm 2.0\%$ after 7 days.

Note: Alternative methods of determination can be used in place of any of the methods described, on the condition that these have been internally validated.

3. Bibliography

- Sarneckis, C.J.; Dambergs, R.G.; Jones, P.; Mercurio, M.; Herderich, M.J.; Smith, P.A. Quantification of condensed tannins by precipitation with methyl cellulose: development and validation of an optimised tool for grape and wine analysis. *Australian Journal of Grape Wine Research* **2006**, *12*, 39–49.
- Vignault, A.; González-Centeno, M.R.; Pascual, O.; Gombau, J.; Jourdes, M.; Moine, V.; Iturmendi, N.; Canals, J.M.; Zamora, F.; Teissedre, P.-L. Chemical characterization, antioxidant properties and oxygen consumption rate of 36 commercial oenological tannins in a model wine solution. *Food Chemistry* **2018**, *268*, 210–219.
- Vignault, A.; Pascual, O.; Jourdes, M.; Moine, V.; Fermaud, M.; Roudet, J.; Canals, J.M.; Teissedre, P.-L.; Zamora, F. Impact of oenological tannins on laccase activity. *OENO One* **2019**, *53*, 27–38.
- Vignault, A.; Pascual, O.; Gombau, J.; Jourdes, M.; Moine, V.; Canals, J.M.; Teissedre, P.-L.; Zamora, F. Recent advances of the OIV working group on oenological tannins in the study of the functionalities of oenological. *BIO Web of Conferences* **2019**, *15*, 02015.
- Vignault, A.; Gombau, J.; Pascual, O.; Jourdes, M.; Moine, V.; Canals, J.M.; Zamora, F.; Teissedre, P.-L. Copigmentation of Malvidin-3-O-Monoglucoside by Oenological Tannins: Incidence on Wine Model Color in Function of Botanical Origin, pH and Ethanol Content. *Molecules* **2019**, *24*, 1–15.
- Vignault, A.; Gombau, J.; Jourdes, M.; Moine, V.; Canals, J.M.; Fermaud, M.; Roudet, J.; Zamora, F.; Teissedre, P.-L. Oenological tannins to prevent Botrytis cinerea damage in grapes and musts:

kinetics and electrophoresis characterization of laccase. *Food Chemistry* **2020**, *316*, 126334.

- Vignault, A. Tanins œnologiques : caractéristiques, propriétés et fonctionnalités. Impact sur la qualité des vins. Thèse de doctorat, Université de Bordeaux et Universitat Rovira i Virgili, **2019**.

OENOLOGICAL TANNINS**Specific monograph for oenological tannins containing ellagitannins**

(OIV-OENO 675B-2022)

Ellagitannins are a sub-class of hydrolysable tannins. Chestnut and oak tree tannins are included in this sub-class.

1. Method for the determination of sub-class affiliations**1.1. Characterisation by high-performance liquid chromatography (HPLC)****1.1.1. Principle**

This method is designed to verify the presence of ellagitannins in oenological tannins and measure their total concentration.

1.1.2. Reagents, materials and apparatus**1.1.2.1. Reagents**

Vescalagin (purity > 96%), CAS No. 36001-47-5

Ultrafiltered water (resistivity: 18.3 MΩ·cm)

Water (HPLC quality)

Methanol (HPLC quality)

Formic acid (HPLC quality)

1.1.2.2. Materials

100-mL borosilicate-glass flask

Cellulose filters with 0.45 µm pore size diameter

Plastic 1-mL syringe

1.1.2.3. Apparatus

Technical balance with precision of 0.01 g

Analytical balance with precision of 0.1 mg

Class-A volumetric glassware

Mass chromatographic system with spectrometry detection composed of:

- Gradient pump for binary or quaternary mix

- Injector with a loop of 10 µL
- Spectrophotometric detector at 280 nm fixe wavelength
- Column Phenomenex Kinetex (for example): 150 x 3.0 mm, 2.6 µm particle size
- ESI-SIM (Single Ion Monitoring mode via Electro Spray Ionisation) ionisation source
- Mass spectrometer detector: triple quadrupole time of flight (Q-Tof)

1.1.3. Preparation of samples and standards

Samples: weigh approximately 0.5 g of oenological tannin on the analytical balance and make a note of the weight. Dissolve the oenological tannin in 100 mL of ultrafiltered water in a 100-mL borosilicate-glass flask and mix well.

Preparation of standard solutions: put 10 mg of vescalagin in solution into 50 mL of ultrafiltered water, corresponding to a 200 mg/L concentration. Then carry out dilutions in ultrafiltered water to obtain 0.1, 0.2, 0.5, 1, 2, 5, 10, 20, 40, 50 and 100 mg/L concentrations for the calibration curve.

Solvent A: water (HPLC quality) containing 0.1% of formic acid (HPLC quality).

Solvent B: methanol containing 0.1% of formic acid (HPLC quality).

1.1.4. Procedure

Oenological tannin solution and standard solutions are filtered on 0.45 µm (pore size diameter) filters and analyse by chromatography under the following conditions given by way of example:

Injected volume: 10 µL of oenological tannin solution or standard solution of vescalagin

Detection at 280 nm

Composition of elution gradient: (time, % of solvent A)

0min, 99.0%; 2 min, 98.0%; 5 min, 97.0%; 6 min, 96.5%; 7 min, 96.0%; 8 min, 95.5%; 10 min, 95.0%; 14 min, 90.0%; 17 min, 85.0%; 23 min, 80%; 35 min, 1.0% and 10 min for equilibrium.

Flow rate: 0.4 mL/min

Quantification and detection of the eight principal ellagitannins (vescalagin, castalagin, roburin A, B, C, D, E and grandinin) according to DAD (UV 280 nm) or the ESI-SIM scan with Q-ToF detection, which allows for more precise detection and quantification.

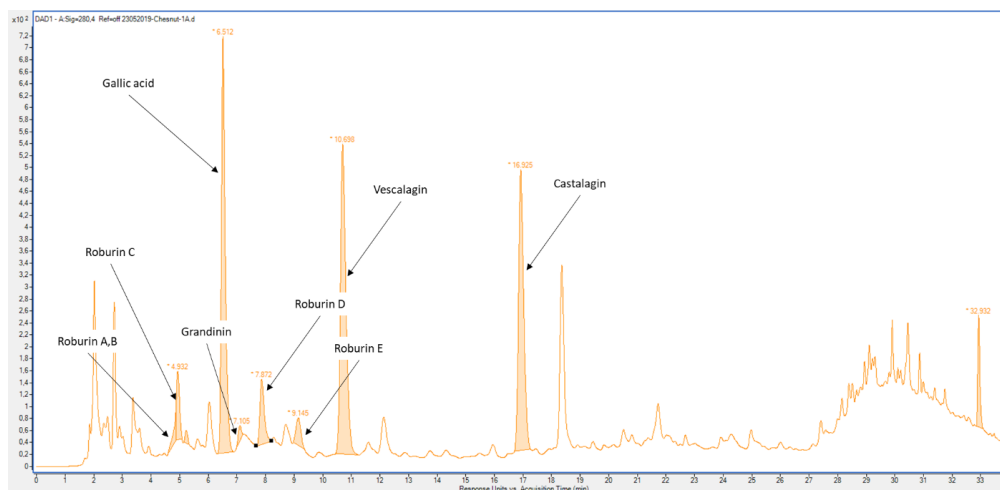

Figure 1: Example ellagitannin chromatogram at 280 nm

1.2. Conclusion

An oenological tannin is recognised as an ellagitannin (or ellagic tannin) when:

- its total polyphenol content is higher than 65% (gravimetric method in Annex 1 of the general monograph OIV-OENO 624-2022),
- its ellagitannin content is higher than 200 mg equivalent gallic acid per gram of oenological tannins (characterised by the HPLC method).

2. Methods of measurement of properties and functionalities

The following compliance methods and criteria are only applicable when the property/functionality is claimed on the preparation of tannins.

2.1. Antioxidant ability**2.1.1. Principle**

Determination of ellagitannins' antioxidant ability to contribute to the protection of must and wine from oxidation.

2.1.2. Products**2.1.2.1. Antioxidant capacity**

DPPH (2,2-diphenyl-1-picrylhydrazyl): MM = 394.32

Trolox (6-hydroxy-2,5,7,8-tetramethylchroman-2-carboxylic acid):
MM = 250.29

Methanol at 99.9% volume

96-well microplate reader (FLUOstar Omega - BMG Labtech, for example)

2.1.2.2. Direct oxygen consumption (OCR)

Ethanol at 96% volume, CAS No. 64-17-5

Tartaric acid: MM = 150.09, CAS No. 87-69-4

Iron (III) chloride hexahydrate: MM = 270.30, CAS No. 7705-08-0

Copper (II) sulfate pentahydrate: MM = 249.68, CAS No. 7758-98-7

Clear glass bottles with inserted pills of 0.75-L capacity

NomaSens oximeter (for example)

2.1.3. Protocols**2.1.3.1. Antioxidant capacity (DPPH assay)**

0.15 g/L oenological tannin solution: dissolve 37.5 mg of oenological tannins in 500 mL of model wine solution (distilled water, 12% vol. of ethanol, 4 g/L of tartaric acid and pH adjusted to 3.5). Dilution of oenological tannins solution could be needed if the measurement absorbance is higher than 1 unit (in this case the dilution should be included in the calculation).

1mM Trolox solution: dissolve 125 mg of Trolox in 500 mL of model wine solution (distilled water, 12% vol. of ethanol, 4 g/L of tartaric acid and pH adjusted to 3.5).

Calibration curve: dissolve in 1, 0.8, 0.6, 0.4, 0.2 and 0.1 mL of 1mM Trolox solution into 0, 0.2, 0.4, 0.6, 0.8 and 0.9 mL of model wine solution. These quantities correspond to 1, 0.8, 0.6, 0.4, 0.2 and 0.1 mM final concentration of Trolox respectively.

6.10^{-5} M DPPH solution: dissolve 2.36 mg of DPPH in 100 mL of methanol. The solution should be freshly prepared.

2.1.3.2. Direct oxygen consumption (OCR)

1 g/L oenological tannin solution: dissolve 0.75 g of oenological tannins in 750 mL of model wine solution.

Model wine solution: dissolve 4 g of tartaric acid, 2.25 mg of Iron (III) chloride hexahydrate and 0.225 mg of Copper (II) sulfate pentahydrate in 90 mL of ethanol and 660 mL of distilled water. The pH should be adjusted at 3.5.

2.1.4. Tests

2.1.4.1. Antioxidant capacity

First a blank containing solely the DPPH reagent (RB) is measured at 515 nm by placing 190 μ L of DPPH solution (1.3.1) in all the wells of the plate. Then, add 10 μ L of oenological tannin solution (samples), distilled water (blank) or Trolox curve solution (standards) into the wells and measure (MS) at 515 nm after 30 min.

See Figure 2 for an example of how to fill the plate.

The formula to be applied for the calculation of the antioxidant capacity is as follows:

$$1) \quad RB - MS = x$$

$$2) \quad \frac{250.29 \text{ (mg)}}{0.15 \text{ (g)}} \times \frac{x-b}{a} = \text{antioxidant capacity (mg eq. Trolox per g of tannins)}$$

where "a" and "b" correspond respectively to the slope and the constant of the Trolox calibration curve: Absorbance = f ([Trolox])
 \rightarrow Absorbance = ax + b

In all cases, ellagitannins (or ellagic tannins) should demonstrate an antioxidant capacity, and more specifically they should have more than 600 ± 50 mg equivalent Trolox per gram of tannins (commercial extract).

	1	2	3	4	5	6	7	8	9	10	11	12
A	T 0.1	T 0.1	T 0.2	T 0.2	T 0.4	T 0.4	T 0.6	T 0.6	T 0.8	T 0.8	T 1	T 1
B	T 0.1	T 0.1	T 0.2	T 0.2	T 0.4	T 0.4	T 0.6	T 0.6	T 0.8	T 0.8	T 1	T 1
C	Blank	OT 1	OT 2	OT 3	OT 4	OT 5	OT 6	OT 7	OT 8	OT 9	OT 10	OT 11
D	Blank	OT 1	OT 2	OT 3	OT 4	OT 5	OT 6	OT 7	OT 8	OT 9	OT 10	OT 11
E	Blank	OT 1	OT 2	OT 3	OT 4	OT 5	OT 6	OT 7	OT 8	OT 9	OT 10	OT 11
F	Blank	OT 1	OT 2	OT 3	OT 4	OT 5	OT 6	OT 7	OT 8	OT 9	OT 10	OT 11
G	Blank	OT 1	OT 2	OT 3	OT 4	OT 5	OT 6	OT 7	OT 8	OT 9	OT 10	OT 11
H	Blank	OT 1	OT 2	OT 3	OT 4	OT 5	OT 6	OT 7	OT 8	OT 9	OT 10	OT 11

T = Trolox

OT = Oenological Tannins

Figure 2: example 96-well plate

2.1.4.2. Direct oxygen consumption (OCR)

First the model wine solution is saturated with oxygen at 8 mg/L by bubbling with air for 10 min at 20-25 °C. Then, add the oenological tannins to the model wine solution in the bottles filled to 0.75 cL. Sealed the bottles hermetically and shake to fully homogenise.

1. Measure the oxygen consumed every two days starting 1h after the filled of the bottles.
2. To determine the oxygen consumption rate, follow the pathway as shown in **Figure 2**:

- represent the oxygen consumption versus the time,
- then represent the inverse of the oxygen consumed versus the inverse of the time,
- the oxygen consumption rate corresponds to the inverse of the slope coefficient:

OCR to mg of O₂ per L consumed per day and per g of tannins = 1/A, A being the slope coefficient

In all cases, ellagitannins (or ellagic tannins) should demonstrate an ability to consume the oxygen directly, and more specifically they should be able to consume at least 0.50 ± 0.05 mg of O_2 per litre, per day and per gram of tannins (commercial extract).

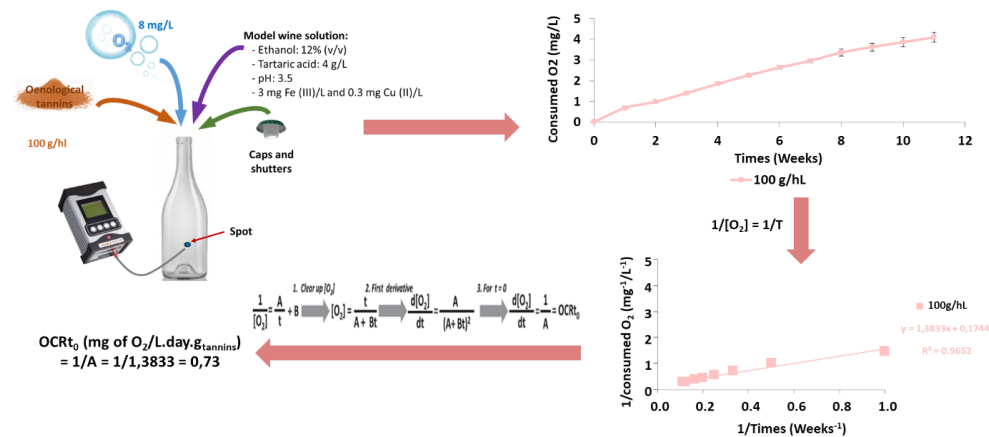

Figure 3: Pathway to determine oxygen consumption rate

2.2. Antioxidasic ability

2.2.1. Principle

Determination of ellagitannins' antioxidasic ability to contribute to antioxidasic protection in terms of the laccase activity of compounds in must and wine.

2.2.2. Products

Ethanol at 96% volume, CAS No. 64-17-5

Tartaric acid: MM = 150.09, CAS No. 87-69-4

Sodium acetate: MM = 82.03, CAS No. 6131-90-4

Syringaldazine (4-hydroxy-3,5-dimethoxybenzaldehyde azine): MM = 360.36, CAS No. 14414-32-5

Polyvinylpolypyrrolidone: PVPP, CAS No. 25249-54-1

Must botrytised with laccase activity

Distilled water (HPLC quality)

2.2.3. Protocols

2 g/L oenological tannin solution: dissolve 200 mg of oenological tannins in 100 mL of model wine solution (distilled water, 12% vol. of ethanol, 4 g/L of tartaric acid and pH adjusted to 3.5).

Buffer solution (8.2 g/L): dissolve 410 mg of sodium acetate in 50 mL of distilled water.

Syringaldazine solution (0.06 g/L): dissolve 30 mg of syringaldazine in 500 mL of ethanol.

2.2.4. Tests

- 1) Add 4 mL of botrytized must to 1 mL of oenological tannin solution in tube, which will correspond to sample modality.
- 2) Add 4 mL of botrytized must to 1 mL of model wine solution in tube, which will correspond to control modality.
- 3) After 4 minutes (precisely), add 0.8 g of PVPP in both tube (sample and control modalities), stirred and centrifuged for 10 minutes at 8,500 rpm.
- 4) Recover 1 mL of the supernatant (for both sample and control modalities), into 1.4 mL of buffer solution and 0.6 mL of syringaldazine solution. Put the mixture into a plastic spectrophotometer cuvette (10 mm path length).
- 5) Measure the absorbance at 530 nm every minute for 5 minutes (including time measurements at 0 minutes).
- 6) Then determine the laccase activity and the residual laccase activity by using the following equations and **Figure 3**:

$$\text{Laccase activity} = 46.15 \times \Delta A \mu\text{mol. L}^{-1}. \text{min}^{-1} = 46.15 \times \Delta A \text{ UL}$$

$$\% \text{ of residual activity} = (\text{laccase activity}_{\text{sample}} / \text{laccase activity}_{\text{control}}) \times 100$$

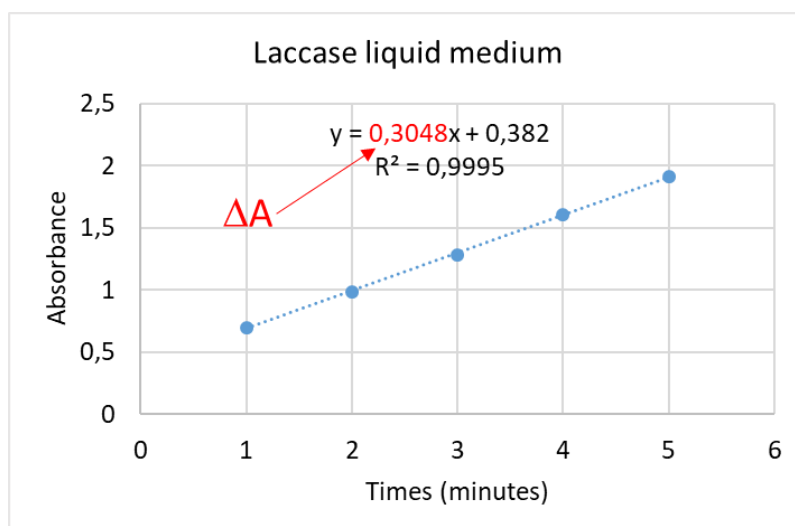

Figure 4: Example determination of ΔA .

In all cases, ellagitannins (or ellagic tannins) should demonstrate an antioxidant ability, and more specifically they should be able to reduce the residual laccase activity by at least 40%. This value is valuable for must and wine containing less than 5 UL (units of laccases).

2.3. Colour stabilization

2.3.1. Principle

Determination of ellagitannins' colour stabilisation properties to promote the expression, stabilisation and preservation of colour in red must and wine.

2.3.2. Products

Ethanol at 96% volume, CAS No. 64-17-5

Tartaric acid: MM = 150.09, CAS No. 87-69-4

Malvidin-3-O-glucoside: MM = 528.87, CAS No. 18470-06-9

2.3.3. Protocols

0.8 g/L oenological tannin solution: dissolve 80 mg of oenological tannins in 100 mL of model wine solution (distilled water, 12% vol. of ethanol, 4 g/L of tartaric acid and pH adjusted to 3.5).

0.1 g/L malvidin-3-O-glucoside solution: dissolve 10 mg of malvidin-3-O-glucoside in 100 mL of model wine solution (distilled water, 12% vol. of ethanol, 4 g/L of tartaric acid and pH adjusted to 3.5).

2.3.4. Tests

- 1) Place 0.75 mL of oenological tannin solution and 0.75 mL of model wine solution in one 2-mL stoppered conical tube – hereinafter a “tube” – and keep it in the dark at room temperature. This tube will be called “T₀”.
- 2) Place 0.75 mL of malvidin-3-O-glucoside solution and 0.75 mL of model wine solution in one tube and keep it in the dark at room temperature. This tube will be called “M”.
- 3) Place 0.75 mL of oenological tannin solution and 0.75 mL of malvidin solution in one tube and keep it in the dark at room temperature. This tube will be called “T_M”.
- 4) After 7 days, measure the absorbance at 450, 520, 570 and 630 nm of the three tubes (T_M, T₀ and M).
- 5) Subtract the absorbance values of T₀ to T_M to obtain the absorbance avoiding the interferences due to the “natural” colour of the oenological tannin.
$$A(T_M) - A(T_0) = A(T)$$
- 6) Then, determine the CIELAB coordinates (L*, a* and b*) corresponding to the tannin solution with malvidin-3-O-glucoside (T) and malvidin-3-O-glucoside solution (M) with the free MSCV software (<https://www.unirioja.es/color/descargas.shtml>) or equivalent.

The formulas to be applied for the calculation of the copigmentation index are as follows:

$$1) \Delta E_{ab} \cdot TS = \sqrt{(L^*_T - L^*_W)^2 + (a^*_T - a^*_W)^2 + (b^*_T - b^*_W)^2}$$

$$2) \Delta E_{ab} \cdot CS = \sqrt{(L^*_M - L^*_W)^2 + (a^*_M - a^*_W)^2 + (b^*_M - b^*_W)^2}$$

$$3) \text{ Copigmentation Index (\%)} = 100 \times \frac{\Delta E_{ab} \cdot TS - \Delta E_{ab} \cdot CS}{\Delta E_{ab} \cdot CS}$$

$\Delta E_{ab} \cdot TS$: total colour difference between the solution of malvidin-3-O-glucoside containing commercial tannins (T) and a pure white colour solution (W).

$\Delta E_{ab} \cdot CS$: total colour difference between the solution of malvidin-3-O-glucoside (M) and a pure white colour solution (W).

The CIELAB coordinates of a pure white colour solution are $L^* = 100.00$, $a^* = 0.00$ and $b^* = 0.00$.

In all cases, ellagitannins (or ellagic tannins) should demonstrate an ability to stabilise the colour, and more specifically their copigmentation index should read as higher than $10.0 \pm 2.0\%$ after 7 days.

Note: Alternative methods of determination can be used in place of any of the methods described, on the condition that these have been internally validated.

3. Bibliography

- Sarneckis, C.J.; Dambergs, R.G.; Jones, P.; Mercurio, M.; Herderich, M.J.; Smith, P.A. Quantification of condensed tannins by precipitation with methyl cellulose: development and validation of an optimised tool for grape and wine analysis. *Australian Journal of Grape Wine Research* **2006**, *12*, 39–49.
- Vignault, A.; González-Centeno, M.R.; Pascual, O.; Gombau, J.; Jourdes, M.; Moine, V.; Iturmendi, N.; Canals, J.M.; Zamora, F.; Teissedre, P.-L. Chemical characterization, antioxidant properties and oxygen consumption rate of 36 commercial oenological tannins in a model wine solution. *Food Chemistry* **2018**, *268*, 210–219.
- Vignault, A.; Pascual, O.; Jourdes, M.; Moine, V.; Fermaud, M.; Roudet, J.; Canals, J.M.; Teissedre, P.-L.; Zamora, F. Impact of enological tannins on laccase activity. *OENO One* **2019**, *53*, 27–38.

- Vignault, A.; Pascual, O.; Gombau, J.; Jourdes, M.; Moine, V.; Canals, J.M.; Teissedre, P.-L.; Zamora, F. Recent advances of the OIV working group on oenological tannins in the study of the functionalities of oenological. *BIO Web of Conferences* **2019**, *15*, 02015.
- Vignault, A.; Gombau, J.; Pascual, O.; Jourdes, M.; Moine, V.; Canals, J.M.; Zamora, F.; Teissedre, P.-L. Copigmentation of Malvidin-3-O-Monoglucoside by Oenological Tannins: Incidence on Wine Model Color in Function of Botanical Origin, pH and Ethanol Content. *Molecules* **2019**, *24*, 1–15.
- Vignault, A.; Gombau, J.; Jourdes, M.; Moine, V.; Canals, J.M.; Fermaud, M.; Roudet, J.; Zamora, F.; Teissedre, P.-L. Oenological tannins to prevent Botrytis cinerea damage in grapes and musts: kinetics and electrophoresis characterization of laccase. *Food Chemistry* **2020**, *316*, 126334.
- Vignault, A. Tanins œnologiques : caractéristiques, propriétés et fonctionnalités. Impact sur la qualité des vins. Thèse de doctorat, Université de Bordeaux et Universitat Rovira i Virgili, **2019**.

OENOLOGICAL TANNINS**Specific monograph for preparations containing gallic tannins**

(OIV-OENO 675C-2022)

Gallotannins, or gallic tannins, are a sub-class of hydrolysable tannins. Oak (and chestnut) galls and tara (*Caesalpinia spinosa*) pod tannins are included in this sub-class.

1. Method for the determination of sub-class affiliations**1.1. Characterisation by high-performance liquid chromatography (HPLC)****1.1.1. Principle**

This method is designed to verify the presence of gallotannins and measure their total concentration.

1.1.2. Reagents, materials and apparatus**1.1.2.1. Reagents**

Gallic acid (purity > 96%), CAS No. 149-91-7
Ultrafiltered water (resistivity: 18.3 M Ω -cm)
Water (HPLC grade)
Methanol (HPLC grade)
Formic acid (HPLC grade)

1.1.2.2. Materials

100-mL borosilicate-glass flask
Filters with 0.45 μ m pore size diameter
Plastic 1-mL syringe

1.1.2.3. Apparatus

Technical balance with precision of \pm 0.01 g
Analytical balance with precision of \pm 0.1 mg
Class-A volumetric glassware

Mass chromatographic system with detection by spectrometry composed of:

- Gradient pump for binary or quaternary mix
- Injector fitted with a loop of 10 μ L
- Spectrophotometric detector at 280 nm fixe wavelength
- Column Phenomenex Kinetex (for example): 150 x 3.0 mm, 2.6 μ m particle size
- ESI-SIM (Single Ion Monitoring mode via Electro Spray Ionisation) ionisation source
- Mass spectrometer detector: triple quadrupole time of flight (Q-ToF)

1.1.3. Preparation of samples and standards

Samples: weigh approximately 0.5 g of oenological tannins on the analytical balance and make a note of the weight. Dissolve the oenological tannins in 100 mL of ultrafiltered water in a 100-mL borosilicate-glass flask and mix well.

Preparation of standard solutions: put 10 mg of gallic acid in solution into 50 mL of ultrafiltered water, corresponding to a 200 mg/L concentration. Then carry out dilutions in ultrafiltered water to obtain 1, 5, 10, 25, 50, 75 and 100 mg/L concentrations.

Solvent A: HPLC-quality water containing 0.1% of formic acid.

Solvent B: methanol containing 0.1% of formic acid.

1.1.4. Procedure

Sample solution and standard solutions are filtered on 0.45 μ m (pore size diameter) cellulose filters and analyse by chromatography under the following conditions given by way of example:

Injected volume: 10 μ L of sample solution or standard solution of gallic acid

Detection at 280 nm

Composition of elution gradient: (time, % of solvent A)

0min, 99.0%; 2 min, 98.0%; 5 min, 97.0%; 6 min, 96.5%; 7 min, 96.0%; 8 min, 95.5%; 10 min, 95.0%; 14 min, 90.0%; 17 min, 85.0%; 23 min, 00%; 25 min, 8.0%; 29 min, 5.0%; 34 min, 1.0%; 45 min, 99.0% and 10 min for equilibrium.

Flow rate: 0.4 mL/min

Quantification and detection of the components of the following gallic tannins: gallic, digallic and quinic acid; 3-, 4- and 5-galloylquinic acid; tri-, tetra-, penta-, hexa-, hepta-, octa-, nona- and decagalloyl-glucose according to the ESI-SIM scan and Q-ToF detection (for example).

Table 1: Example chemical formulas and m/z of the different gallotannins (or gallic tannins)

Compounds	Chemical formula	m/z
Gallic acid	C ₇ H ₆ O ₅	170.0
Digallic acid	C ₁₄ H ₁₀ O ₉	322.2
Quinic acid	C ₇ H ₁₂ O ₆	192.2
3-galloylquinic acid	C ₂₈ H ₂₄ O ₁₈	648.1
4-galloylquinic acid	C ₃₅ H ₂₈ O ₂₂	800.1
5-galloylquinic acid	C ₄₂ H ₃₂ O ₂₆	952.7
Trigalloyl glucose	C ₂₇ H ₂₄ O ₁₈	636.5
Tetragalloyl glucose	C ₂₄ H ₂₈ O ₂₂	788.6
Pentagalloyl glucose	C ₄₁ H ₃₂ O ₂₆	940.6
Hexagalloyl glucose	C ₄₈ H ₃₆ O ₃₀	1092.8
Heptagalloyl glucose	C ₅₅ H ₄₀ O ₃₄	1244.9
Octagalloyl glucose	C ₆₂ H ₄₄ O ₃₈	1396.9
Nonagalloyl glucose	C ₆₉ H ₄₈ O ₄₂	1548.1
Decagalloyl glucose	C ₇₆ H ₅₂ O ₄₆	1707.2

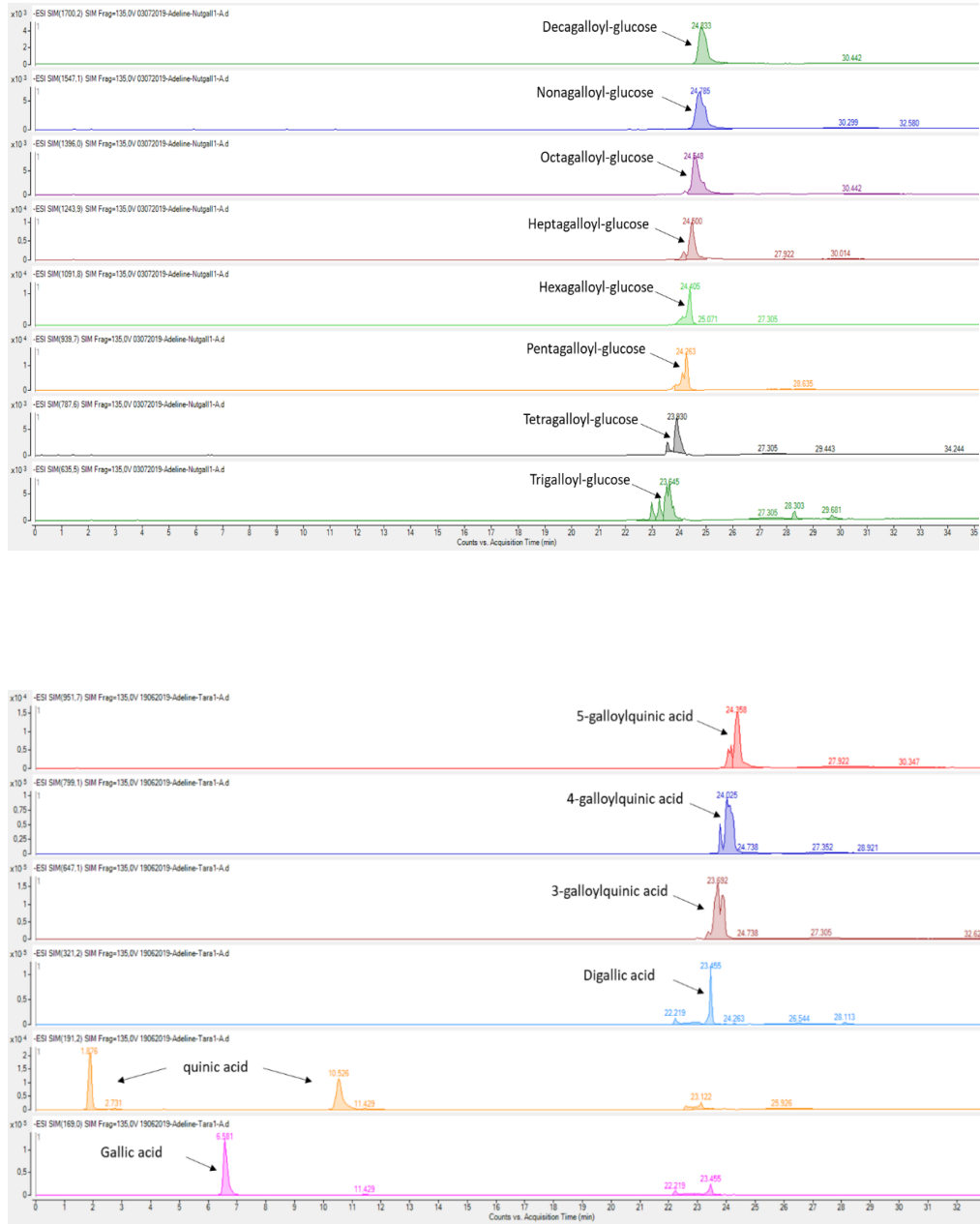

Figure 1: Example ESI-SIM scan of gallotannins (or gallic tannins)

1.2. Conclusion

An oenological tannin is recognised as a gallotannin (or gallic tannin) when:

- its total phenol content is higher than 65% (gravimetric method in Annex 1 of the general monograph OIV-OENO 624-2022),
- its gallotannin content as characterised by the HPLC method is higher than 190 mg equivalent of gallic acid per gram of oenological tannins.

2. Properties and functionalities

The following compliance methods and criteria are only applicable when the property/functionality is claimed on the preparation of tannins.

2.1. Antioxidant ability**2.1.1. Principle**

Determination of gallotannins' antioxidant ability to contribute to the protection of must and wine from oxidation.

2.1.2. Products**2.1.2.1. Antioxidant capacity**

DPPH (2,2-diphenyl-1-picrylhydrazyle): MM = 394.32

Trolox (6-hydroxy-2,5,7,8-tetramethylchroman-2-carboxylic acid):
MM = 250.29

Methanol at 99.9% volume

96-well microplates reader (FLUOstar Omega - BMG Labtech, for example)

2.1.2.2. Direct oxygen consumption (OCR)

Ethanol at 96% volume, CAS No. 64-17-5

Tartaric acid: MM = 150.09, CAS No. 87-69-4

Iron (III) chloride hexahydrate: MM = 270.30, CAS No. 7705-08-0

Copper (II) sulfate pentahydrate: MM = 249.68, CAS No. 7758-98-7

Clear glass bottles with inserted pills of 0.75-cL capacity

NomaSens oximeter, for example

2.1.3. Protocols

2.1.3.1. Antioxidant capacity (DPPH assay)

0.15 g/L oenological tannin solution: dissolve 37.5 mg of oenological tannins in 500 mL of model wine solution (distilled water, 12% vol. of ethanol, 4 g/L of tartaric acid and pH adjusted to 3.5). Dilution of oenological tannins solution could be needed if the measurement absorbance is higher than 1 unit (in this case the dilution should be included in the calculation).

1mM Trolox solution: dissolve 125 mg of Trolox in 500 mL of model wine solution (distilled water, 12% vol. of ethanol, 4 g/L of tartaric acid and pH adjusted to 3.5).

Calibration curve: dissolve in 1, 0.8, 0.6, 0.4, 0.2 and 0.1 mL of 1 mM Trolox solution into 0, 0.2, 0.4, 0.6, 0.8 and 0.9 mL of model wine solution. These quantities correspond to 1, 0.8, 0.6, 0.4, 0.2 and 0.1 mM final concentration of Trolox respectively.

6.10^{-5} M DPPH solution: dissolve 2.36 mg of DPPH in 100 mL of methanol. The solution should be freshly prepared.

2.1.3.2. Direct oxygen consumption (OCR)

1 g/L oenological tannin solution: dissolve 0.75 g of oenological tannin in 750 mL of model wine solution.

Model wine solution: dissolve 4 g of tartaric acid, 2.25 mg of Iron (III) chloride hexahydrate and 0.225 mg of Copper (II) sulfate pentahydrate in 90 mL of ethanol and 660 mL of distilled water. The pH should be adjusted at 3.5.

2.1.4. Tests

2.1.4.1. Antioxidant capacity

First a blank containing solely reagent (RB) is measure at 515 nm by placing 190 μ L of DPPH solution (1.3.1) in all the wells of the plate. Then, add 10 μ L of oenological tannin solution (samples), distilled water (blank) or Trolox curve solution (standards) into the wells and measure (MS) at 515 nm after 30 min.

See Figure 2 for an example of how to fill the plate.

The formula to be applied for the calculation of the antioxidant capacity is as follows:

$$1) \quad RB - MS = x$$

$$2) \quad \frac{antioxidant\ capacity\ (mg\ eq.\ Trolox\ per\ g\ of\ tannins)}{0.15\ (g)} = \frac{250.29\ (mg)}{a} \times \frac{x-b}{a}$$

where “a” and “b” correspond respectively to the slope and the constant of the Trolox calibration curve: Absorbance = f ([Trolox])
 → Absorbance = ax + b

In all cases, gallotannins (or gallic tannins) should demonstrate antioxidant capacity, and more specifically they should have more than 600 ± 50 mg equivalent Trolox per gram of tannins (commercial extract).

	1	2	3	4	5	6	7	8	9	10	11	12
A	T 0.1	T 0.1	T 0.2	T 0.2	T 0.4	T 0.4	T 0.6	T 0.6	T 0.8	T 0.8	T 1	T 1
B	T 0.1	T 0.1	T 0.2	T 0.2	T 0.4	T 0.4	T 0.6	T 0.6	T 0.8	T 0.8	T 1	T 1
C	Blank	OT 1	OT 2	OT 3	OT 4	OT 5	OT 6	OT 7	OT 8	OT 9	OT 10	OT 11
D	Blank	OT 1	OT 2	OT 3	OT 4	OT 5	OT 6	OT 7	OT 8	OT 9	OT 10	OT 11
E	Blank	OT 1	OT 2	OT 3	OT 4	OT 5	OT 6	OT 7	OT 8	OT 9	OT 10	OT 11
F	Blank	OT 1	OT 2	OT 3	OT 4	OT 5	OT 6	OT 7	OT 8	OT 9	OT 10	OT 11
G	Blank	OT 1	OT 2	OT 3	OT 4	OT 5	OT 6	OT 7	OT 8	OT 9	OT 10	OT 11
H	Blank	OT 1	OT 2	OT 3	OT 4	OT 5	OT 6	OT 7	OT 8	OT 9	OT 10	OT 11

T = Trolox

OT = Oenological Tannins

Figure 2: Example 96-well plate

2.1.4.2. Direct oxygen consumption (OCR)

First the model wine solution is saturated with oxygen at 8 mg/L by bubbling with air for 10 min at 20-25 °C. Then, add the oenological tannins to the model wine solution in the bottles filled to 0.75 cL. Seal the bottles hermetically and shake to fully homogenise.

1. Measure the oxygen consumed every two days starting 1h after the filled of the bottles.
2. To determine the oxygen consumption rate, follow the pathway as shown in **Figure 2**:
 - represent the oxygen consumption versus the time,

- then represent the inverse of the oxygen consumed versus the inverse of the time,
- the oxygen consumption rate corresponds to the inverse of the slope coefficient:

OCR t_0 mg of O₂ per L consumed per day and per g of tannins = 1/A, A being the slope coefficient

In all cases, gallotannins (or gallic tannins) should demonstrate an ability to consume the oxygen directly, and more specifically they should be able to consume at least 0.10 ± 0.05 mg of O₂ per litre, per day and per gram of tannins (commercial extract).

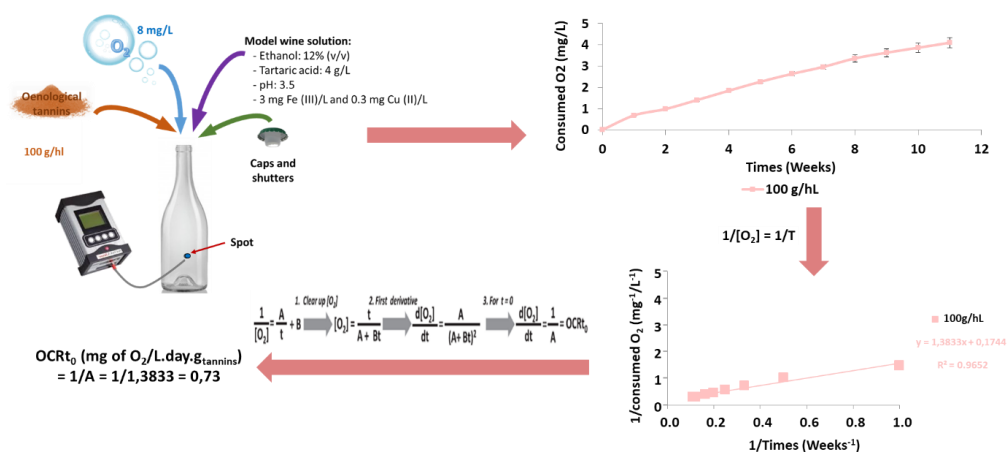

Figure 3: Pathway to determine oxygen consumption rate

2.2. Antioxidasic ability

2.2.1. Principle

Determination of gallotannins' antioxidasic ability to contribute to antioxidasic protection in terms of the laccase activity of compounds in must and wine.

2.2.2. Products

Ethanol at 96% volume, CAS No. 64-17-5

Tartaric acid: MM = 150.09, CAS No. 87-69-4

Sodium acetate: MM = 82.03, CAS No. 6131-90-4

Syringaldazine (4-hydroxy-3,5-dimethoxybenzaldehyde azine): MM = 360.36, CAS No. 14414-32-5

Polyvinylpolypyrrolidone: PVPP, CAS No. 25249-54-1

Must botrytised with laccase activity

Distilled water (HPLC quality)

2.2.3. Protocols

2 g/L oenological tannin solution: dissolve 200 mg of oenological tannins in 100 mL of model wine solution (distilled water, 12% vol. of ethanol, 4 g/L of tartaric acid and pH adjusted to 3.5).

Buffer solution (8.2 g/L): dissolve 410 mg of sodium acetate in 50 mL of distilled water.

Syringaldazine solution (0.06 g/L): dissolve 30 mg of syringaldazine in 500 mL of ethanol.

2.2.4. Tests

- 1) Add 4 mL of botrytised must to 1 mL of oenological tannin solution in tube, which will correspond to sample modality.
- 2) Add 4 mL of botrytised must to 1 mL of model wine solution in tube, which will correspond to control modality.
- 3) After 4 minutes (precisely), add 0.8 g of PVPP in both tube (sample and control modalities), stirred and centrifuged for 10 minutes at 8,500 rpm.
- 4) Recover 1 mL of the supernatant (for both sample and control modalities), into 1.4 mL of buffer solution and 0.6 mL of syringaldazine solution. Put the mixture into a plastic spectrophotometer cuvette (10 mm path length).
- 5) Measure the absorbance at 530 nm every minute for 5 minutes (including time measurements at 0 minutes).
- 6) Then determine the laccase activity and the residual laccase activity by using the following equations and **Figure 3**:

$$\text{Laccase activity} = 46.15 \times \Delta A \mu\text{mol. L}^{-1} \cdot \text{min}^{-1} = 46.15 \times \Delta A \text{ UL}$$

$$\% \text{ of residual activity} = (\text{laccase activity}_{\text{sample}} / \text{laccase activity}_{\text{control}}) \times 100$$

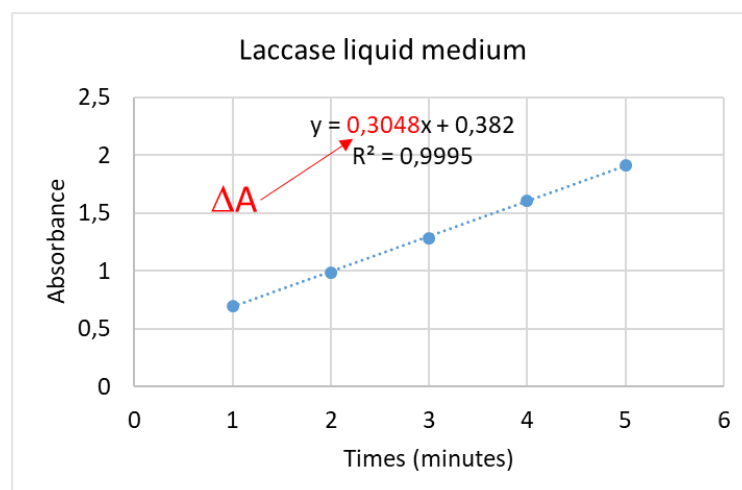

Figure 4: Example determination of ΔA .

In all cases, gallotannins (or gallic tannins) should demonstrate an antioxidasic ability, and more specifically they should be able to reduce the residual laccase activity by at least 50%. This value is valuable for must and wine containing less than 5 UL (units of laccases).

2.3. Colour stabilisation

2.3.1. Principle

Determination of gallotannins colour stabilisation properties to promote the expression, stabilisation and preservation of colour in red must and wine.

2.3.2. Products

Ethanol at 96% volume, CAS No. 64-17-5

Tartaric acid: MM = 150.09, CAS No. 87-69-4

Malvidin-3-*O*-glucoside: MM = 528.87, CAS No. 18470-06-9

2.3.3. Protocols

0.8 g/L oenological tannin solution: dissolve 80 mg of oenological tannins in 100 mL of model wine solution (distilled water, 12% vol. of ethanol, 4 g/L of tartaric acid and pH adjusted to 3.5).

0.1 g/L malvidin-3-O-glucoside solution: dissolve 10 mg of malvidin-3-O-glucoside in 100 mL of model wine solution (distilled water, 12% vol. of ethanol, 4 g/L of tartaric acid and pH adjusted to 3.5).

2.3.4. Tests

- 1) Place 0.75 mL of oenological tannin solution and 0.75 mL of model wine solution in one 2-mL stoppered conical tube – hereinafter a “tube” – and keep it in the dark at room temperature. This tube will be called “T₀”.
- 2) Place 0.75 mL of malvidin-3-O-glucoside solution and 0.75 mL of model wine solution in one tube and keep it in the dark at room temperature. This tube will be called “M”.
- 3) Place 0.75 mL of oenological tannin solution and 0.75 mL of malvidin solution in one tube and keep it in the dark at room temperature. This tube will be called “T_M”.
- 4) After 7 days, measure the absorbance at 450, 520, 570 and 630 nm of the three tubes (T_M, T₀ and M).
- 5) Subtract the absorbance values of T₀ to T_M to obtain the absorbance, avoiding the interferences due to the “natural” colour of the oenological tannin.
 $A(T_M) - A(T_0) = A(T)$
- 6) Then, determine the CIELAB coordinates (L*, a* and b*) corresponding to tannin solution with malvidin-3-O-glucoside (T) and malvidin-3-O-glucoside solution (M) with the free MSCV software (<https://www.unirioja.es/color/descargas.shtml>) or equivalent.

The formulas to be applied for the calculation of the copigmentation index are as follows:

$$1) \Delta E_{ab,TS} = \sqrt{(L^*_T - L^*_W)^2 + (a^*_T - a^*_W)^2 + (b^*_T - b^*_W)^2}$$

$$2) \Delta E_{ab,CS} = \sqrt{(L^*_M - L^*_W)^2 + (a^*_M - a^*_W)^2 + (b^*_M - b^*_W)^2}$$

$$3) \text{ Copigmentation Index (\%)} = 100 \times \frac{\Delta E_{ab,TS} - \Delta E_{ab,CS}}{\Delta E_{ab,CS}}$$

ΔE_{ab} .TS: total colour difference between the solution of malvidin-3-O-glucoside containing commercial tannins (T) and a pure white colour solution (W).

ΔE_{ab} .CS: total colour difference between the solution of malvidin-3-O-glucoside (M) and a pure white colour solution (W).

The CIELAB coordinates of a pure white colour solution are $L^* = 100.00$, $a^* = 0.00$ and $b^* = 0.00$.

In all cases, gallotannins (or gallic tannins) should demonstrate an ability to stabilise the colour, and more specifically their a copigmentation index should read as higher than $30.0 \pm 2.0\%$ after 7 days.

Note: Alternative methods of determination can be used in place of any of the methods described, on the condition that these have been internally validated.

3. Bibliography

- Sarneckis, C.J.; Dambergs, R.G.; Jones, P.; Mercurio, M.; Herderich, M.J.; Smith, P.A. Quantification of condensed tannins by precipitation with methyl cellulose: development and validation of an optimised tool for grape and wine analysis. *Australian Journal of Grape Wine Research* **2006**, *12*, 39–49.
- Vignault, A.; González-Centeno, M.R.; Pascual, O.; Gombau, J.; Jourdes, M.; Moine, V.; Iturmendi, N.; Canals, J.M.; Zamora, F.; Teissedre, P.-L. Chemical characterization, antioxidant properties and oxygen consumption rate of 36 commercial oenological tannins in a model wine solution. *Food Chemistry* **2018**, *268*, 210–219.
- Vignault, A.; Pascual, O.; Jourdes, M.; Moine, V.; Fermaud, M.; Roudet, J.; Canals, J.M.; Teissedre, P.-L.; Zamora, F. Impact of enological tannins on laccase activity. *OENO One* **2019**, *53*, 27–38.
- Vignault, A.; Pascual, O.; Gombau, J.; Jourdes, M.; Moine, V.; Canals, J.M.; Teissedre, P.-L.; Zamora, F. Recent advances of the OIV working group on oenological tannins in the study of the functionalities of oenological. *BIO Web of Conferences* **2019**, *15*, 02015.
- Vignault, A.; Gombau, J.; Pascual, O.; Jourdes, M.; Moine, V.; Canals, J.M.; Zamora, F.; Teissedre, P.-L. Copigmentation of Malvidin-3-O-Monoglucoside

by Oenological Tannins: Incidence on Wine Model Color in Function of Botanical Origin, pH and Ethanol Content. *Molecules* **2019**, *24*, 1–15.

- Vignault, A.; Gombau, J.; Jourdes, M.; Moine, V.; Canals, J.M.; Fermaud, M.; Roudet, J.; Zamora, F.; Teissedre, P.-L. Oenological tannins to prevent *Botrytis cinerea* damage in grapes and musts: kinetics and electrophoresis characterization of laccase. *Food Chemistry* **2020**, *316*, 126334.
- Vignault, A. Tanins œnologiques : caractéristiques, propriétés et fonctionnalités. Impact sur la qualité des vins. Thèse de doctorat, Université de Bordeaux et Universitat Rovira i Virgili, **2019**.

OENOLOGICAL TANNINS**Specific monograph for oenological tannins containing
profisetinidins/prorobitenidins**

(OIV-OENO 675D-2022)

Profisetinidins/prorobitenidins are a sub-class of condensed (or proanthocyanic) tannins. Tannins from the quebracho and acacia *spp.* tree are included in this sub-class.

1. Method for the determination of sub-class affiliations**1.1. Characterisation by high-performance liquid chromatography (HPLC)****1.1.1. Principle**

This method is designed to verify the presence of characteristic components of condensed tannins of the profisetinidin/prorobitenidin sub-group and measure their total concentration. It is applicable to preparations of oenological tannins that are declared as pure and thus as not containing tannins with small masses from different families or sub-families (or classes).

1.1.2. Reagents, material and apparatus**1.1.2.1. Reagents**

(+)-catechin, CAS No. 154-23-4
Ultrafiltered water (resistivity: 18.3 M Ω -cm)
Water (HPLC quality)
Methanol (HPLC quality)
Formic acid (HPLC quality)

1.1.2.2. Materials

100-mL borosilicate-glass flask
Filters with 0.45 μ m pore size diameter
Plastic 1-mL syringe

1.1.2.3. Apparatus

Technical balance with precision of 0.01 g

Analytical balance with precision of 0.1 mg

Class-A volumetric glassware

Mass chromatographic system with spectrometry detection composed of:

- Gradient pump for binary or quaternary mix
- Injector fitted with a loop of 10 µL
- Spectrophotometric detector at 280 nm fixe wavelength
- Column Eclipse Plus C-18 (for example): 2.1 x 100 mm, 1.8 µm particle size
- ESI-SIM (Single Ion Monitoring mode via Electro Spray Ionisation) ionisation source
- Mass spectrometer detector: quadrupole time of flight (Q-TOF)

1.1.3. Preparation of samples and standards

Samples: weigh approximately 0.5 g of oenological tannins on the analytical balance and make a note of the weight. Dissolve the oenological tannins in 100 mL of ultrafiltered water in a 100-mL borosilicate-glass flask and mix well.

Preparation of standard solutions: put 10 mg of (+)-catechin in solution into 50 mL of ultrafiltered water, corresponding to a 200 mg/L concentration. Then carry out dilutions in ultrafiltered water to obtain 5, 10, 20, 40, 60, 80 and 100 mg/L concentrations.

Solvent A: water (HPLC quality) containing 0.1% of formic acid.

Solvent B: methanol containing 0.1% of formic acid.

1.1.4. Procedure

The sample solutions and standard solutions are filtered on 0.45 µm (pore size diameter) filters and analysed by chromatography under the following conditions given by way of example:

Injected volume: 10 µL of sample solution or standard solution of (+)-catechin

Detection at 280 nm

Composition of elution gradient: (time, % of solvent A)

0min, 99.0%; 0.5 min, 94.0%; 20 min, 50.0%; 25 min, 0.0%; 32 min, 94.0% and 10 min for equilibrium.

Flow rate: 0.3 mL/min

Quantification and detection of the characteristic components of condensed tannins from the profisetinidin/prorobitenidin sub-group or sub-class according to the ESI-SIM scan and Q-ToF detection (for example).

Table 1: Example chemical formulas and m/z of the different profisetinidins/prorobitenidins (for the quebracho tree)

Compound	Chemical formula	m/z
(+)-catechin	C ₁₅ H ₁₄ O ₆	290.1
(-)-epicatechin	C ₁₅ H ₁₄ O ₆	290.1
Catechin-fisetinidol dimers	C ₃₀ H ₂₆ O ₁₁	562.1
Catechin-fisetinidol trimers	C ₄₅ H ₃₈ O ₁₆	834.2
Catechin-fisetinidol tetramers	C ₆₀ H ₅₀ O ₂₁	1106.3

Table 2: Example chemical formulas and m/z of the different profisetinidins/prorobitenidins (for the acacia tree)

Compound	Chemical formula	m/z
(+)-catechin	C ₁₅ H ₁₄ O ₆	290.1
(-)-epicatechin	C ₁₅ H ₁₄ O ₆	290.1
(-)-epicatechin-3-O-gallate	C ₂₂ H ₁₈ O ₁₀	442.4
Fisetinidol-gallocatechin dimers	C ₃₀ H ₂₆ O ₁₂	578.1
Robinetinidol-catechin dimers	C ₃₀ H ₂₆ O ₁₂	578.1
Chalcan-flavan dimers (gambiriin)	C ₃₀ H ₂₈ O ₁₂	580.1
Catechine-fisetinidol-robinetinidol or gallocatechin-fisetinidol-fisetinidol trimers	C ₄₅ H ₅₈ O ₁₇	850.2
Robinetinidol-robinetinidol-catechin or gallocatechin-fisetinidol-robinetinidol trimers	C ₄₅ H ₃₈ O ₁₇	866.2

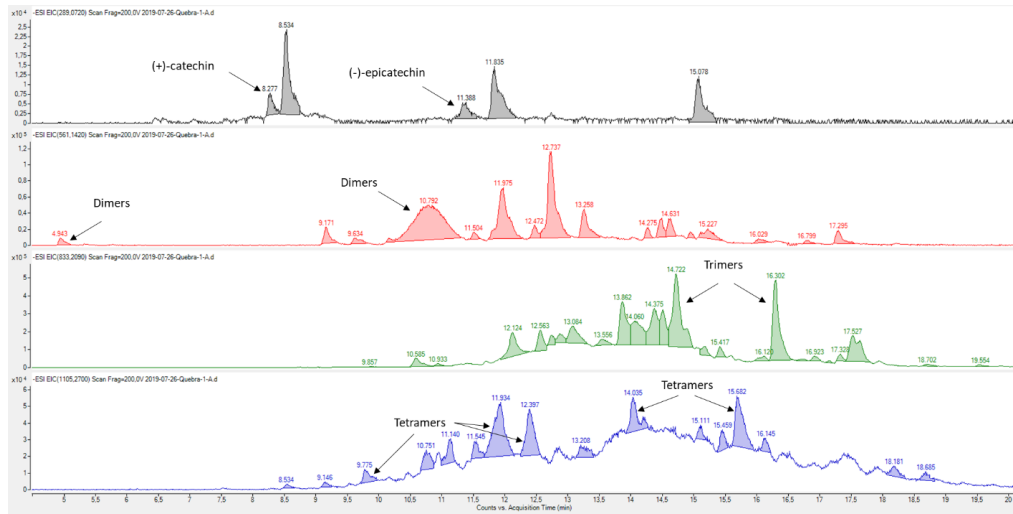

Figure 1: Example ESI-SIM scan of quebracho tree

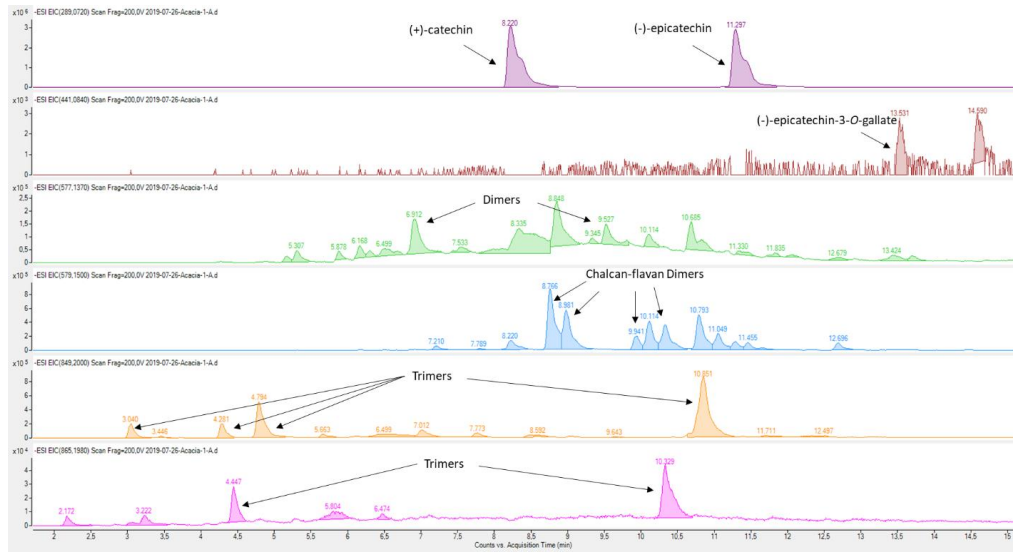

Figure 2: Example ESI-SIM scan of acacia tree

1.2. Conclusion

An oenological tannin is recognised as a profisetinidin/prorobitenidin when:

- its total polyphenol content is higher than 65% (gravimetric method in Annex 1 of the general monograph OIV-OENO 624-2022),
- its molecular procyanidin/prodelphinidin content as characterised by the HPLC method is higher than 20 mg (for quebracho tannins) and 150 mg (for acacia tannins) equivalent of (+)-catechin per gram of oenological tannins.

2. Methods of measurement of properties and functionalities

The following compliance methods and criteria are only applicable when the property/functionality is claimed on the preparation of tannins.

2.1. Antioxidant ability**2.1.1. Principle**

Determination of profisetinidins/prorobitenidins' antioxidant ability to contribute to the protection of must and wine from oxidation.

2.1.2. Products**2.1.2.1. Antioxidant capacity**

DPPH (2,2-diphenyl-1-picrylhydrazyl): MM = 394.32

Trolox (6-hydroxy-2,5,7,8-tetramethylchroman-2-carboxylic acid):
MM = 250.29

Methanol at 99.9% volume

96-well microplate reader (FLUOstar Omega - BMG Labtech, for example)

2.1.2.2. Direct oxygen consumption (OCR)

Ethanol at 96% volume, CAS No. 64-17-5

Tartaric acid: MM = 150.09, CAS No. 87-69-4

Iron (III) chloride hexahydrate: MM = 270.30, CAS No. 7705-08-0

Copper (II) sulfate pentahydrate: MM = 249.68, CAS No. 7758-98-7

Clear glass bottles with inserted pills of 0.75-L capacity

NomaSens oximeter, for example

2.1.3. Protocols

2.1.3.1. Antioxidant capacity (DPPH assay)

0.15 g/L oenological tannin solution: dissolve 37.5 mg of oenological tannins in 500 mL of model wine solution (distilled water, 12% vol. of ethanol, 4 g/L of tartaric acid and pH adjusted to 3.5). Dilution of oenological tannins solution could be needed if the measurement absorbance is higher than 1 unit (in this case the dilution should be included in the calculation).

1mM Trolox solution: dissolve 125 mg of Trolox in 500 mL of model wine solution (distilled water, 12% vol. of ethanol, 4 g/L of tartaric acid and pH adjusted to 3.5).

Calibration curve: dissolve in 1, 0.8, 0.6, 0.4, 0.2 and 0.1 mL of 1 mM Trolox solution into 0, 0.2, 0.4, 0.6, 0.8 and 0.9 mL of model wine solution. These quantities correspond to 1, 0.8, 0.6, 0.4, 0.2 and 0.1 mM final concentration of Trolox respectively.

6.10^{-5} M DPPH solution: dissolve 2.36 mg of DPPH in 100 mL of methanol. The solution should be freshly prepared.

2.1.3.2. Direct oxygen consumption (OCR)

1 g/L oenological tannin solution: dissolve 0.75 g of oenological tannins in 750 mL of model wine solution.

Model wine solution: dissolve 4 g of tartaric acid, 2.25 mg of Iron (III) chloride hexahydrate and 0.225 mg of Copper (II) sulfate pentahydrate in 90 mL of ethanol and 660 mL of distilled water. The pH should be adjusted at 3.5.

2.1.4. Tests

2.1.4.1. Antioxidant capacity

First a blank containing solely the DPPH reagent (RB) is measured at 515 nm by placing 190 μ L of DPPH solution (1.3.1) in all the wells of the plate. Then, add 10 μ L of oenological tannin solution (samples),

distilled water (blank) or Trolox curve solution (standards) into the wells and measure (MS) at 515 nm after 30 min.

See Figure 2 for an example of how to fill the plate.

The formula to be applied for the calculation of the antioxidant capacity is as follows:

$$1) \quad RB - MS = x$$

$$2) \quad \frac{250.29 \text{ (mg)}}{0.15 \text{ (g)}} \times \frac{x-b}{a} = \text{antioxidant capacity (mg eq. Trolox per g of tannins)}$$

where “a” and “b” correspond respectively to the slope and the constant of the Trolox calibration curve: Absorbance = f ([Trolox])
 → Absorbance = ax + b

In all cases, profisetinidins/prorobitenidins should demonstrate an antioxidant capacity, and more specifically they should have more than 450 ± 50 mg equivalent Trolox per gram of tannins (commercial extract).

	1	2	3	4	5	6	7	8	9	10	11	12
A	T 0.1	T 0.1	T 0.2	T 0.2	T 0.4	T 0.4	T 0.6	T 0.6	T 0.8	T 0.8	T 1	T 1
B	T 0.1	T 0.1	T 0.2	T 0.2	T 0.4	T 0.4	T 0.6	T 0.6	T 0.8	T 0.8	T 1	T 1
C	Blank	OT 1	OT 2	OT 3	OT 4	OT 5	OT 6	OT 7	OT 8	OT 9	OT 10	OT 11
D	Blank	OT 1	OT 2	OT 3	OT 4	OT 5	OT 6	OT 7	OT 8	OT 9	OT 10	OT 11
E	Blank	OT 1	OT 2	OT 3	OT 4	OT 5	OT 6	OT 7	OT 8	OT 9	OT 10	OT 11
F	Blank	OT 1	OT 2	OT 3	OT 4	OT 5	OT 6	OT 7	OT 8	OT 9	OT 10	OT 11
G	Blank	OT 1	OT 2	OT 3	OT 4	OT 5	OT 6	OT 7	OT 8	OT 9	OT 10	OT 11
H	Blank	OT 1	OT 2	OT 3	OT 4	OT 5	OT 6	OT 7	OT 8	OT 9	OT 10	OT 11

T = Trolox

OT = Oenological Tannins

Figure 3: Example 96-well plate

2.1.4.2. Direct oxygen consumption (OCR)

First the model wine solution is saturated with oxygen at 8 mg/L by bubbling with air for 10 min at 20-25 °C. Then, add the oenological tannins to the model wine solution in the bottles filled to 0.75 L. Seal the bottles hermetically and shake to fully homogenise.

1. Measure the oxygen consumed every two days starting 1h after the filled of the bottles.
2. To determine the oxygen consumption rate, follow the pathway as shown in Figure 2:

- represent the oxygen consumption versus the time,
- then represent the inverse of the oxygen consumed versus the inverse of the time,
- the oxygen consumption rate corresponds to the inverse of the slope coefficient:

OCR t_0 mg of O_2 consumed per day and per g of tannins = $1/A$, A being the slope coefficient

In all cases, profisetinidins/prorobitenidins should demonstrate an ability to consume the oxygen directly, and more specifically they should be able to consume at least 0.10 ± 0.05 mg of O_2 per litre, per day and per gram of tannins (commercial extract).

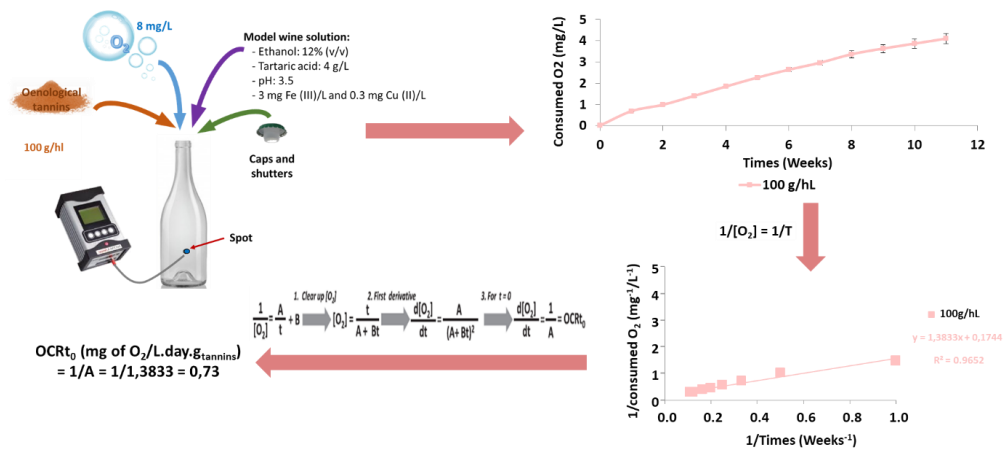

Figure 4: Pathway to determine oxygen consumption rate

2.2. Antioxidasic ability

2.2.1. Principle

Determination of profisetinidins/prorobitenidins' antioxidant ability to contribute to antioxidant protection in terms of the laccase activity of compounds in must and wine.

2.2.2. Products

Ethanol at 96% volume, CAS No. 64-17-5

Tartaric acid: MM = 150.09, CAS No. 87-69-4

Sodium acetate: MM = 82.03, CAS No. 6131-90-4

Syringaldazine (4-hydroxy-3,5-dimethoxybenzaldehyde azine): MM = 360.36, CAS No. 14414-32-5

Polyvinylpyrrolidone: PVPP, CAS No. 25249-54-1

Must botrytised with laccase activity

Distilled water (HPLC quality)

2.2.3. Protocols

2 g/L oenological tannin solution: dissolve 200 mg of oenological tannins in 100 mL of model wine solution (distilled water, 12% vol. of ethanol, 4 g/L of tartaric acid and pH adjusted to 3.5).

Buffer solution (8.2 g/L): dissolve 410 mg of sodium acetate in 50 mL of distilled water.

Syringaldazine solution (0.06 g/L): dissolve 30 mg of syringaldazine in 500 mL of ethanol.

2.2.4. Tests

- 1) Add 4 mL of botrytised must to 1 mL of oenological tannin solution in tube, which will correspond to sample modality.
- 2) Add 4 mL of botrytised must to 1 mL of model wine solution in tube, which will correspond to control modality.
- 3) After 4 minutes (precisely), add 0.8 g of PVPP in both tube (sample and control modalities), stirred and centrifuged for 10 minutes at 8,500 rpm.
- 4) Recover 1 mL of the supernatant (for both sample and control modalities), into 1.4 mL of buffer solution and 0.6 mL of

syringaldazine solution. Put the mixture into a plastic spectrophotometer cuvette (10 mm path length).

- 5) Measure the absorbance at 530 nm every minute for 5 minutes (including time measurements at 0 minutes).
- 6) Then determine the laccase activity and the residual laccase activity by using the following equations and **Figure 3**:

$$\text{Laccase activity} = 46.15 \times \Delta A \mu\text{mol. L}^{-1}. \text{min}^{-1} = 46.15 \times \Delta A \text{ UL}$$

$$\% \text{ of residual activity} = (\text{laccase activity}_{\text{sample}} / \text{laccase activity}_{\text{control}}) \times 100$$

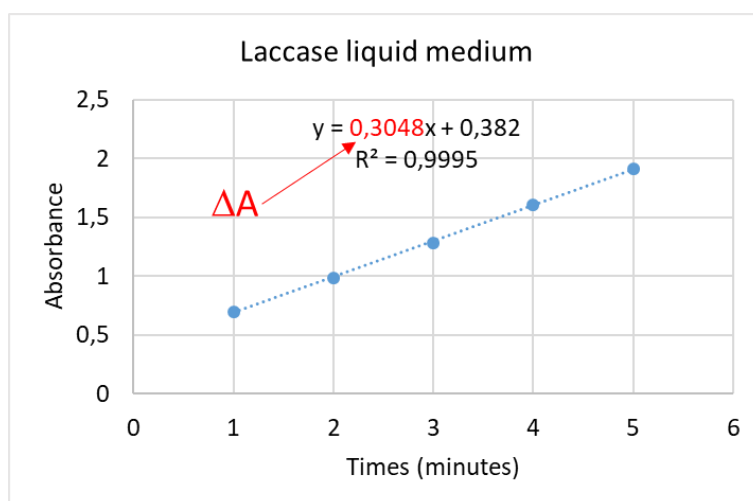

Figure 5: Example determination of ΔA .

In all cases, profisetinidins/prorobitenidins should demonstrate an antioxidasic ability, and more specifically they should be able to reduce the residual laccase activity by at least 40%. This value is valuable for must and wine containing less than 5 UL (units of laccases).

2.3. Colour stabilisation

2.3.1. Principle

Determination of profisetinidins/prorobitenidins' colour stabilisation properties to promote the expression, stabilisation and preservation of colour in red must and wine.

2.3.2. Products

Ethanol at 96% volume, CAS No. 64-17-5

Tartaric acid: MM = 150.09, CAS No. 87-69-4

Malvidin-3-*O*-glucoside: MM = 528.87, CAS No. 18470-06-9

2.3.3. Protocols

0.8 g/L oenological tannin solution: dissolve 80 mg of oenological tannins in 100 mL of model wine solution (distilled water, 12% vol. of ethanol, 4 g/L of tartaric acid and pH adjusted to 3.5).

0.1 g/L malvidin-3-*O*-glucoside solution: dissolve 10 mg of malvidin-3-*O*-glucoside in 100 mL of model wine solution (distilled water, 12% vol. of ethanol, 4 g/L of tartaric acid and pH adjusted to 3.5).

2.3.4. Tests

- 1) Place 0.75 mL of oenological tannin solution and 0.75 mL of model wine solution in one 2-mL stoppered conical tube – hereinafter a “tube” – and keep it in the dark at room temperature. This tube will be called “ T_0 ”.
- 2) Place 0.75 mL of malvidin-3-*O*-glucoside solution and 0.75 mL of model wine solution in one tube and keep it in the dark at room temperature. This tube will be called “M”.
- 3) Place 0.75 mL of oenological tannin solution and 0.75 mL of malvidin solution in one tube and keep it in the dark at room temperature. This tube will be called “ T_M ”.
- 4) After 7 days, measure the absorbance at 450, 520, 570 and 630 nm of the three tubes (T_M , T_0 and M).
- 5) Subtract the absorbance values of T_0 to T_M to obtain the absorbance avoiding the interferences due to the “natural” colour of the oenological tannin.
 $A(T_M) - A(T_0) = A(T)$
- 6) Then, determine the CIELAB coordinates (L^* , a^* and b^*) corresponding to tannin solution with malvidin-3-*O*-glucoside (T) and malvidin-3-*O*-glucoside solution (M) with the free MSCV software (<https://www.unirioja.es/color/descargas.shtml>) or equivalent.

The formulas to be applied for the calculation of the copigmentation index are as follows:

$$1) \Delta E_{ab.TS} = \sqrt{(L^*_T - L^*_W)^2 + (a^*_T - a^*_W)^2 + (b^*_T - b^*_W)^2}$$

$$2) \Delta E_{ab.CS} = \sqrt{(L^*_M - L^*_W)^2 + (a^*_M - a^*_W)^2 + (b^*_M - b^*_W)^2}$$

$$3) \text{ Copigmentation Index (\%)} = 100 \times \frac{\Delta E_{ab.TS} - \Delta E_{ab.CS}}{\Delta E_{ab.CS}}$$

$\Delta E_{ab.TS}$: total colour difference between the solution of malvidin-3-O-glucoside containing commercial tannins (T) and a pure white colour solution (W).

$\Delta E_{ab.CS}$: total colour difference between the solution of malvidin-3-O-glucoside (M) and a pure white colour solution (W).

The CIELAB coordinates of a pure white colour solution are $L^* = 100.00$, $a^* = 0.00$ and $b^* = 0.00$.

In all cases, profisetinidins/prorobitenidins should demonstrate an ability to stabilise the colour, and more specifically their copigmentation index should read as higher than $3.0 \pm 0.5\%$ after 7 days.

Note: Alternative methods of determination can be used in place of any of the methods described, on the condition that these have been internally validated.

3. Bibliography

- Sarneckis, C.J.; Damberg, R.G.; Jones, P.; Mercurio, M.; Herderich, M.J.; Smith, P.A. Quantification of condensed tannins by precipitation with methyl cellulose: development and validation of an optimised tool for grape and wine analysis. *Australian Journal of Grape Wine Research* **2006**, *12*, 39–49.
- Vignault, A.; González-Centeno, M.R.; Pascual, O.; Gombau, J.; Jourdes, M.; Moine, V.; Iturmendi, N.; Canals, J.M.; Zamora, F.; Teissedre, P.-L. Chemical characterization, antioxidant properties and oxygen consumption rate of 36 commercial oenological tannins in a model wine solution. *Food Chemistry* **2018**, *268*, 210–219.

- Vignault, A.; Pascual, O.; Jourdes, M.; Moine, V.; Fermaud, M.; Roudet, J.; Canals, J.M.; Teissedre, P.-L.; Zamora, F. Impact of enological tannins on laccase activity. *OENO One* **2019**, *53*, 27–38.
- Vignault, A.; Pascual, O.; Gombau, J.; Jourdes, M.; Moine, V.; Canals, J.M.; Teissedre, P.-L.; Zamora, F. Recent advances of the OIV working group on oenological tannins in the study of the functionalities of oenological. *BIO Web of Conferences* **2019**, *15*, 02015.
- Vignault, A.; Gombau, J.; Pascual, O.; Jourdes, M.; Moine, V.; Canals, J.M.; Zamora, F.; Teissedre, P.-L. Copigmentation of Malvidin-3-O-Monoglucoside by Oenological Tannins: Incidence on Wine Model Color in Function of Botanical Origin, pH and Ethanol Content. *Molecules* **2019**, *24*, 1–15.
- Vignault, A.; Gombau, J.; Jourdes, M.; Moine, V.; Canals, J.M.; Fermaud, M.; Roudet, J.; Zamora, F.; Teissedre, P.-L. Oenological tannins to prevent Botrytis cinerea damage in grapes and musts: kinetics and electrophoresis characterization of laccase. *Food Chemistry* **2020**, *316*, 126334.
- Vignault, A. Tanins œnologiques : caractéristiques, propriétés et fonctionnalités. Impact sur la qualité des vins. Thèse de doctorat, Université de Bordeaux et Universitat Rovira i Virgili, **2019**.

OXYGEN
O₂ = 32.0
N° SIN: 948
N°CAS = 7727-44-7
OENO 32/2004

1. OBJECT, ORIGIN AND FIELD OF APPLICATION

Gas used for operations of hyperoxygenation of must or oxygenation of wine. It is also used pure or mixed with nitrogen (reconstituted air) during alcoholic fermentation (pumping).

2. LABELLING

The label must mention the nature of the gas and refer to its composition and purity. The safety conditions should also be indicated on the package.

3. CHARACTERISTICS

Colourless, odourless gas without flavour. Non flammable, it supports combustion.

The weight in grams of a litre of oxygen under normal conditions under the pressure of 760 mm of mercury and at 20°C is 1.429 g.

A volume of water dissolves 0.0325 volume of oxygen (44 mg/l). This solubility is 0.049 ml at 0°C (70 mg/l) and a volume of alcohol dissolves 0.1428 volume of oxygen.

It is therefore possible to dissolve 44 ml of oxygen at 20°C in a litre of wine with an alcoholic strength of 12% vol.

In association with nitrogen (air) the maximum solubility of oxygen is 10.27 ml/l in water at 20°C that is about 13.9 ml in a litre of wine whose alcoholic strength is 12% vol.

4. TEST TRIALS

The global purity of the oxygen used in oenology should be above or equal 99% in volume.

Before any measurement, it is advisable to allow the gas to escape for a few minutes in order to purge the piping.

4.1 Chromatographic dosage

Search and determination of gases: nitrogen, carbon monoxide (less than 10 µl/l), argon, carbon dioxide (less than 300 µl/l), etc. are quickly obtained by chromatography in gaseous phase.

4.2 Oxygen dosage

Place a sufficient quantity of ammonium hydroxide and ammonium chloride solution prepared by mixing equal volumes of water and ammonium hydroxide and by saturating with ammonium chloride at room temperature in an apparatus made up of:

- 100 ml burette calibrated with a bi-directional stopcock,
- pipette for gas absorption and
- level vase with an appropriate capacity and all the connections for linking the whole set.

Fill the pipette for gas absorption with copper turnings, wire or metallic lattice or any other appropriate system.

Eliminate all the gas bubbles from the liquid in the testing apparatus. Use the test trial solution two or three times without performing any measurements.

Fill the calibrated burette, all the connections, the two stopcock openings, and the liquid uptake tube.

Entrain 100.0 ml of oxygen in the burette while lowering the level vase.

Open the stopcock facing the absorption pipette and force the oxygen to penetrate in the absorption pipette by lifting the level vase. Shake the pipette in order to favour the close contact of the liquid, gas and copper. Continue shaking until no other decrease in volume occurs.

Entrain the residual gas again in the calibrated burette and measure its volume:

A volume of gas more than 1.0 ml should not remain.

In solution, oxygen can be determined by polarography.

5. PACKAGING

Oxygen is supplied in highly resistant steel cylinders painted white, with needle valves. The resistance of these cylinders must be periodically checked.

PERLITE**CAS no. 93763-70-3****Expanded perlite**

OENO 10/2003

1. OBJECT, ORIGIN, AND FIELD OF APPLICATION

Perlite is a vitreous rock of volcanic origin, belonging to the rhyolite group. Like glass, perlite is made of aluminium silicate and has a chemically bound water content of 1% to 2%.

To be used for oenological purposes, perlite must be dried at 150°C, grinded and then subjected to "expansion" by pre-heating between 200°C to 400°C followed exposing perlite in a flame at 800°C to 1100°C, which provokes swelling and causes a 60-fold increase in size.

Perlite is in white powder form and the final grain size is obtained after being grinded following expansion.

It is a filtration additive for wine.

2. LABELLING

The purity and the storage conditions must be written on the label.

3. LIMITS AND TEST TRIALS**3.1 Odour and taste**

Perlite must not give any foreign odour or taste to the wine. Place 2.5 g of perlite in 1 litre of wine. Shake. Allow to stand 24 hours. Taste and compare to wine without an addition of perlite.

3.2 Loss through desiccation

Place approximately 5 g of perlite in a capsule. Put in an incubator to 103 ± 2 °C. After two hours weight loss must not be over 1%.

3.3 Loss through calcination

Heat the dry residue obtained in point 3.2 in an oven at 550 °C. Weight loss must not be over 3%.

3.4 pH measurement

In a 250 ml recipient, place approximately 10 g of perlite. Pour in slowly, while shaking by hand 100 ml of water to wet the product and obtain a homogenous suspension. Shake by hand from time to time or by using a magnetic stirrer. After 10 minutes, allow the suspension to stand and measure the pH level. Expanded perlite has a pH between 7.5 and 10.

3.5 Soluble products in diluted acids

Bring 10 g of dried perlite with 20 ml of concentrated hydrochloric acid (R) and 100 ml of water to a boil. Gather the perlite on an ashless filter and wash the residue with 100 ml of distilled water. After desiccation at 100°C to 105°C and incineration, and being separated from the insoluble residue filter, it should weigh at least 9.8 g that is 98% of the dry product.

3.6 Preparation of test trial solution

Place 200 ml of citric acid at 5 g per litre brought to pH 3 (R) and 10 g of perlite in a 500 ml flask that can be hermetically sealed. Place on a stirrer and shake 1 hour at a temperature of 20° plus or minus 2°C. Allow to stand, then filter by eliminating the first 50 ml of filtrate. Collect at least 100 ml of clear liquid.

3.7 Iron

Carry out the determination of iron according to the procedure described in Chapter II of the International Oenological Codex using the test trial solutions prepared according to point 3.6. Iron content must be less than 300 mg/kg.

3.8 Lead

Carry out the determination of lead according to the procedure described in Chapter II of the International Oenological Codex using the test trial solution prepared according to point 3.6. Lead content must be less than 5 mg/kg.

3.9 Mercury

Carry out the determination of mercury according to the procedure described in Chapter II of the International Oenological Codex using the test trial solution prepared according to point 3.6.

Mercury content must be less than 1 mg/kg.

3.10 Arsenic

Carry out the determination of arsenic according to the procedure described in Chapter II of the International Oenological Codex using 4 ml of the test trial solution prepared according to point 3.6.

Arsenic content must be less than 5 mg/kg.

3.11 Cadmium

Carry out the determination of cadmium according to the procedure described in Chapter II of the International Oenological Codex using the test trial solution prepared according to point 3.6.

Cadmium content must be less than 1 mg/kg.

4. STORAGE

Perlite must be kept in a well-ventilated dry place in watertight containers under temperate conditions.

**ADSORBENT COPOLYMERS OF POLYVINYLMIDAZOLE
/POLYVINYLPYRROLIDONE (PVI/PVP)****N° C.A.S.: 87865-40-5**

OIV-OENO 262-2014;

OIV-OENO 605-2017

1. OBJECT, ORIGIN AND SCOPE OF APPLICATION

Adsorbent copolymers of PVI/PVP are insoluble and slightly-hygroscopic powders. They are manufactured by "popcorn" polymerization of N-vinylimidazole (CAS no. 1072-63-5,) and N-vinyl-2-pyrrolidone (CAS no. 88-12-0,), with a ratio of 9:1. N,N'-divinylimidazolidin-2-one (CAS no. 13811-50,) is used as crosslinking agent at a level of less than 2% by weight of the total amount of the monomers.

Adsorbent copolymers of PVI/PVP are added to must or wine in accordance with the files described in the Code of Oenological Practices of the OIV in amounts of less than 500 mg/l.

Adsorbent copolymers of PVI/PVP can be added to must or wine in order to prevent the defects caused by excessive metal contents or to reduce undesirably-high metal concentrations.

The must or wine must be filtered through a filter media with pores whose diameter is no greater than 3 microns and with a filtration pressure no greater than 0.8 bars.

2. SYNONYMS

Terpolymer of 1-vinylimidazole, 1-vinylpyrrolidone, and 1,3-divinylimidazolidinone. Cross-linked copolymer of vinylimidazole/vinylpyrrolidone.

3. LABELLING

The labelling must indicate that the PVI/PVP adsorbing copolymer is for oenological use. The storage and safety conditions must also be indicated.

The label must mention a 3-year use-by date.

4. CHARACTERS

Powder with a white to yellowish colour.

PVI/PVP adsorbing copolymers are insoluble in practically all current solvents. It is therefore impossible to measure the molecular weight.

5. TESTS

5.1 Loss on desiccation

Tare a metal capsule 50 mm in diameter. Place in the recipient between 0.8 and 1.4 g of PVI/PVP adsorbent copolymer, homogenised beforehand and weighed precisely in a closed balance. Dry in a drying oven at $140^{\circ}\text{C} \pm 5^{\circ}\text{C}$ for 1 hour. Allow to cool in a desiccator. Weigh again.

The loss on desiccation must be less than 5 %.

5.2 Ash

Heat a porcelain crucible until it is dark red; allow to cool in a desiccator and weigh. Place 1.5 g of PVI/PVP adsorbent copolymer in the crucible and incinerate at a constant weight in a muffle furnace at $800^{\circ}\text{C} \pm 25^{\circ}\text{C}$, allowing the crucible to cool in a desiccator after each incineration, the duration of the first incineration being 6 hours. If necessary, pre-incinerate the sample.

The weight of the ash must be less than 0.02 %.

5.3 Preparation of the solution for tests:

After weighing the ash, dissolve it in 1 ml of concentrated hydrochloric acid (R) and 10 ml of distilled water. Heat to activate dissolution. Make up to 20 ml with distilled water. 1 ml of this solution contains the mineral matter of 0.075 g of PVI/PVP adsorbent copolymer.

5.4 Zinc

Using the solution for tests prepared as in point 5.3, measure zinc according to the method described in Chapter II.

The zinc content must be less than 1 mg/kg.

5.5 Iron

Using the solution for tests prepared as in point 5.3, measure iron according to the method described in Chapter II.

The iron content must be less than 5 mg/kg.

5.6 Copper

Using the solution for tests prepared as in point 5.3, measure copper according to the method described in Chapter II.

The copper content must be less than 1 mg/kg.

5.7 Lead

Using the solution for tests prepared as in point 5.3, measure lead according to the method described in Chapter II.

The lead content must be less than 2 mg/kg.

5.8 Cadmium

Using the solution for tests prepared as in point 5.3, measure cadmium according to the method described in Chapter II.

The cadmium content must be less than 1 mg/kg.

5.9 Arsenic

Do not use the solution for tests prepared as in point 5.3.

Determine the arsenic according to the method described in Chapter II.

The arsenic content must be less than 2 mg/kg.

5.10 Mercury

Do not use the solution for tests prepared as in point 5.3.

Determine the mercury according to the method described in Chapter II.

The mercury content must be less than 1 mg/kg.

5.11 Organic impurities

Determine the organic impurities according to the method described in Appendix 1.

The limits of organic impurities must be as follows:

- The vinylpyrrolidone content must be less than 5 mg/kg
- The vinylimidazole content must be less than 10 mg/kg
- The divinylimidazolidinone content must be less than 2 mg/kg
- The pyrrolidone content must be less than 50 mg/kg
- The imidazole content must be less than 50 mg/kg

5.12 Measurement of total nitrogen

Place approximately 450 mg of PVI/PVP adsorbing copolymer (test portion *m* mg) in a mineralisation flask, add 10 g of Missouri Catalyst¹, and 3 glass beads. Wash all the particles that adhere to the neck of the flask with a small quantity of sulphuric acid (R). Add in total 20 ml of sulphuric acid (R), running it along the walls of the flask, and mix the contents by rotation. Continue the analysis according to the method described in Chapter II.

The total nitrogen content must lie between 26.0 and 29.0% with respect to the dry weight.

¹

Missouri Catalyst (= 49.9% K₂SO₄ + 49.8% Na₂SO₄ + 0.3% CuSO₄), Merck, Darmstadt or the equivalent

5.13 Solubility in an aqueous medium

Place 10 g of PVI/PVP adsorbent copolymer in a graduated 200-ml flask containing 100 ml of water. Shake the bottle and allow the contents to rest for 24 hours. Filter on a filter membrane with 2.5 µm diameter pores, and then on a filter membrane with 0.8 µm diameter pores. The dry residue remaining after evaporation of the filtrate on a water bath must be less than 0.5%.

5.14 Solubility in acid and alcohol

Introduce 1 g of PVI/PVP adsorbent copolymer into a bottle containing 500 ml of the following mixture:

Acetic acid	3 g
Ethanol	10 ml
Water	100 ml

Allow to rest for 24 hours. Filter on a filter membrane with 2.5 µm diameter pores, then on a filter membrane with 0.8 µm diameter pores. Concentrate the filtrate on a water bath. Finish the evaporation on a water bath in a calibrated silica capsule 70mm in diameter. The dry residue remaining after evaporation must be less than 1%, taking into account all the residue of the evaporation of the 500 ml of the mixture of acetic acid, ethanol and water.

5.15 Determination and content of monomers in musts and wines

5.15.1 Analytical method

Proceed with the determination according to the analytical method in Appendix 2

5.15.2 Limits of monomers in musts and wines²

The vinylpyrrolidone content must be less than 10 µg/l

The vinylimidazole content must be less than 10 µg/l

The pyrrolidone content must be less than 25 µg/l

The imidazole content must be less than 150 µg/l

² The calculation of the upper limits was based on the results obtained from the migration tests with the recommended dosage of 0,5 g/l, the maximum application time of 48 hours, and a treatment temperature of 20 °C, multiplied by a factor of 2.

Under acidic conditions (at lower pH-values) divinylimidazolidinone (divinylethylene-urea) is not stable and hence degrades to imidazolidinone and vinyl alcohol. Furthermore imidazolidinone degrades to urea and ethylene glycol. Vinyl alcohol is in chemical equilibrium with acetaldehyde.

Imidazolidinone was included in the toxicological assessment as well as acetaldehyde, urea and ethylene glycol.

6. STORAGE

The PVI/PVP adsorbing copolymer must be kept in a cool place. The recipients must be dry and hermetically sealed.

Appendix 1

Determination by gas chromatography of the constitutive monomers and/or impurities liable to be found in copolymers of vinylpyrrolidone-vinylimidazole (vinylimidazole, vinylpyrrolidone, pyrrolidone, divinylethyleneurea and imidazole)

1. Principle

Detection and determination of the constitutive monomers and/or impurities liable to be found in copolymers of vinylpyrrolidone-vinylimidazole (vinylimidazole, vinylpyrrolidone, pyrrolidone, divinylethyleneurea and imidazole).

The analysis is carried out by capillary gas chromatography using a nitrogen specific detector (NSD). The substances to be analysed are extracted beforehand from the polymer by acetone.

2. Range of contents to be determined

Vinylimidazole:	2-55 µg/g
Vinylpyrrolidone:	2-50 µg/g
Pyrrolidone:	2-70 µg/g
Divinylethyleneurea:	2-33 µg/g
Imidazole:	2-50 µg/g

3. Reagents and reference material

3.1 Vinylpyrrolidone-vinylimidazole copolymers;

3.2 Vinylimidazole, $M(C_5H_6N_2) = 94.12$ g/mol
purity > 99% (GC), e.g. Fluka, item no. 95005
(R: 22-34, S: 26-36/37/39-45)

3.3 Vinylpyrrolidone (*1-vinyl-2-pyrrolidone*), $M(C_6H_9NO) = 111.14$ g/mol
purity = 99.8% (GC), e.g. Fluka, item no. 95060
(R: 20/21/22-36/37/38-40, S: 26-36/37/39)

3.4 Pyrrolidone, (*2-pyrrolidone*), $M(C_4H_7NO) = 85.11$ g/mol
purity > 99% (GC), e.g. Fluka, item no. 83300
(R: 36/37/38, S: 26-36)

3.5 Divinylethyleneurea (*N,N-divinylimidazolidone*), $M(C_7H_{10}N_2O) = 138.17$ g/mol
purity ≥ 99% (GC), BASF reference material

(R: 36/38-40, S: 26-36/37)

- 3.6 Imidazole, ($C_3H_4N_2$) = 68.08 g/mol
purity > 99.5% (GC), e.g. Fluka, item no. 56748
(R: 22-34, S: 26-36/37/39-45)
- 3.7 Benzonitrile,
purity > 99% (G), e.g. Merck-Schuchardt, item no. 801800
(R: 10-35, S: 23-26-45)
- 3.8 Acetone,
purity \geq 99% (GC), e.g. Fluka, item no. 00585
(R: 11, S: 9-16-23-33)

4. Apparatus

- 4.1 Capillary gas chromatograph with an automatic sampler, split injector, nitrogen specific detector (NSD).
- 4.2 Fused silica capillary column, with a polyethylene glycol film, (e.g. DB-Wax, J&W Scientific)
Length: 30 m
Internal diameter: 0.25 mm
Film thickness: 0.5 μ m
- 4.3 Data acquisition and processing system
- 4.4 Analytical balance accurate to 0.1 mg
- 4.5 Laboratory glassware and standard apparatus
- 4.6 Rotary mixer capable of housing small-capacity flasks, e.g. 50 ml.

5. Solutions

- 5.1 Internal standard solution
Benzonitrile, 250 μ g/ml in acetone (3.8)
- 5.2 Stock calibration solution
Prepare a stock calibration solution of different concentrations in acetone (3.8) containing vinylimidazole, vinylpyrrolidone, pyrrolidone, divinylethyleneurea and imidazole with amounts ranging from 250 mg/l to 1000 mg/l.

5.3 Calibration solutions

Prepare at least two calibration solutions with different concentrations in acetone (3.8). Each solution must contain a suitable quantity of the internal standard as well as vinylimidazole, vinylpyrrolidone, pyrrolidone, divinylethyleneurea and imidazole so that the calibration points include the values currently being measured.

Example: 4 µl-200 µl of stock solution (5.2) + 24 ml of acetone (3.8) + 1 ml of internal standard solution (5.1).

6. Example of chromatographic conditions

Temperatures:

Injector:	220°C
Oven:	160°C
- then programmed at a rate of 5°C/min up to 210°C	
Final isothermal period:	210°C, 7 min
Detector (NSD):	250°C

Carrier gas:	helium
Column head pressure:	140 kPa (1.4 bar)
Split flow:	10 ml/min
Septum purge:	5 ml/min
Volume injected:	1.0 µl

7. Preliminary check of the analytical system

7.1 Resolution

Prepare a solution of benzonitrile and vinylimidazole (10 and 2 µg/ml in acetone).

Inject this solution into the chromatograph under the conditions described in 6.

The analysis is considered satisfactory when the resolution of the two chromatographic peaks is at least 1.5 ($R > 1.5$), with a return to the baseline between the two peaks.

7.2 Sensitivity

To check the sensitivity:

- 1) Carry out a preliminary analysis of a sample (8.1) under the conditions described in section 6.
- 2) Add to the sample 2 µg/g divinylethyleneurea then repeat the analysis under the conditions described in section 6.

If the sample does not contain divinylethyleneurea the system is suitable when the peak of added divinylethyleneurea presents a signal-to-noise ratio of at least 10.

If the sample contained divinylethyleneurea a clear increase in the signal should be observed.

8. Procedure

8.1 Preparation of the samples

Weigh about 2g of sample, accurate to 0.1 mg, then mix it with 1 ml of internal standard solution (5.1) and 24 ml of acetone (3.8). Extract the sample for 4 h on the rotary mixer (4.6) then analyse the supernatant solution under the conditions described in point 6.

For routine determinations, analyse each sample twice.

8.2 Chromatograms

Extracted by acetone from a copolymer (fig. 1)

Extracted by acetone from a copolymer supplemented with analytes (fig. 2)

9. Calculation

9.1 Calibration factor

Chromatographic calibration factor $f(i)$:

$$f(i) = \frac{A(i)_0 \times m(I.S.)_0}{m(i)_0 \times A(I.S.)_0}$$

where:

$A(i)_0$ = peak area of analyte i in the chromatogram for the calibration solution (mVs)

$m(i)_0$ = initial weight of reference product i in the calibration solution [mg]

$A(I.S.)_0$ = peak area of the internal standard in the chromatogram of the calibration solution (mVs)

$m(I.S.)_0$ = initial weight of the internal standard in the calibration solution [mg]

The weight ratio $w(i)$ of analyte i is calculated in the following way:

$$w(i) = \frac{A(i) \times m(I.S.)}{A(I.S.) \times m(s) \times f'(i)}$$

where:

$w(i)$ = weight ratio of the analyte i [$\mu\text{g/g}$]

$A(i)$ = peak area of the analyte I in the chromatogram of the sample solution (mVs)

$A(\text{I.S.})$ = peak area of the internal standard in the chromatogram of the sample solution (mVs)

$m(\text{I.S.})$ = initial weight of the internal standard added to the sample [μg]

$m(s)$ = initial weight of sample [g]

$f'(i)$ = average chromatographic calibration factor

For routine determinations, the result is expressed as a whole number.

10. Characteristics of the method

10.1 Specificity, selectivity

In the chromatogram, the peaks are identified according to their retention time in comparison with the retention time of the solutions of pure analytes (3.2 to 3.6) injected under the same conditions.

Check that the components of the sample have a retention time different from that of the internal standard and that the resolution between peaks is always greater than 1.5.

10.2 Linearity

During calibration, the calibration factors were determined at 6 levels of concentration for each analyte. The calibration curves are straight lines (cf. fig. 3-7) with the following coefficients of determination:

Vinylimidazole $R^2 = 0.9987$

Vinylpyrrolidone $R^2 = 0.9999$

Pyrrolidone $R^2 = 0.9956$

Divinylethyleneurea $R^2 = 0.9937$

Imidazole $R^2 = 0.9982$

10.3 Limit of quantification

The calibration measurements were used to determine the following limits of quantification:

Vinylimidazole: 2 $\mu\text{g/g}$

Vinylpyrrolidone: 2 $\mu\text{g/g}$

Pyrrolidone: 2 $\mu\text{g/g}$

Divinylethyleneurea: 2 $\mu\text{g/g}$

Imidazole: 2 µg/g

10.4 Precision

To determine the precision under repeatability conditions, a copolymer sample was analysed 6 times: (Table 1)

Table 1

		Vinylimidazole	Vinylpyrrolidone	Pyrrolidone	Divinylethyleneurea	Imidazole
1. Determination	[µg/g]	nq*	nd**	4.1	nd	10.7
2. Determination	[µg/g]	nq	nd	4.3	nd	10.8
3. Determination	[µg/g]	nq	nd	4.2	nd	11.5
4. Determination	[µg/g]	nq	nd	4.3	nd	11.8
5. Determination	[µg/g]	nq	nd	3.9	nd	10.2
6. Determination	[µg/g]	nq	nd	3.9	nd	10.8
Average	[µg/g]	nq	nd	4.1	nd	11.0
Standard deviation	[µg/g]			0.2		0.6
Coeff. of variation	%			4.8		5.1
Measurement uncertainty	[µg/g]			0.6		1.7
Relative measurement uncertainty	%			14		15

*nq = not quantifiable

**nd= not detectable

In the sample, the vinylpyrrolidone and divinylethyleneurea could not be detected and the vinylimidazole could not be quantified.

10.4.1 Repeatability

The copolymer sample was supplemented with all the analytes then analysed 6 times. The accuracy under repeatability conditions can be deduced from the repeatability for vinylpyrrolidone, divinylethyleneurea and vinylimidazole. (Table 2)

Table 2

		Vinylimidazole	Vinylpyrrolidone	Pyrrolidone	Divinylethyleneurea	Imidazole
1. Determination	[%]	102.3	112.4	97.0	103.3	90.7
2. Determination	[%]	98.5	101.9	89.6	102.1	91.7
3. Determination	[%]	111.8*	111.5	105.7	111.1	112.6*
4. Determination	[%]	102.7	103.3	91.9	104.8	94.5
5. Determination	[%]	104.2	101.0	89.3	102.7	97.0
6. Determination	[%]	100.4	104.9	90.4	110.3	95.4
Average	[%]	101.6	105.8	94.0	105.7	93.9
Standard deviation	[%]	2.2	4.9	6.4	3.9	2.6
Coeff. of variation	[%]	2.2	4.7	6.8	3.7	2.8
Measurement uncertainty	[%]	6.6	14.8	19.2	11.8	7.8
Relative measurement uncertainty	[%]	7	14	20	11	8

* = outlier value according to the Dixon test

10.5 Addition recovery

The recovery can be calculated from table 2.

Vinylimidazole: 101.6 %

Vinylpyrrolidone: 105.8 %

Pyrrolidone: 94.0 %

Divinylethyleneurea: 105.7 %

Imidazole: 93.9 %

Note

Applicability to other copolymers of vinylpyrrolidone-vinylimidazole

The method was validated for Divergan HM. In principle, we can consider the determination is also valid for other copolymers of vinylpyrrolidone-vinylimidazole.

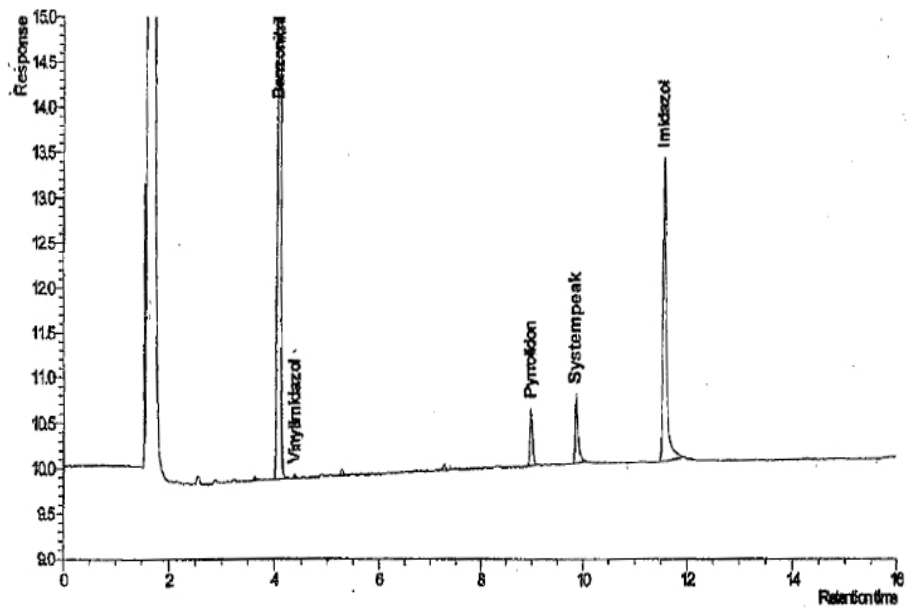

Fig. 1: Chromatogram of the copolymer extract (with internal standard)

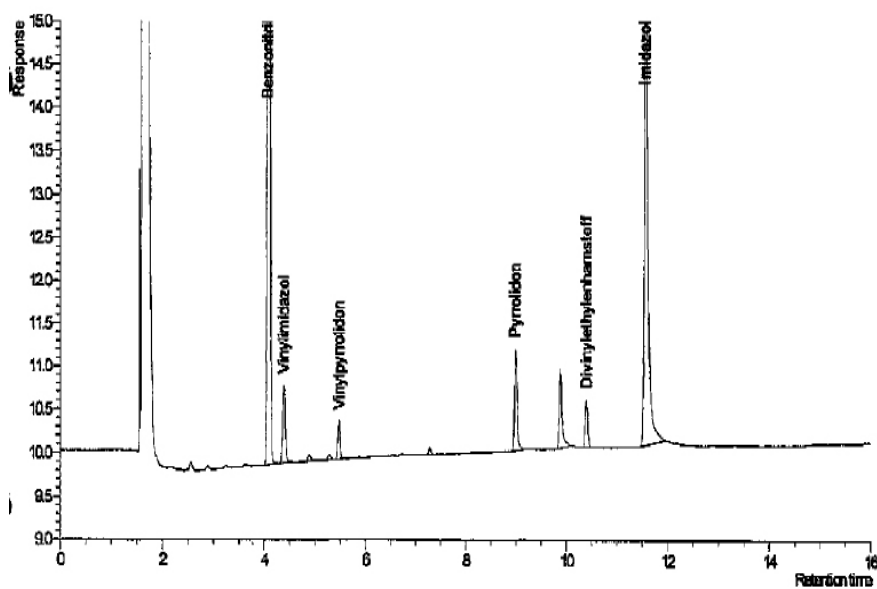

Fig. 2 Chromatogram of the copolymer extract (with internal standard), supplemented by 2.1 $\mu\text{g/g}$ of vinylimidazole, 2.1 $\mu\text{g/g}$ of vinylpyrrolidone, 3.9 $\mu\text{g/g}$ of pyrrolidone, 2.1 $\mu\text{g/g}$ of divinylethyleneurea, and 12.7 $\mu\text{g/g}$ of imidazole.

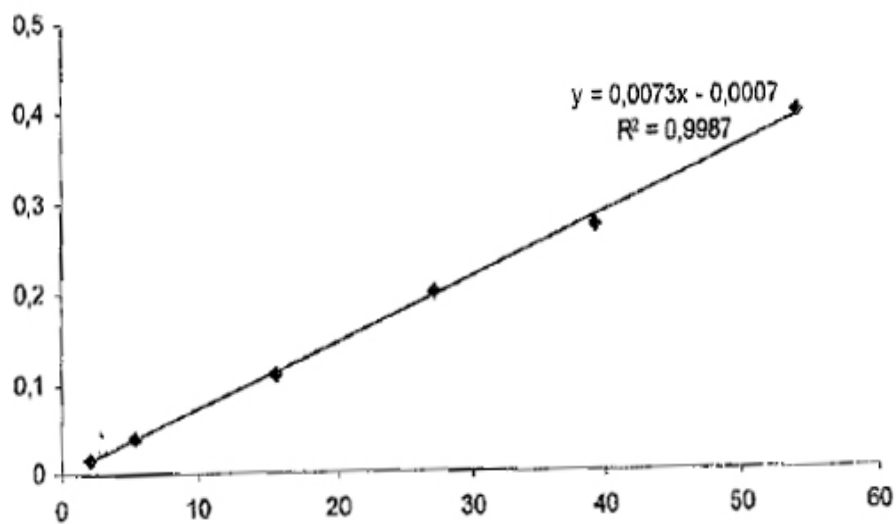

Fig. 3: calibration line for vinylimidazole

Analyte peak area*test sample (int. std.)

Peak area (int. std.) [mg]

Analyte test sample related to standard test sample [µg/g]

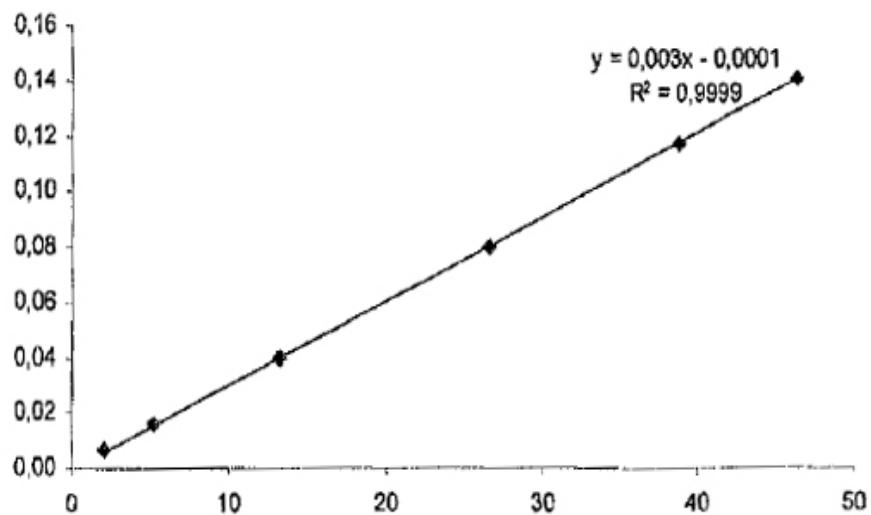

Fig. 4: calibration line for vinylpyrrolidone

Analyte peak area*test sample (int. std.)

Peak area (int. std.) [mg]

Analyte test sample related to standard test sample [$\mu\text{g/g}$]

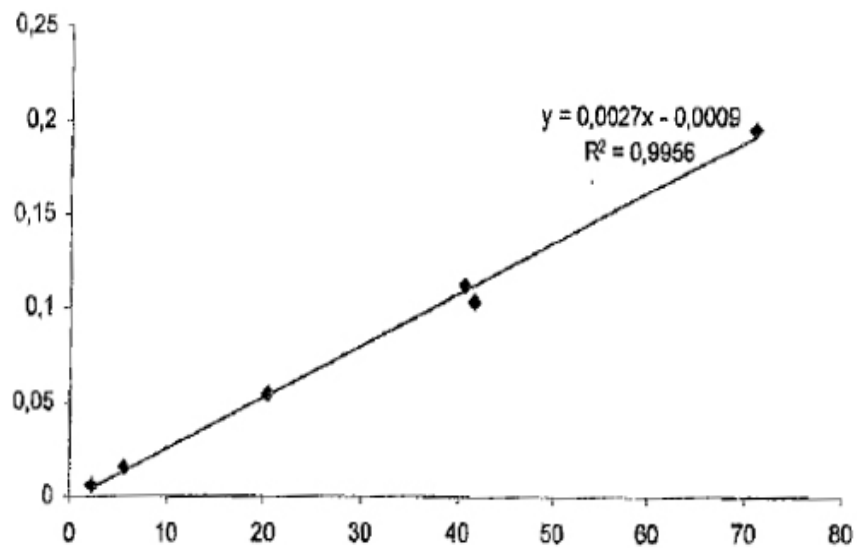

Fig. 5: calibration line for pyrrolidone

Analyte peak area*test sample (int. std.)

Peak area (int. std.) [mg]

Analyte test sample related to standard test sample [µg/g]

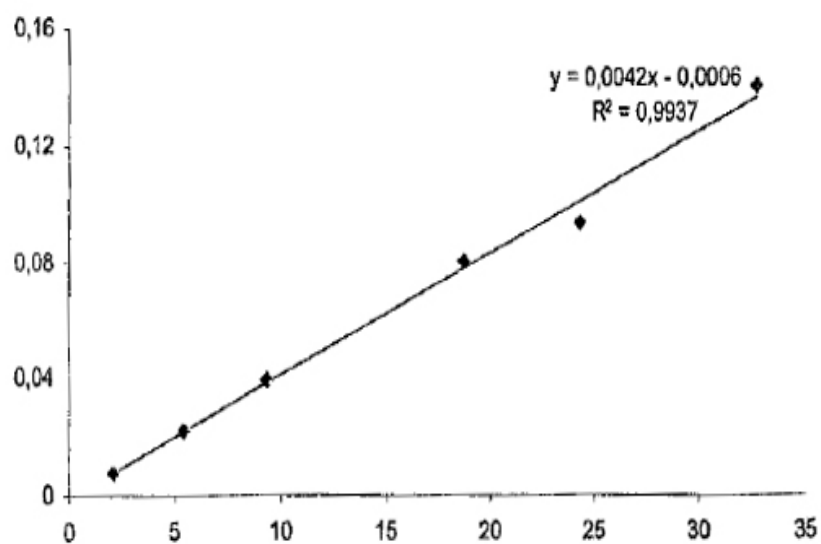

Fig. 6: calibration line for divinylethyleneurea

Analyte peak area*test sample (int. std.)

Peak area (int. std.) [mg]

Analyte test sample related to standard test sample [µg/g]

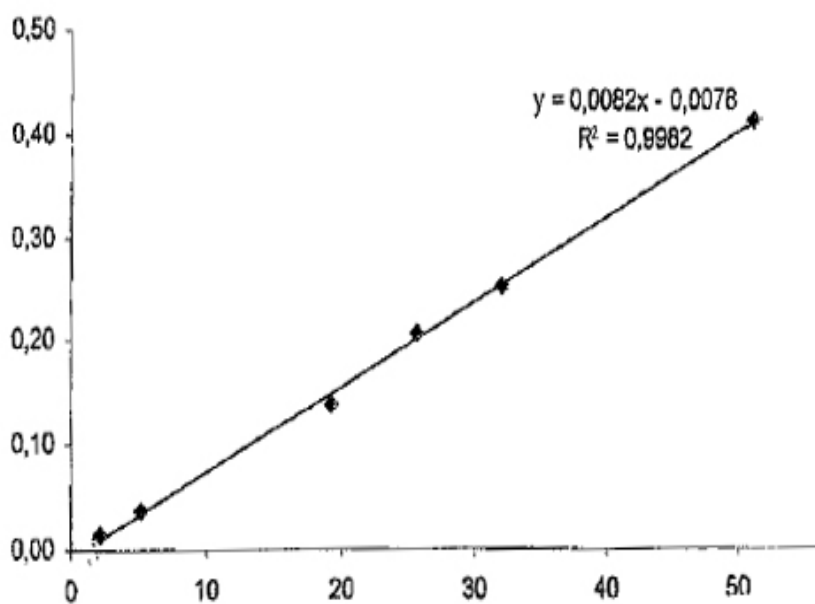

Fig. 7: calibration line for imidazole

Analyte peak area*test sample (int. std.)

Peak area (int. std.) [mg]

Analyte test sample related to standard test sample [µg/g]

Appendix 2

Analytical method for the detection of Imidazole, Pyrrolidone and residual monomers (Vinylpyrrolidone, Vinylimidazole, Divinylimidazolidinone) in wines and musts

1 Scope

The method described here is suitable for the determination of Imidazole, Pyrrolidone, Vinylimidazole and Vinylpyrrolidone in white, red, sweet and dry wines, and must.

Divinylimidazolidinone has a half-life of 3.75 min at pH-value of 3.7. Thus determination is not appropriate in wine and must.

The study described covers the concentration ranges of 5 to 125 µg/l for Imidazole, 25 to 250 µg/l for Pyrrolidone, 2 to 25 µg/l for Vinylimidazole and 2 to 12.5 µg/l for Vinylpyrrolidone.

2 Definitions

HPLC High performance liquid chromatography

LC-MS Liquid Chromatography – Mass spectrometry

MRM multiple-reaction monitoring

3 Principle

Samples are analyzed directly by LC-MS on a reversed-phase column (C18). Detection is then carried out in multiple-reaction monitoring mode.

4 Reagents and Materials

4.1 Chemicals

4.1.1 Methanol (LiChrosolv) (CAS: 67-56-1) quality for CL-SM

4.1.2 Bidistilled water

4.1.3 Heptafluorobutyric acid, puriss., ≥99,5% (CAS: 375-22-4)

4.2 Preparation of eluents

- 4.2.1** Solvent A:
Pipette 0.6 ml of heptafluorobutyric acid (4.1.3) into 1000 ml bidistilled water (4.1.2), shake and degas.
- 4.2.2** Solvent B:
Add 300 ml of bidistilled water (4.1.2) to 700 ml of methanol (4.1.1) and shake. Pipette 0.6 ml of heptafluorobutyric acid (4.1.3) into this solution, shake and degas.

4.3 Standards

- 4.3.1** Imidazole, $\geq 99,5$ % (CAS: 288-32-4)
- 4.3.2** Pyrrolidone, ≥ 99 % (CAS: 616-45-5)
- 4.3.3** Vinylimidazole, ≥ 99 % (CAS: 1072-63-5)
- 4.3.4** Vinylpyrrolidone, $\approx 99,8$ % (CAS: 88-12-0)

4.4 Preparation of standard solutions

- 4.4.1** Preparation of the stock standard solutions (1,00 g/l):
Weigh exactly 100 mg of standards (4.3.1-4.3.4), transfer them without loss into a 100 ml volumetric flask, fill with bidistilled water (4.1.2) to about 90 ml, shake and adjust to 100 ml.
- 4.4.2** Preparation of the mixed standard solution (Imidazole: 62.5 mg/l; Pyrrolidone: 62.5 mg/l; Vinylimidazole: 12.5 mg/l; Vinylpyrrolidone: 6.25 mg/l):
Pipette 6.25 ml of the Imidazole stock solution (4.4.1), 6.25 ml of the Pyrrolidone stock solution (4.4.1), 1.25 ml of the Vinylimidazole stock solution (4.4.1) and 0.625 ml of the Vinylpyrrolidone stock solution (4.4.1) to a 100 ml volumetric flask, fill with bidistilled water (4.1.2) to about 90 ml, shake and adjust to 100 ml.
- 4.4.3** Preparation of the working standard solution:
Pipette 40 μ l mixed standard solution (4.4.2) to a 25-ml volumetric flask, fill with bidistilled water to 25 ml and shake.

4.5 Preparation of the matrix calibration curve

Matrix-matched calibration solutions are prepared in an uncontaminated wine or must. Dilute the mixed standard solution (4.4.2) appropriately with the sample to give five working standards.

Calibration standards must be prepared just before measurement!

end volume	mixed standard	Imidazole	Pyrrolidone	Vinylimidazole	Vinylpyrrolidone
25 ml	0 µl	0 µg/l	0 µg/l	0 µg/l	0 µg/l
25 ml	10 µl	25 µg/l	25 µg/l	5 µg/l	2.5 µg/l
25 ml	20 µl	50 µg/l	50 µg/l	10 µg/l	5 µg/l
25 ml	30 µl	75 µg/l	75 µg/l	15 µg/l	7.5 µg/l
25 ml	40 µl	100 µg/l	100 µg/l	20 µg/l	10 µg/l
25 ml	50 µl	125 µg/l	125 µg/l	25 µg/l	12.5 µg/l

5 Apparatus

- 5.1 Analytical balance accurate to 0.1mg
- 5.2 Assorted precision pipettes and volumetric flasks
- 5.3 HPLC vials (4 ml)
- 5.4 High-performance liquid chromatograph with mass spectrometric detector (Applied Biosystems API 4000 or equivalent)
- 5.5 Knauer Eurospher 100-5 C18 column with an integrated pre-column or equivalent
Internal diameter: 4.6 mm
Length: 250 mm
Stationary Phase: C18, pore size: 100 Å, particle size: 5 µm, end-capped

6 Sample preparation

6.1 Model wine Solution

The model wine solution is prepared according to Martínez-Rodríguez and Polo, 2000 (Characterization of the Nitrogen Compounds Released during Yeast Autolysis in a Model Wine System).

Four grams of tartaric acid, 0.1 g of acetic acid, and 120 mL of ethanol are dissolved in 800 mL of water (bidistilled). After adjustment of the pH value to 3.2 with 2N sodium hydroxide, the solution is made up to 1000 mL. The model wine solution is brought to temperature at 20°C.

6.2 *Sample preparation for migration analysis*

The amount of 0.5 grams Divergan HM are added to 1 litre of model wine solution and stirred at 20°C for 48 hours (at approximately 150 rpm).

Prior to analysis the sample is centrifuged (approximately 3 min, 4500 rpm) and filtered through a 0.45 µm membrane filter.

6.3 *Other samples (e.g. musts and wines)*

Clear samples are filled directly into sample vials and ready for chromatography without any sample preparation. Cloudy wine samples are filtered through a 0.45 µm membrane filter before injection, and the first fractions of filtrate are discarded.

7 LC-MS Analysis**7.1 Operating conditions for HPLC:**

Injection volume: 10 µl

Flow rate: 1 ml/min

Gradient:

85 : 15 (A : B) $\xrightarrow{10 \text{ min}}$ 85 : 15 $\xrightarrow{5 \text{ min}}$ 0 : 100 $\xrightarrow{10 \text{ min}}$ 0 : 100
 $\xrightarrow{5 \text{ min}}$ 85 : 15 $\xrightarrow{15 \text{ min}}$ 85 : 15

Column heater: 25 °C

Run time: 45 min

7.2 MS conditions:

Mass spectrometer: Applied Biosystems API 4000 or equivalent

Scan Type: MRM

Polarity: Positive

Ion Source: Turbo Spray

Duration: 20,005 min; 1364 Cycles

Curtain Gas: 40 psi

Ionspray Voltage: 2500 V

Temperature: 550 °C

Ion Source Gas 1: 60 psi

Ion Source Gas 2: 60 psi

Collision Gas: Medium

Entrance Potential: 10 V

Collar 2: 0

compound	Q1 Mass (amu)	Q3 mass (amu)	Dwell (msec)	Parameter	Start	Stop
Imidazole	69.08	42.20	75.00	DP	81.00	81.00

				CE	31.00	31.00
				CXP	2.00	2.00
Pyrrolidone	86.10	44.10	75.00	DP	66.00	66.00
				CE	31.00	31.00
				CXP	6.00	6.00
	86.10	69.00	75.00	DP	66.00	66.00
				CE	23.00	23.00
				CXP	4.00	4.00
Vinylimidazole	95.09	41.10	75.00	DP	71.00	71.00
				CE	33.00	33.00
				CXP	0.00	0.00
	95.09	69.20	75.00	DP	71.00	71.00
				CE	29.00	29.00
				CXP	12.00	12.00
Vinylpyrrolidone	112.08	69.20	75.00	DP	51.00	51.00
				CE	21.00	21.00
				CXP	4.00	4.00
	112.08	84.00	75.00	DP	51.00	51.00
				CE	17.00	17.00
				CXP	14.00	14.00

DP: Declustering Potential (in volts)
 CE: Collision Energy (in volts)
 CXP: Collision Cell Exit Potential (in volts)

8 Evaluation

8.1 Identification:

Inject 10 µl of working standard solution (4.4.3) to ascertain the retention times. Approximate retention times are:

compound	retention time
Imidazole	7.45 min
Pyrrolidone	8.37 min
Vinylimidazole	14.43 min
Vinylpyrrolidone	17.64 min

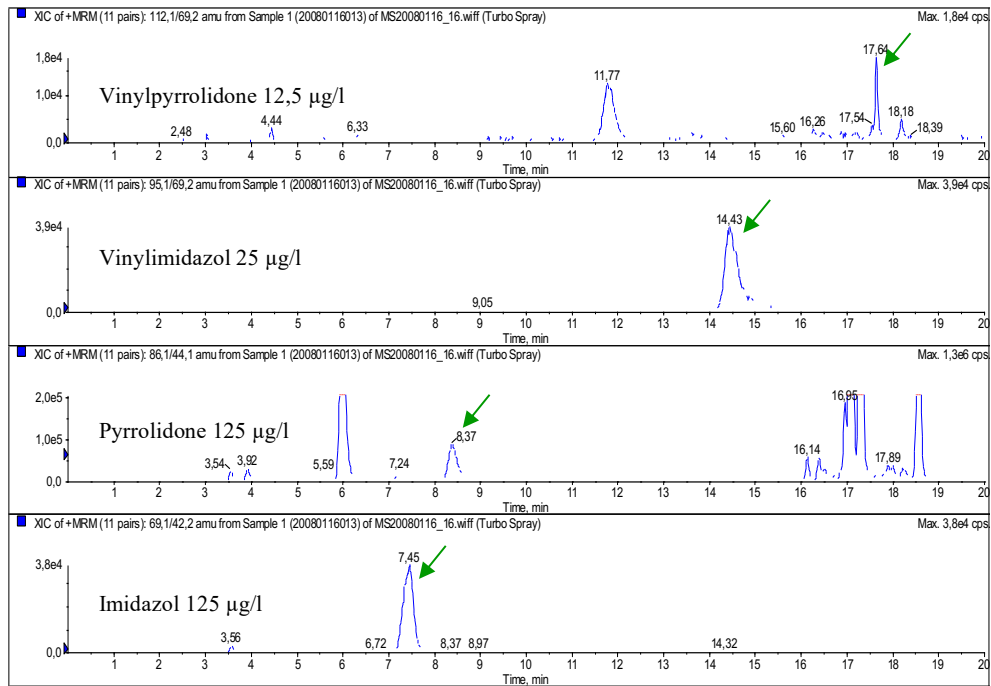

8.2 Quantification:

Mass transfers for quantification:

compound	mass transfer
Imidazole	69.1 → 42.2
Pyrrolidone	86.1 → 44.1
Vinylimidazole	95.1 → 69.2
Vinylpyrrolidone	112.1 → 69.2

Use the standard addition method for quantification.

8.3 Expression of results

Results should be expressed in µg/l for Imidazole, Pyrrolidone, Vinylimidazole and Vinylpyrrolidone with no decimals (e.g. 3 µg/l).

8.4 Limit of detection and limit of quantification

The limit of detection (LOD) and the limit of quantification (LOQ) depend on the individual measurement conditions of the chemical analysis and are to be determined by the user of the method.

The limit of detection (LOD) and the limit of quantification were estimated using the instrumentation and conditions mentioned as an example above (section 7) following the instructions in the resolution OENO 7-2000 (E-AS1-10-LIMDET) "*Estimation of the Detection and Quantification Limits of a Method of Analysis*". Following the "Logic Diagram for Decision-Making" in point 3 the "graph" approach should be applied following paragraph 4.2.1. For this purpose a window is drawn on the multiple reaction monitoring chromatogram, enclosing the range of a tenfold peak width at mid-height ($w_{1/2}$) either side at the retention time of an analyte peak in the relevant part of the chromatogram. Two parallel lines are then drawn which just enclose the maximum amplitude of the signal window. The separation between these two lines gives h_{max} , expressed in abundance units, which is multiplied by 3 for LOD, by 10 for LOQ, and finally converted into concentration units by implementing the individual response factor.

compound	limit of detection (LOD)	limit of quantification (LOQ)
Imidazole	5 µg/l	12 µg/l
Pyrrolidone	25 µg/l	83 µg/l
Vinylimidazole	2 µg/l	6 µg/l
Vinylpyrrolidone	2 µg/l	6 µg/l

9 Precision and trueness

As matrices three different wines (dry white wine, dry red wine and sweet red wine) and grape juice were used. Within-laboratory reproducibility, repeatability and recovery were calculated based on matrix calibration and three spikes (Imidazole: 40/60/80 µg/l; 2-Pyrrolidone: 40/60/80 µg/l; Vinylimidazole: 8/12/16 µg/l; Vinylpyrrolidone: 4/6/8 µg/l).

1.1 Imidazole

	fortification	mean of series	standard deviation	corresponding CV	Horwitz RSD %
within-laboratory reproducibility (SD_{wIR}):	40 µg/l	41	2	5 %	26
	60 µg/l	61	3	5 %	24
	80 µg/l	80	5	6 %	23
repeatability (SD_r):	40 µg/l	41	1	2 %	
	60 µg/l	61	2	3 %	
	80 µg/l	80	4	5 %	
recovery (WDF):	40 µg/l	102 %			
	60 µg/l	101 %			
	80 µg/l	101 %			
	0	101 %			

1.2 Pyrrolidone

	fortification	mean of series	standard deviation	corresponding CV	Horwitz RSD %
within-laboratory reproducibility (SD_{wIR}):	40 µg/l	42	9	22 %	26
	60 µg/l	60	9	15 %	24
	80 µg/l	81	9	11 %	23
repeatability (SD_r):	40 µg/l	42	5	12 %	
	60 µg/l	60	4	7 %	
	80 µg/l	81	8	9 %	
recovery (WDF):	40 µg/l	105 %			
	60 µg/l	100 %			
	80 µg/l	101 %			
	0	102 %			

1.3 Vinylimidazole

	fortification	mean of series	standard deviation	corresponding CV	Horwitz RSD %
within-laboratory reproducibility (SD_{wIR}):	8 µg/l	8	0	4 %	33
	12 µg/l	12	1	5 %	31
	16 µg/l	16	1	4 %	30
repeatability (SD_r):	8 µg/l	8	0	4 %	
	12 µg/l	12	0	3 %	
	16 µg/l	16	0	3 %	
recovery (WDF):	8 µg/l	101 %			
	12 µg/l	102 %			
	16 µg/l	102 %			
	0	102 %			

1.4 Vinylpyrrolidone

	fortification	mean of series	standard deviation	corresponding CV	Horwitz RSD %
within-laboratory reproducibility (SD_{wIR}):	4 µg/l	3	1	31 %	37
	6 µg/l	4	1	26 %	35
	8 µg/l	5	2	29 %	33
repeatability (SD_r):	4 µg/l	3	1	25 %	
	6 µg/l	4	1	22 %	
	8 µg/l	5	1	26 %	
recovery (WDF):	4 µg/l	66 %			
	6 µg/l	63 %			
	8 µg/l	66 %			
	0	65 %			

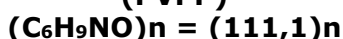
POLYVINYLPOLYPYRROLIDONE**POVIDONE****(PVPP)****INS N°: 1202**

AG 2/85-OEN;

OENO 2/88;

OENO 11/2002;

OENO 4/2007

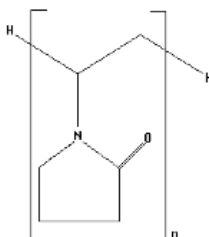
**1. OBJET, ORIGIN AND FIELD OF APPLICATION**

Insoluble polyvinylpolypyrrolidone is a polymer poly[1-(2-oxo-1-pyrrolidinylethylene)] reticulated to render it insoluble. It is made by polymerisation of N-vinyl-2-pyrrolidone in the presence of different catalysers (for example sodium hydroxide) or in the presence of N'-divinylimidazolidone.

PVPP fixes the polyphenols in wines; this adsorption depends on the rate of polymerisation. Its application rate is limited.

2. SYNONYMS

poly(1-ethenylpyrrolidin-2-one)

Crosprovidone (nomenclature of pharmacope)

Reticulated polyvidone

Reticulated homopolymer of 1-ethenyl-2-pyrrolidone

Reticulated insoluble polymer of N-vinyl-2-pyrrolidone

P.V.P. insoluble

Polyvinylpolypyrrolidone (PVPP).

3. LABELLING

The label must indicate that PVPP is for oenological usage, minimum guaranteed efficiency vis-à-vis safety test and storage conditions.

4. CHARACTERISTICS

Light powder, white and creamy white.

Insoluble in water and in organic solvents.

Insoluble in strong acid minerals and in alkaly.

5. TEST TRIALS

5.1 Loss through drying

Place 2 g of PVPP in a 70 mm diameter silica capsule; dry in an incubator at 100-105° C for 6 hours. Let cool in the desiccators. Weigh. Weight loss must be less than 5%.

It is also possible to carry this out more quickly by titration with the Karl-Fischer procedure (see annex).

Note: All limits set above refer to the dried product.

5.2 Ashes

Incinerate the residue left over in test trial 5.1 progressively without going over 600° C. (Ash mass should be less than 0.5%).

5.3 Preparation for test trial solution

After weighing the ashes, dissolve 1 ml of concentrated hydrochloric acid (R) and 10 ml of distilled water. Heat to activate the solution. Bring up to 20 ml with distilled water. 1 ml of this solution contains 0,10 g of PVPP mineral matter.

5.4 Heavy metals

10 ml of solution prepared according to point 5.3 is put in a test tube with 2 ml of a pH 3.5 (R) buffer solution and 1.2 ml of reactive thioacetamide (R). There should be no precipitation. If a brown colour appears, it should be inferior to the test sample as indicated in Chapter II (Heavy metal content, expressed in lead, must be less than 10 mg/kg).

5.5 Lead

Using the solution prepared idem, determine the lead, following the procedure in Chapter II or by atomic absorption spectrophotometer procedure. Lead content must be below 2 mg/kg.

5.6 Mercury

Determine the mercury, following the procedure in Chapter II. Mercury content must be below 1 mg/kg.

5.7 Zinc

Determine the zinc, following the procedure described in Chapter II. Zinc content must be below 5 mg/kg.

5.8 Arsenic

Determine the arsenic, following the procedure in Chapter II. Arsenic content must be below 3 mg/kg.

5.9 Cadmium

Determine the cadmium using the method described in Chapter II of the International oenological Codex by atomic absorption spectrophotometer procedure.

Cadmium content must be below 1 mg/kg.

5.10 Sulphates

Determine the sulphates, following the procedure in Chapter II. Sulphate content must be below 1 g/kg.

5.11 Determining total nitrogen

Introduce approximately 0.20 g of PVPP weighed precisely in a 300 ml flask with 15 ml concentrated sulphuric acid (R) and 2 g of mineralisation catalyst (R) and continue the operation as indicated in Chapter II. (Total nitrogen content must be between 11 and 12.8%).

5.12 Solubility in a water medium

Introduce 10 g of PVPP in a 200 ml flask containing 100 ml of distilled water. Mix and leave for 24 hours. Filter through a gauze screen with a porosity of 2.5 μm and then through a gauze screen with a porosity of 0.8 μm . The residue left from the evaporation of dried filtrate over 100°C hot water, must be less than 50 mg (solubility in water must be less than 0.5%).

5.13 Solubility in acid and alcohol.

Introduce 1 g of PVPP in a flask containing 500 ml of the following mixture

Acetic acid	3 g
Ethanol	10 ml
Water	100 ml

Let sit 24 hours. Filter through a gauze screen with a porosity of 2.5 μm and then through a gauze screen with a porosity of 0.8 μm . Concentrate the filtrate over 100°C hot water. Stop evaporation over a 100° C hot water in a 70 mm diameter previously weighed silica capsule. The residue left by dry evaporation must be less than 10 mg, taking into account the residue left by evaporation of 500 ml of a mixture of acetic- acid ethanol (solubility in acetic acid and alcohol medium must be less than 1%).

6. PVPP EFFICIENCY WITH REGARDS TO ADSORPTION OF POLYPHENOLIC COMPOUNDS**6.1 Salicylic acid essay***6.1.1 Reagents:*

- 0.1 M sodium hydroxide solution
- 0.1M salicylic acid solution (13.81 g salicylic acid are dissolved in 500 ml of methanol and diluted with 1l of water).

6.1.2 Operating mode:

- Weigh 2-3 grams of PVPP in a 250 ml conical flask and write down the MASS M at ± 0.001 g.
- Calculate the dry extract of the sample (solid weight percentage) as P in % to the nearest decimal.
- Add the 0.1M salicylic acid solution according to the following formula:

$$43. M \cdot P = \text{ml to be added}$$

- Close the flask and shake for 5 minutes.
- Pour the 25°C mixture on a filter over a Büchner funnel connected to a 250 ml tube; empty it until there is at least 50 ml of filtrate (the filtrate must be clear).
- Use a pipette take 50 ml of the filtrate and put it in a 250 ml conical flask.
- Determine the neutralisation point of phenolphthalein and write down the volume V_s with a 0.1M sodium hydroxide solution.
- Titrate 50 ml of the salicycal acid solution (sample test) in the same manner and write down the volume V_b .

6.1.3 Calculation:

$$\% \text{ activity} = \frac{V_b - V_s}{V_b} \cdot 100$$

The percentage of activity must be equal or greater to 30%.

6.2. Determining the adsorption capacity of oenocyanine (30% minimum)

6.2.1. Principle

A small amount of PVPP is put in contact with a oenocyanine solution for 5 minutes. Adsorption at 280 nm of treated oenocyanine solution is compared to a standard solution and a blank solution made up of only solvent. The decrease of adsorption to 280 nm is used as a relative measurement of PVPP capacity to adsorb oenocyanine.

6.2.2. Reagents

- oenocyanine (hydrate of)
- Ethanol (absolute)
- Distilled water.

6.2.3. Material

- Spectrophotometer, UV visible.
- Quartz cuvettes, 1 cm of optical path.
- Beakers, 150 ml.
- Graduated flask, 1 litre.
- Teflon stirring rods and magnetic mixer.
- Syringes.

- Filters for syringes, (0,45 µm porosity).

6.2.4. Methods

- Solution E. Dissolve 80 mg of oenocyanine hydrate in 50 ml of ethanol. Quantitatively transfer to a one litre graduated flask (with distilled water) and dilute to volume indicated with the distilled water. Label this solution E, and keep in an amber coloured tube. This is the standard solution.

- Solution R. Prepare the reference solution by diluting 50 ml of ethanol in 1 litre of distilled water. This is the reference solution.

- Weigh 3 volumes of, 50 mg ± 0,1 mg of samples in 150 ml beakers. Add the Teflon mixing rods and put under the magnetic mixer.

NOTE: The contact time between the sample and the solution is *critical*. In the following steps, the addition of the solution to the samples will be in increments in order to foresee exactly 5 minutes between the introduction of the solution and the filtration of each sample.

- Using a pipette, add 100 ml of sample solution E, to 2 of the solutions and add 100 ml of solution R to the third sample. Put the timer on, once the 100 ml has been added.

- Shake for 5 minutes ± 5 seconds.

- With the aid of syringe and a filter with pores measuring 0.45 µm in diameter, withdraw a part of the solution immediately and filter in a clean flask. The filtered solutions can be stored in a cool and dark place for maximum 1 hour before measuring UV absorbency.

- Set up the UV spectrophotometer in compliance with manufacturers' instructions in order to measure absorbency at 280 nm. Put the machine at zero on 280 nm and use the R solution as a blank.

- Measure the degree of absorbency of each filtered extract at 280 nm compared to solution R by using quartz cuvettes with 1 cm optical path.

6.2.5. Calculations

$$\text{Absorbency capacity} = \frac{A_o - (A_T - A_B) \times 100}{A_B}$$

Given that:

A_o = Solution E absorbency

A_T = Sample solution absorbency

A_B = Blank solution absorbency (PVPP without oenocyanine)

Calculate the average for the two sample solutions.

7. DETERMINING OF THE N-VINYL-2-PYRROLIDONE MONOMER IN PVPP WITH THE AID OF HIGH PERFORMANCE LIQUID CHROMATOGRAPHY WITH UV DETECTION.

7.1. Principle

The N-vinyl-2-pyrrolidone monomer is the extract PVP polymer with methanol. The methanol solution is analysed by HPLC by using C8 type deactivated reversed phase column. This quantification is carried out by UV detection at 235 nm. Soluble PVP is eliminated when entering the column by a back flush technique.

This method can be applied to samples of which the monomer concentration is between 0.4 and 100 mg/l. The content of N-vinyl-2-pyrrolidone in PVPP should not exceed 10 mg per kg.

7.2. Reagents

- Methanol, HPLC grade.
- water, micro filtered rest > 18 MΩ.
- N-vinyl-2-pyrrolidone

7.3. Equipment

7.3.1 Glassware

- Assembling HPLC to filter solvents; entirely in glass.
- Filters for mobile phases, nylon 0.45 μm.

- Graduated pipettes (10, 20 and 100 ml).
- Volumetric flasks (100 and 1000 ml).
- 7.5 ml polyethylene pipettes
- Spatulas used for the handling of powder grams.
- Small flasks with polyethylene stoppers.
- Filters with porosity 0.45 μm in glass microfibers.

7.3.2. Instruments

- Scale, which can measure to the nearest 0.1 mg.
- Magnetic mixer
- HPLC system with type C8 column and UV-Visible detector.

7.4. Procedure

7.4.1. Preparation of the mobile phase

- Using a pipette, introduce 200 ml of HPLC grade methanol in a 1000 ml flask. Dilute as needed, with HPLC grade water and mix.
- Filter/degasify the mobile phase and then transfer to the solvent reservoir to pump HPLC.

7.4.2. Preparation of reference solution

- VP 1000 mg/l reference solution
Weigh about 100 mg of N-vinyl-2-pyrrolidone to the nearest 0.1 mg in a 100 ml volumetric flask. Dilute the volume as needed with the mobile phase
- VP 100 mg/l reference solution
Dilute 10 ml of the solution at 1000 mg/l to the needed volume, with the mobile phase, in a 100 ml volumetric flask.
- VP 10 mg/l reference solution
Dilute 10 ml of the solution at 100 mg/l to the needed volume, with the mobile phase, in a 100 ml volumetric flask.
- VP 1 mg/l reference solution
Dilute 10 ml of the solution at 10 mg/l to the needed volume, with the mobile phase, in a 100 ml volumetric flask.

7.4.3. Preparation of the sample

- In a small flask, weigh about 2.0 g of PVPP \pm 0.1 mg.
- Using a pipette, introduce 20 ml of HPLC grade methanol in the flask containing the sample.
- Close the flask vacuum tight and put it under an automatic mixer. Extract for 1 hour at a speed of 130 rotations per minute.

- After one hour, remove the flask from the mixer. Filter the supernatant with a filter with a porosity of 0.45 µm in glass micro fibres.

7.4.4. Analysis by HPLC

- Install the HPLC equipment in compliance with the manufacturers' instructions and balance the column and the detector with the mobile phase for at least one hour before analysing the reference test specimen and the samples.

HPLC conditions (as an example)

Vol. injection	20 micro litres
Solvent flow	1 ml/minute
Detection	235 nm
Duration	10 minutes for reference solutions without back flushing (60 minutes for samples with back flushing of columns) of which 10 minutes for back flushing and 50 minutes for the reconditioning of the column.

- Inject a reference specimen of 10 mg/l de N-vinyl-2-pyrrolidone (absolute concentration) three times every 6 to 10 samples to control the performance of the system.

7.4.5. Calculations

$$\text{mg/l of VP} = \frac{20 \times (\text{peak surface area of the sample}) \times (\text{response factor})}{\text{sample in grams}}$$

$$\text{with responsivity} = \frac{(\text{concentration of reference solution in mg/l})}{(\text{peak surface area of the reference solution})}$$

Comment

- Detection limit and minimum quantifiable quantity
Detection limit (signal/noise = 3 for PVPP sample with a content of 0.27 mg/l in N-vinyl-2-pyrrolidone) is ~ 0.10 mg/l with a minimum quantifiable (signal/noise = 10) of 0.33 mg/l.

- Recovery

During a laboratory test, the N-vinyl-2-pyrrolidone, overloaded with PVPP with 1.10 and 100 mg/l of VP, was respectively recovered at 108%, 99.0% and 102%.

- Retention time

The average length of peak retention of N-vinyl-2-pyrrolidone (at a rate of 10 mg/l) is 6.34 ± 0.08 minutes, for a column system + 13 cm long precolumn.

- Interferences

The appropriate duration for back flushing will be set for each system, otherwise a rigorous blocking of the column will take place.

8. DETERMINING THE FREE N,N'- DIVINYLMIDAZOLIDONE IN THE PVPP BY GAS CHROMATOGRAPHY.

This must be determined when the PVPP preparation technique N,N'-**divinylimidazolidone**.

the free N,N'-**divinylimidazolidone** in PVPP must not exceed 2 mg per kg.

8.1. Principle

Measuring by gas chromatography on a capillary column of free N,N'-divinylimidazolidone in a solvent (acetone) from non-soluble PVPP. Detection limit is 1 mg/kg.

8.2. Internal test specimen solution:

Dissolve 100 mg \pm 0.1 mg, of heptanoic acid in 500 ml of acetone.

8.3. Preparation of the sample

Weigh 2 to 2.5 g \pm 0.2 mg of polymer and pour into a 50 ml conical flask. Using a pipette, add 5 ml of internal standard solution, then 20 ml of acetone. Shake the mixture for 4 hours. Leave for 15 hours to stabilize and analyse the supernatant by gas chromatography.

8.4. Calibration solution

Weigh 25 mg \pm 0.2 mg of N,N'- divinylimidazolidone (The analytical standard can be obtained from specialized

laboratories, actually : BASF, D-67056 Ludwigshafen) and pour into a volumetric flask; add acetone up to 100 ml. Using a pipette, transfer 2.0 ml of this solution in a 50 ml volumetric flask and add acetone up to 50ml. Transfer 2 ml of this solution to a 25 ml volumetric flask, add 5 ml of internal standard solution (see above) and adjust the volume with acetone.

8.5. Gas chromatography conditions (as an example):

Column (fused silica) capillary (cross linked carbowax - 20 M), length 30 m, innerdiameter 0.25 mm, film thickness 0.5 µm.

Programmed column temperature	140°C to 240°C, 4°C/ minute.
Injector	split injector, 220°C. Flow rate 30 ml/min.
Detector	Thermionic detector (optimised in compliance with manufacturer's' instructions), 250°C.
Carrier gas	Helium, 1 bar (suppression).
Volume injected	1 µl of sample floating to the up solution or reference test sample solution.

8.6. Procedure

Validation of response factor for specific conditions of analysis is possible thanks to repeated injections of calibration solutions. Analyse the sample. The N,N'-divinylimidazolidone content in non-soluble PVPP must not exceed 0.1%.

8.7. Calculation of response factor:

$$f = \frac{W_d \times A_{se}}{W_{se} \times A_d}$$

W_d - quantity of N,N'-divinylimidazolidone used (mg)

W_{se} - quantity of internal standard used (mg)

A_{se} - peak area of standard solution

A_d - peak area of N,N'-divinylimidazolidone .

8.8. Calculation of N,N'-divinylimidazolidone content:

$$C_D = \frac{1000f.A_d.W_{se}}{A_{se}.W_s} \text{ (mg/kg)}$$

C_d = concentration of N,N'-divinylimidazolidone (mg/kg)

f = response factor

A_d = peak area of N,N'-divinylimidazolidone

W_{se} = quantity of internal standard added to the sample (mg)

A_{se} = peak area of internal standard solution

W_s = quantity of sample used (g)

9. STORING CONDITIONS

PVPP must be kept in a ventilated place in vacuum packed containers away from volatile elements that is might adsorb.

ANNEX

Karl-Fischer procedure**1.FIELD OF APPLICATION**

This method is used to determine the water content in a transverse link PVP. Vinylpyrrolidone residue does not interfere with the usual rate present (0.1%). This method is able to detect water with concentrations above 0.05% (m/m).

2.PRINCIPLE

The sample is dissolved in anhydrous methanol and titrated using a Karl-Fischer reagent (KF) without pyridine. Water reacts to the titrating solution in the following way:



The final point (excess I_2) is determined by controlling the change in current between two micro-electrodes and the polarized platinum. The typical KF titration is completely automated and directly produces the calculated water levels.

3.REAGENTS

1. Karl Fischer reagent without pyridine (example by AQUASTAR AXI698A or the equivalent)
2. anhydrous methanol
3. Silica gel with humidity indicator for desiccation of the tube in the cell.
4. The analytic al standard can be obtained from specialized laboratories (actually : BASF, D-67056 Ludwigshafen)

4.APPARATUS

Karl Fischer Titrimeter

5. METHOD

1. Fill the titration recipient with 50 ml of anhydrous methanol or an amount sufficient to cover the electrodes. Fill the desiccation tubes above the cell of the fresh silica gel.
2. Calibrate the titration solution by using distilled water as a specimen.

Record the weight of the sample and the tare, as indicated in the instrument instruction booklet.

The apparatus will automatically calculate the average titer and will store the figure for three testings. (the assay solution H₂O/ml in grams). If an analytical balance is available for reporting the sample weight, follow instructions in the manual.

3. Add 0.075 g to 0.150 g of sample (to the nearest 0.1 mg) in a reaction recipient and mix for 2 minutes. Report the weight of the sample and the tare. The apparatus will measure the assay and automatically determine the % water content.
4. Carry out analysis in duplicate

6. CALCULATION

1. Titrate the assay solution KF, T

$$\frac{\text{water specimen in mg}}{\text{assay solution used in ml}}$$

2. % of water in the sample

$$\frac{0.1 TV}{S}$$

Where V = ml of assay solution used
S = weight of samples in grams

7. INTERFERENCES

High concentrations of vinylpyrrolidone (>0.5%) residues react with iodine and produce very imprecise results.

(A 1% vinylpyrrolidone residual rate corresponds to a H₂O rate taken from 0.16% (m/m).

An excess base in the sample risks changing the solution pH and can produce low level results. Samples with pH levels >8 should be buffered with 5 g benzoic acid for 50 ml.

Potassium polyaspartate

Chemical name: Homopolymer of potassium L-aspartate or potassium polyaspartate

Chemical formula: $[C_4H_5NO_3K]_n$

Topological formula:

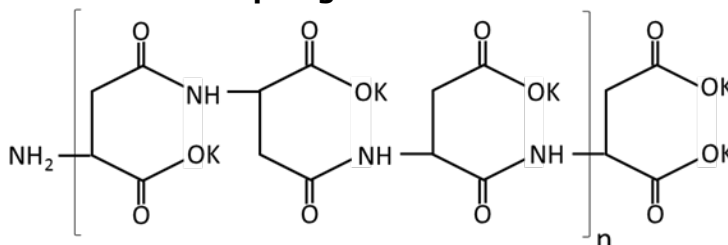

where $n \approx 30$

CAS No.: 64723-18 -8

OIV-OENO 572-2017;

OIV-OENO 645-2020

1. OBJECT, ORIGIN AND SCOPE OF APPLICATION

Oenological potassium polyaspartate is prepared exclusively from L-aspartic acid. The L-aspartic acid monomer used in the process is produced by fermentation. A thermal process converts the L-aspartic acid monomer into polysuccinimide, an insoluble compound. Polysuccinimide is then treated with potassium hydroxide under controlled conditions to obtain potassium polyaspartate. The potassium polyaspartate inhibits tartaric precipitation thanks to a 'colloid protector' effect. Potassium polyaspartate is effective for the tartaric stabilisation of wines.

2. SYNONYMS

Potassium polyaspartate, A-5D K/SD; A-5D K SD; A-5DK/SD; A-5DK; KPA.

3. LABELLING

The following indications should appear on the packaging labelling:

- the name and sales denomination,
- the statement 'Product for oenological use, limited use',
- any additives,

- instructions for use,
- the batch number and potassium polyaspartate content (purity) as well as the expiry date and storage conditions (temperature, humidity and aeration),
- the name or company name and address of the manufacturer, packager or supplier,
- the net quantity,
- the indication that the aspartic acid is sourced from genetically-modified organisms and the modified characteristic where relevant.

4. CHARACTERISATION

4.1 Description

Light-brown, odourless powder containing 90% dry matter. It is entirely soluble in water (> 1000 g/L) yet insoluble in organic solvents (< 5 g/L), with a shelf life of 4 years at room temperature.

4.2 Chemical formula

Potassium polyaspartate is a polymer composed of aspartic acid units, with the following general formula: $[C_4H_5NO_3K]_n$, where n corresponds to the average degree of polymerisation ($n \approx 30$).

4.3 Degree of substitution

The degree of substitution of the potassium salt is at least 91.5% (in terms of anhydrous matter), in order to guarantee optimal solubility. Assess the degree of substitution using the method described in Annex 1.

4.4 Molecular mass

Its average molecular mass, determined by gel permeation chromatography, is 5000 g/mol, which corresponds to the optimum efficiency of the product.

4.5 Composition

The purity of the product is verified by assaying the aspartic acid after total hydrolysis of the polymer and by comparing this value with the theoretical content of the monomer in the potassium

polyaspartate according to its molecular formula. Refer to Annex 2 for the method description.

The content of anhydrous potassium polyaspartate matter should be at least 98%.

5. TRIALS

5.1 Free aspartic acid content in potassium polyaspartate

The free aspartic acid content should be $\leq 2.0\%$.

Carry out the determination according to the method described in Annex 3.

5.2 Humidity – Loss due to dehydration

Determine the loss in mass of a gram of dry product kept in an oven for 12-24 hours at 105 ± 2 °C. The mass should be constant and the loss in mass should be less than 10%.

5.3 Metal content

Before determining the metals, mineralise the sample by means of acid digestion (HNO_3 , H_2O_2 and HCl). Conduct the mineralisation in a microwave oven. The sample should not be crushed or dehydrated before mineralisation.

The reagents used for mineralisation are as follows: HNO_3 (65%) (Suprapur or similar), HCl (37%) (Suprapur or similar) and H_2O_2 (35%).

Introduce the polyaspartate sample (between 0.5 and 2 g) into a 100-mL calibrated flask before adding 25 mL HNO_3 , 2 mL HCl and 3 mL H_2O_2 . At this stage, subject the mixture to digestion in a microwave oven with a maximum power of 1200 W: 60% power for 1 min, 30% for 10 min, 15% for 3 min and 40% for 15 min. Subsequently, make the calibrated flask up to volume with double-distilled water. The determination of the metals is practised on the solution thus obtained.

5.3.1. Iron

Determine the iron according to the method described in Chapter II of the *International Oenological Codex*. The iron content should be below 10 mg/kg.

5.3.2. Arsenic

Determine the arsenic according to the method described in Chapter II of the *International Oenological Codex*. The arsenic content should be below 3 mg/kg.

5.3.3. Lead

Determine the lead according to the method described in Chapter II of the *International Oenological Codex*. The lead content should be below 2 mg/kg.

5.3.4. Mercury

Determine the mercury according to the method described in Chapter II of the *International Oenological Codex*. The mercury content should be below 1 mg/kg.

5.3.5. Cadmium

Determine the cadmium according to the method described in Chapter II of the *International Oenological Codex*. The cadmium content should be below 1 mg/kg.

ANNEX 1**1. Determination of the degree of substitution****1.1 Principle**

The degree of substitution of commercial potassium polyaspartate is determined by the analysis of the potassium content using the ICP-OES method.

The determination of potassium is conducted using a calibration curve obtained by injecting five different concentrations of a reference standard solution.

To calculate the degree of substitution, the potassium concentration measured is compared to the theoretical content at 100% substitution.

1.2 Equipment

1.2.1 100-mL Volumetric flasks (class A)

1.2.2 Cyclonic atomisation chamber, standard quartz torch

1.2.3 Ultrasonic bath

1.2.4 Membrane filtration system with 0.45- μ m porosity

1.3 Reagents

1.3.1 65% Nitric acid (HNO₃)

1.3.2 10 000 mg/L Potassium (K) standard solution (potassium ICP/DCP standard solution with 10 000 μ g/mL 5% HNO₃)

1.3.3 Double-distilled water with superior resistivity of 10 M Ω .cm

1.3.4 Aqueous solution acidified with 0.5% HNO₃ (calibration blank), to be used as a diluent for the preparation of the calibration solutions

1.3.5 Calibration solutions prepared by dilution of the stock solution (point 1.3.2); the reference values are indicated below:

	STD 1	STD 2	STD 3	STD 4	STD 5
Potassium (mg/L)	200	400	600	1000	2000

1.4 Procedure

The preparation to be analysed (KPA) is dissolved in double-distilled water.

1.4.1 5000 mg/L KPA solution (a): weigh around 500 g (note the exact weight) directly into a 100-mL calibrated flask, make up to volume with double-distilled water (1.3.3) and stir in an ultrasonic bath (1.2.3) for at least 10 minutes. Filter using membranes with 0.45 µm porosity.

1.4.2 Prepare the five-point calibration curve with the standard solutions as indicated in point 1.3.5.

The results should be calculated from the average of three measurements.

If the concentration lies outside the calibration curve, the sample should be diluted so that its concentration falls within the calibration curve.

To calculate the degree of substitution, compare the potassium concentration measured to the theoretical content established at 100% substitution (see point 1.5).

1.5 Calculations

The potassium content is calculated by the processor of the acquisition software. The calculation to be conducted is as follows:

$$A = A' \times n \quad (a)$$

where:

A: concentration of sample in mg/L

A': concentration of diluted sample in mg/L

n: dilution factor

The percentage of potassium in the KPA sample, expressed in dry weight, is calculated using formula (b):

$$\%K_{(dry\ weight)} = A \frac{100}{w} \frac{100}{(100 - h\%)} \quad (b)$$

where:

A: result of equation (a)

w: potassium polyaspartate in mg/L

h%: humidity of the sample, as a percentage

The degree of substitution (DS) is calculated using equation (c):

$$\%DS_K = \frac{\%K_{(\text{dry weight})}}{\frac{MA_K}{MM_{KPA\text{monomer}}}} \cdot 100 \quad (\text{c})$$

where:

MA_K: atomic mass of potassium

MM_{KPAmonomer}: calculated molecular mass of the polyaspartate monomer

ANNEX 2

2. Determination of the purity of potassium polyaspartate

2.1 PRINCIPLE

Analysis by HPLC-FLD of the free aspartic acid content after acid hydrolysis.

The principle consists of determining the free aspartic acid by HPLC after acid hydrolysis of the KPA. This acid hydrolysis takes place under conditions allowing for the complete depolymerisation of the KPA:

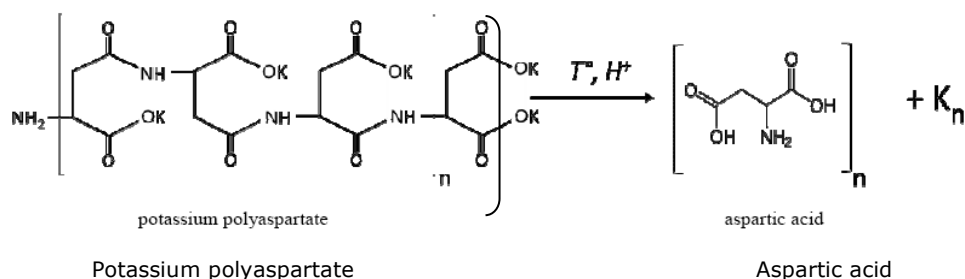

2.2 EQUIPMENT / APPARATUS

- 2.2.1 Hot plate for acid hydrolysis
- 2.2.2 4-mL Tinted-glass vials with screw cap
- 2.2.3 0.1 mg Precision weighing balance
- 2.2.4 Calibrated flasks
- 2.2.5 HPLC system including a quaternary pump, an automatic sampler, a thermostat and a fluorometric detector (FLD)
- 2.2.6 C18 column (e.g. Synchronis aQ C18, 4.6 x 250 mm; 5 µm [Thermo])
- 2.2.7 Filtration system with membranes of 0.2 µm porosity

2.3 REAGENTS AND SAMPLE PREPARATION

For acid hydrolysis

- 2.3.1 Potassium metabisulphite solution (Na₂S₂O₂) (CAS No. 16731-55-8) at a concentration of 10 g/L

2.3.2 6 M Hydrochloric acid (HCl)

2.3.3 5 M Sodium hydroxide (NaOH)

2.3.4 Double-distilled water with superior resistivity of 10 mΩ.cm

2.3.5 Potassium polyaspartate

For sample preparation

2.3.6 Aminocaproic acid (C₆H₁₃NO₂, CAS No.: 60-32-2)

2.4 PROCEDURE

The procedure comprises three steps:

- hot acid hydrolysis of the potassium polyaspartate sample,
- preparation of the samples for analysis by HPLC-FLD of the standard solutions that will determine the aspartic acid concentration,
- analysis of the free aspartic acid after hydrolysis by HPLC (see Annex 3).

2.4.1 Phase 1: acid hydrolysis

2.4.1.1 Transfer into a 4-mL vial (2.2.2):

0.2 mL 10 g/L sodium metabisulphite solution (2.3.1),

0.5 g potassium polyaspartate weighed to the nearest mg,

2 mL 6 N HCl (2.3.2).

2.4.1.2 Heat to 108 ± 2 °C for 72 hours (2.2.1).

2.4.1.3 Transfer to a 10-mL calibrated flask, add 2.4 mL 5 M NaOH (2.3.3) and make up to volume with double-distilled water (2.3.4).

2.4.2 Phase 2: preparation of the sample for HPLC analysis

2.4.2.1 Microfilter 5 mL of medium (2.4.1.3) at 0.20 µm (2.2.7) in a 20-mL calibrated flask.

2.4.2.2 Add 0.2 mL internal standard (aminocaproic acid) (2.3.6).

2.4.2.3 Make up to volume with double-distilled water.

2.4.3 Phase 3: Analysis of samples by HPLC (see Annex 3)

CALCULATIONS

The polyaspartate concentration (KPA) is calculated as follows:

KPA (mg/L) = (hydrolysed aspartic acid – free aspartic acid before hydrolysis) × f_{KPA}

where $f_{KPA} = 1.15$, which is the conversion factor of KPA into aspartic acid, calculated based on the ratio between the molecular mass of the KPA monomer (average MM of KPA A5DK SD monomers = 154) and the molecular mass of aspartic acid (133.1), as per the equation:

$$f_{KPA} = \frac{MM_{KPA_monomer}}{MM_{aspartic_acid}} = 1.15$$

where the free aspartic acid is determined according to Annex 3.

ANNEX 3**3. Determination of free aspartic acid****3.1 PRINCIPLE**

The determination of aspartic acid in potassium polyaspartate as it was produced is carried out by HPLC coupled with fluorometric detection (FLD), after derivation of aspartic acid with ortho-phthalaldehyde (OPA). Potassium is determined using a calibration curve obtained by injecting the reference standard solutions.

3.2 EQUIPMENT / APPARATUS

3.2.1 Calibrated flasks

3.2.2 HPLC system including a quaternary pump, an automatic sampler, a thermostat and a fluorometric detector (FLD)

3.2.3 C18 column, e.g. Synchronis aQ C18, 4.6 x 250 mm; 5 µm

3.3 REAGENTS

3.3.1 Aspartic acid (D,L-aspartic acid, $C_4H_7NO_4 \geq 99\%$, CAS No.: 617-45-8)

3.3.2 Solution 1: 8000 mg/L aspartic acid in double-distilled water

3.3.3 Solution 2: 200 mg/L aspartic acid in double-distilled water

3.3.4 Aminocaproic acid ($C_6H_{13}NO_2$, CAS No.: 60-32-2)

3.3.5 1000-mg/L aminocaproic acid stock solution in double-distilled water

3.3.6 Calibration solutions prepared by dilution of solution 1 (point 3.3.2) and solution 2 (3.3.3), whose reference values are indicated below:

	STD 1	STD 2	STD 3	STD 4	STD 5	STD 6
mL H ₂ O	18.8	19.0	15.0	19.750	19.375	18.750
mL Solution 1	-	-	-	0.250	0.625	1.250
mL Solution 2	0.2	1.0	5.0	-	-	-
Aspartic acid (mg/L)	2	10	50	100	250	500

3.3.7 Methanol for HPLC

3.3.8 Tetrahydrofuran for HPLC

3.3.9 Anhydrous sodium acetate (CAS No. 127-09-3)

3.3.10 Acetonitrile (CH₃CN) for HPLC

3.3.11 Sodium tetraborate decahydrate
(Na₂B₄O₇·10H₂O, CAS No. 1303-96-4)

3.3.12 O-phthalaldehyde (OPA): (C₈H₆O₂ ≥ 99%,
CAS No.: 643-79-8)

3.3.13 Mercaptoethanol: (C₈H₆OS ≥ 99%, CAS No.:
60-24-2)

3.3.14 Double-distilled water with superior
resistivity of 10 MΩ.cm

3.3.15 Derivation solution: in a 10-mL calibrated flask, introduce
100 mg OPA, 200 mL mercaptoethanol and 1 mL methanol, then
make up to volume with a pH 10.5 buffer solution of 0.1 M
sodium tetraborate decahydrate.

The solution should be prepared just before use since it degrades over
the day following its preparation.

3.4 MOBILE PHASES

3.4.1 [Channel A]: ultra-pure water

3.4.2 [Channel B]: 0.05 M sodium acetate
buffer/tetrahydrofuran (96:4; v/v)

3.4.3 [Channel C]: methanol

3.4.4 Channel D]: acetonitrile

3.5 PROCEDURE

The method consists of a reaction constituting the derivation of aspartic acid with the O-phthalaldehyde (OPA); the recovery rate for this process is 100%.

The instrumental parameters are as follows:

- temperature of the column: 40 °C,
- wavelength (λ): FLD Ex 340 nm, Em 450 nm,
- the separation is carried out in gradient mode (see point 3.4, Mobile phases):

Time (min)	% B	% C	% D	Flow (mL/min)
0.00	100.0	0.0	0.0	1.1
3.00	100.0	0.0	0.0	1.1
15.00	50.0	25.0	25.0	1.1
17.00	84.0	8.0	8.0	1.1
18.00	100.0	0.0	0.0	1.1
Run time: 21 min + 2 min downtime				

3.5.1 Prepare the calibration solutions by mixing 5.0 mL of the standard solution (3.3.6) and 0.2 mL of the internal standard solution (3.3.5) in a 20-mL calibrated flask, then make up to volume with double-distilled water and stir.

3.5.2 Dilute 5.0 μ L of the sample (Annex 2, point 2.4.2) with 20 μ L methanol, then derive with 0.5 μ L OPA. Mix 10.0 μ L of the thus-obtained solution 10 times in the injector, then inject after 0.5 min.

3.5.3 If the results exceed the upper limit of the calibration curve, dilute the sample and repeat the analytical procedure.

3.6 CALCULATIONS

The concentration of aspartic acid in the sample, expressed in mg/L, is obtained by applying the following formula:

$$Y = A \cdot f \cdot d$$

where:

Y: concentration of aspartic acid in the sample, in mg/L

A: peak area of the chromatogram
f: response factor of the chromatogram peak
d: dilution factor

ANNEX 4

Method of determination of the mean molecular mass of potassium polyaspartate

1. Introduction

The effectiveness of potassium polyaspartate used in tartaric stabilisation depends on the parameter of mean molecular mass, therefore it is necessary to have a method to determine the latter.

2. Objective

Parameter to be determined: mean molecular mass, expressed in g/mol.

3. Definitions

GPC/SEC: gel permeation chromatography.

4. Principle

The determination of the mean molecular mass requires the use of gel permeation chromatography (GPC/SEC). This is a type of molecular exclusion chromatography used to separate molecules according to their size.

5. Reagents and equipment

- 5.1 Double-distilled water with resistivity of $> 10 \text{ M}\Omega\cdot\text{cm}$ at 25°C
- 5.2 Anhydrous sodium sulphate (Na_2SO_4) with a purity of $\geq 99\%$ (CAS No. 7757-82-6)
- 5.3 Anhydrous monobasic potassium phosphate (KH_2PO_4) with a purity of $\geq 99\%$ (CAS No. 7787-77-0)
- 5.4 Sodium azide with a purity of $\geq 99\%$ (CAS No. 26628-22-8). In using sodium azide, preventative measures should be taken to mitigate the risks of toxicity and instability (explosion)
- 5.5 Sodium polyacrylate salts with molecular masses of between 1000 and 1250 g/mol (CAS No. 9003-04-7)
- 5.6 L-aspartic acid with a purity of $\geq 98\%$ (CAS No. 56-84-8)
- 5.7 Potassium polyaspartate with a purity of $\geq 98\%$ (CAS No. 64723-18-8)

6. Apparatus

- 6.1 Filtration system with porosity of 0.22 μm
- 6.2 GPC column adapted to molecular mass intervals of between 500 and 10,000 g/mol
- 6.3 UV detector

7. Preparation of the sample

Prepare a volume of around 15 mL of 0.1% potassium polyaspartate solution (5.7) in the mobile phase (8.1) and filter it on a 0.22 μm filter (6.1). The polyaspartate solution in the buffer becomes unstable after 3 hours. Fresh solutions should therefore be prepared before each injection.

7.1 Calibration

Prepare 0.1% solutions for each standard (5.5 and 5.6) in the mobile phase (8.1).

Inject the standards to be used in order of decreasing molecular mass.

The calibration curve is obtained by representing the retention time (variable x) on a graph as a function of the logarithm of the mean molecular mass of the standards (5.5) (variable y) ($r^2 \geq 0.99$).

8. Procedure**8.1 Preparation of the mobile phase**

The mobile phase is a buffer solution composed of 0.1 M Na_2SO_4 (14.2 g/L) (5.2), 0.01 M KH_2PO_4 (1.36 g/L) (5.3) and 20 mg/L sodium azide (5.4) in double-distilled water (5.1) filtered using a 0.22- μm filter. The buffer solution should be used within 4 days of preparation.

8.2 Chromatography conditions

- Flow rate: 0.7 mL/min
- Column: Ultrahydrogel™ Linear or similar, dimensions: 7.8 x 300 mm, filled with particles of an average diameter of 6 μm
- Column temperature: 50 °C
- Run time: 40 min
- Injection volume: 200 μL
- UV detector: wavelength of 220 nm

9. Calculations

Compare the chromatographic profile corresponding to the sample with that of the standards (5.5). Calculate the molecular mass of polyaspartate, expressed in g/mol, according to the retention time of the sample and the calibration curve.

POTASSIUM ALGINATE

Kalii Alginas

OENO 33/2000;

OIV/OENO 410/2010

1. OBJECTIVE, ORIGIN AND SCOPE OF APPLICATION

This is a potassium salt of alginic acid extracted from various types of pheophyceae algae, in particular laminaria, by means of alkaline digestion and purification.

It is a clarifying agent used during the second fermentation in the bottle for sparkling wines.

2. LABELING

The label should indicate the product's purity and safety and storage conditions.

3. PROPERTIES

Potassium alginate is a white or yellowish powder which is nearly odorless and itasteless and which is composed of fiber fragments, when seen under a microscope.

With water, it produces a viscous solution. The pH of this solution is typically between 6 and 8. It is soluble in strong alcohol and in most organic solvents.

A gelatinous calcium alginate precipitate forms if a 0.50 ml of 20 pp 100 calcium chloride solution (R) is added to 5 ml of an aqueous 1 pp 100 potassium alginate (m/v) solution.

A gelatinous alginic acid precipitate form if 1 ml of sulfuric acid diluted to 10 pp 100 (R) is added to 10 ml of an aqueous 1 pp 100 potassium alginate (m/v) solution.

4. TESTS

4.1. Starch

Add 5 ml of iodinated water (R) to 5 ml of aqueous 1 pp 100 potassium alginate (m/v) solution. No blue coloration should develop.

4.2. Gelatin

Add 1 ml of 2 pp 100 hot tannin (R) to 10 ml of aqueous 1 pp 100 potassium alginate (m/v) solution. No precipitate should form.

4.3. Desiccation loss

Desiccation loss determined up to constant weight of a precisely-weighed sample of approximately 1 g. The weight loss of the potassium alginate at 100-105 °C should not be greater than 15 pp 100.

All limits indicated below are for dry product.

4.4. Sulfur Ash

The sulfur ash content using the method indicated in the Annex is determined by analyzing the residue from the previous test (4.3). The concentration of sulfur ash in the potassium alginate sulfuric ashes should not exceed 40 pp 100.

4.5. Preparing the Solution for Tests

In a silica dish, calcine a sample whose weight corresponds to 2.5 g of dry product, without exceeding 550 °C. Take up the residue with 10 ml of water and 2 ml of concentrated nitric acid (R). Decant in a 50 ml volumetric flask. Add 2 ml of concentrated ammonium hydroxide (R). Top off to 50 ml with distilled water. Filter.

4.6. Sulfates

To 2 ml of the solution prepared for tests under paragraph 4.5, add 2 ml of dilute hydrochloric acid (R) and top off to 20 ml. Add 2 ml of 10 pp 100 barium chloride solution (R). The mixture should be clear ; or else, the opalescence observed after 15 minutes should be less intense than that observed in a control prepared as indicated in the Annex. (Sulfate content expressed in terms of sulfuric acid should be less than 1 g/kg).

4.7. Chlorides

Add 5 ml of dilute 10 pp 100 nitric acid (R), 14 ml of distilled water and 0.5 ml of 5 pp 100 silver nitrate (R) to 1 ml of the test solution (Par. 4.5). Any opalescence that appears should be less intense than that of a control prepared as indicated in the Annex. (Chloride content, expressed in terms of hydrochloric acid, should be less than 1 g/kg).

4.8. Iron

Add 8 ml of water, 1 ml of concentrated hydrochloric acid (R), 1 drop of 1 pp 100 potassium permanganate solution (R) and 2 ml of 5 pp 100 potassium thiocyanate solution (R) to 2 ml of the test solution prepared under paragraph 4.5.

Any red coloration that appears should be less intense than that of a control prepared with 3 ml of iron (III) solution in a concentration of 0.010 g iron per liter (R), 7 ml of water and the same quantities of concentrated hydrochloric acid (R) and 5 pp 100 potassium thiocyanate solution (R). (Iron content should be less than 300 mg/kg).

Iron content can also be determined by atomic absorption spectrometry, by implementing the technique described in the compendium.

4.9. Cadmium

Using the technique described in the annex, determine cadmium content in the test solution (Par. 4.5). Content should be less than 1 mg/kg.

4.10. Lead

Using the technique described in the Compendium, determine lead content in the test solution (Par. 4.5). Content should be less than 5 mg/kg.

4.11. Mercury

Using the technique described in the annex, determine mercury content in the test solution (Par. 4.5). Content should be less than 1 mg/kg.

4.12. Arsenic

Using the technique described in the annex, determine arsenic content in the test solution (Par. 4.5). Content should be less than 3 mg/kg.

4.13. Sodium

Using flame photometry, determine sodium content in the test solution (Par. 4.5). Sodium content should be less than 1 pp 100.

5. STORAGE

Potassium alginate should be stored in hermetically sealed packages.

CALCIUM (ALGINATE)
SIN N°: 402

1. OBJECT, ORIGIN AND SCOPE OF APPLICATION

Calcium alginate is obtained from a 1 % aqueous solution of potassium alginate or alginic acid placed in contact with a 20 % aqueous solution of calcium chloride. Beads of calcium alginate can be produced by dropping droplets of potassium alginate solution into a calcium chloride solution.

Beads of calcium alginate, dry or wet, can contain yeasts or lactic bacteria, dry or wet. They are used for foam forming purposes in the bottle for sparkling wine or to restart alcoholic fermentation in still wines or to start the malolactic fermentation.

These beads can be coated with a double layer of potassium or calcium alginate or with colloidal silica to prevent the precipitation of the yeasts or bacteria incorporated into the beads.

2. LABELLING

The label should indicate the product's purity and the safety and storage conditions for calcium alginate, the yeasts or bacteria incorporated into the beads, the expiration date and the lot number.

3. CHARACTERISTICS

Calcium alginate is a translucent gel, which is insoluble in water and wine. It only dissolves in a sodium metaphosphate solution.

An alginic acid precipitate is also produced if 1 ml of sulfuric acid diluted to 10 % (R) is added to 10 ml of an aqueous 1 % (m/v) suspension of calcium alginate.

POTASSIUM ANHYDROUS SULFITE**Potassium pyrosulfite****Potassium disulfite****Potassium metabisulfite*****Kalii metabisulfis*** **$K_2S_2O_5 = 222.3$** **SIN No. 224****OENO 34/2000****1. OBJECTIVE, ORIGIN AND SCOPE OF APPLICATION**

Potassium anhydrous sulfite, commonly called potassium metabisulfite, is used because of the sulfur dioxide it makes available. Potassium metabisulfite, which is sold in powdered form, contains 52-55% by weight SO_2 .

There are regulatory limits restricting the sulfur dioxide content of wines.

2. LABELING

The label should indicate the product's purity as well as its safety and storage conditions.

3. CENTESIMAL COMPOSITION

Sulfur dioxide	57.63
Potassium	35.17

4. SOLUBILITY

Water at 20 °C	454.5 g/l
Alcohol, 95% by vol.	insoluble

5. IDENTIFYING PROPERTIES

5.1. 5 ml of aqueous 10 pp 100 (m/v) solution treated with 5 ml of 1/10 diluted sulfuric acid (R) releases sulfur dioxide and reduces iodine and potassium permanganate.

5.2. The 10 pp 100 (m/v) aqueous solution is acidic as indicated by methyl red (R) of (pH approximately 5).

5.3. The 1 pp 100 (m/v) aqueous solution produces potassium-based reactions.

6. TESTS

6.1. Preparing the Test Solution in a Concentration of 10 pp 100

Prepare a solution in a concentration of 10 pp 1000 (m/v).

6.2. Preparing a Test Solution in a Concentration of 1 pp 100

Prepare a 1 pp 100 (m/v) solution by diluting the previous solution (6.1) to 1/10.

6.3. Lead

Using the technique described in the Compendium, determine the lead content in the 10 pp 100 test solution (6.1). (Lead content should be less than 5 mg/kg.)

6.4. Mercury

Using the technique described in the annex, determine the mercury content in the 10 pp 100 test solution (6.1). (Content should be less than 1 mg/kg.)

6.5. Arsenic

Using the technique described in the annex, determine the arsenic content in the 10 pp 100 test solution (6.1). (Content should be less than 3 mg/kg.)

6.6. Selenium

Weigh 2.60 g potassium anhydrous sulfite, a quantity which contains 1.5 g sulfur dioxide. Dissolve it under heat in 7 ml of distilled water and 2 ml of concentrated hydrochloric acid (R). Let cool, then add 3 ml of formaldehyde solution (R). Let sit for 10 minutes. Place the tube in a 100 °C water bath and add 50 mg of pulverized potassium anhydrous sulfite which is free of selenium (R). Leave the tube in the 100 °C water bath for 15 minutes. If a pink coloration develops, it should be less intense than that of a control prepared in the same way using 2.60 g of selenium-free potassium anhydrous sulfite (R) to which was added 0.45 ml of a selenium dioxide solution in a concentration of 100 mg of selenium per liter (R). (Selenium content, with respect to the sulfur dioxide, should be less than 10 mg/kg).

6.7. Sodium

Prepare 10 ml of a 1 pp 100 (m/v) solution as indicated in paragraph 6.2 with 2 ml of acetic acid (R). Evaporate the solution in a 100 °C water bath until it is reduced to 1/2.

Pour into a 100 ml volumetric flask. Fill with water to the gauge line. Quantitatively analyze the sodium using flame photometry. (Sodium content should be less than 2 pp 100).

6.8. Chlorides

Place 0.5 ml (concentration: 10 pp 100) of solution as prepared under paragraph 6.1 in a dish with 10 ml of water and 3 ml of 10 pp 100 sulfuric acid solution (R). Evaporate in a 100 °C water bath to reduce the volume to 5 ml. Decant in a test tube. Bring the volume up to 15 ml, then add 5 ml of 10 pp 100 nitric acid (R) and 0.5 ml of 5 pp 100 silver nitrate solution (R). The liquid should remain clear ; or else, any clouding which occurs should be less intense than that in a control prepared as indicated in the Annex. (Chloride content, expressed in terms of hydrochloric acid, should be less than 1 g/kg).

6.9. Iron

Using the technique described in the Compendium, determine the iron content in the 10 pp 100 (m/v) test solution (6.1) using atomic absorption spectrophotometry. (Iron content should be less than 50 mg/kg SO₂.)

7. QUANTITATIVE ANALYSIS

Sulfur dioxide - Place 50 ml of a disodium ethylene diamine tetraacetate solution (120 mg per liter) in a 200 ml conical flask. Add 10 ml of the freshly prepared 1 pp 100 potassium anhydrous sulfite solution and titrate with 0.05M iodine. Let n be the volume in ml ; 1 ml of 0.05M iodine corresponds to 3.2 mg of sulfur dioxide.

Sulfur dioxide content per 100 g: $3.2n$

Potassium anhydrous sulfite should contain at least **51.8 pp 100** sulfur dioxide.

8. STORAGE

This product reacts with air and should be kept in hermetically sealed containers.

POTASSIUM CASEINATE

OENO 35/2000;
OIV-OENO 673-2021

1. OBJECTIVE, ORIGIN AND SCOPE OF APPLICATION

Potassium caseinate is obtained from fresh or pasteurized skimmed milk by acid coagulation of the casein (see monograph), neutralization using potassium hydroxide and drying with a spray dryer. It is used for the fining of wines.

2. LABELING

The label should indicate the product's purity and safety and storage conditions.

3. PROPERTIES

Potassium caseinate is a white powder with a slightly yellowish tint, whose characteristic odor is typical of that of milk proteins. It exhibits no unusual odor or taste. It yields a colloidal solution in water.

4. TESTS

4.1. pH

In a water solution with 5 g of potassium caseinate per 100 ml of water, the pH should be between 6.0 and 8.0 ± 0.5

4.2. Desiccation loss

As determined upon constant weight for a sample of approximately 2 g, weight loss at 100-105 °C should not be greater than 10%.

All of the following limiting values are for dry product.

4.3. Ash

Without exceeding 550 °C, burn the residue from the desiccation loss test. The weight of the ash should not be greater than 7%.

4.4. Preparing the Test Solution

After weighing, dissolve the ash in 2 ml of concentrated hydrochloric acid (R) and 10 ml of water. Heat to trigger dissolution and fill to 50 ml with water.

4.5. Potassium

Determine the potassium content using flame photometry on the test solution prepared under Paragraph 4.4. (Potassium content should be less than 2 pp 100).

4.6. Iron

Determine the iron content using atomic absorption spectrophotometry on the test solution prepared under paragraph 4.4. (Iron content should be less than 200 mg/kg).

4.7. Lead

Using the technique described in the Compendium, determine the lead content in the test solution (4.4). (Lead content should be less than 5 mg/kg.)

4.8. Mercury

Using the technique described in the annex, determine the mercury content in the test solution (4.4). (Mercury content should be less than 1 mg/kg.)

4.9. Arsenic

Using the technique described in the annex, determine lead the arsenic content in the (4.4). (Arsenic content should be less than 3 mg/kg.)

4.10. Total Nitrogen

Place about 0.20 g of precisely-weighed potassium caseinate in a mineralization cucurbit with 15 ml of concentrated sulfuric acid (R), 2 g of mineralization catalyst (R) and proceed as indicated in the method described in the Annex. Total nitrogen content should not be less than 13 pp 100.

4.11. Fats

The fat content measured as per the method described in the Annex should not exceed 2 pp 100 by weight.

5. STORAGE

Potassium caseinate should be stored in airtight containers, for example, in paper bags lined with polyethylene, at a temperature of between 5 and 20 °C at a relative humidity of less than 65%. The shelf life of potassium caseinate is 24 months.

POTASSIUM D,L-TARTRATE
Potassium D,L-2,3-dihydroxybutanedioate
Potassium racemate
COOK-CHOH-CHOH-COOK = 226.3
OENO 42/2000

1. OBJECTIVE, ORIGIN AND SCOPE OF APPLICATION

Potassium D,L-tartrate is a salt used to deacidify musts and wines and to remove excess calcium.

Its use is subject to certain regulations.

2. LABELING

The label should indicate product purity as well as its safety and storage conditions. It should also clearly state that this is a racemic mixture of the two isomers D and L of tartaric acid, thereby avoiding the supposition that it is the natural L-tartaric acid found in grapes.

3. PROPERTIES

This product is the dipotassic salt of D,L-tartaric acid or racemic tartaric acid $K_2C_4H_4O_6$.

It is found in the form of white crystals or granulated white powder and is highly soluble in water.

4. TESTS**4.1. Desiccation Loss (volatile substances)**

After 4 hours of desiccation in a 105 °C oven, weight loss should not exceed 1 pp 100.

4.2. Preparing the Solution for Tests

Place 10 g of potassium racemate in a 100 ml volumetric flask and fill to the gauge line with water.

Perform the same tests on this solution as indicated in the monograph on neutral potassium tartaric, including sodium, and observe the same limits.

4.3. Distinguishing Potassium D,L-Tartrate from Neutral Potassium Tartrate

Proceed as indicated in the monograph on neutral potassium tartrate. No white, crystalline precipitate should form instantaneously.

4.4. Lead

Using the technique described in the Annex, determine the lead content. Content to be less than 5 mg/kg.

4.5. Mercury

Using the technique described in the Annex, determine the mercury content. Content to be less than 1 mg/kg.)

4.6. Arsenic

Using the technique described in the Annex, determine the arsenic content. Content to be less than 3 mg/kg.

4.7. Oxalate

Using the technique described in the Annex, determine the mercury content in the test solution (4.2) (The content, expressed as oxalic acid, should be less than 100 mg/kg.)

5. STORAGE

Potassium tartrate should be stored in hermetically sealed containers.

POTASSIUM HEXACYANOFERRATE (II)

Potassium ferrocyanide

Cianuretum ferroso - Kalium $K_4[Fe(CN)_6] \cdot 3H_2O = 422.40$ **SIN NO. 536**

OENO 36/2000

1. OBJECTIVE, ORIGIN AND SCOPE OF APPLICATION

Potassium hexacyanoferrate (II) is found in the form of yellow, monoclinic crystals having no odor and with a bitter, salty flavor. Density is 1.935 at 20 °C.

This salt is slightly efflorescent and begins to lose its water of crystallization at approximately 60 °C. In an oven at 100 °C, it dehydrates completely, becoming white and hygroscopic.

Freshly prepared aqueous solutions are yellow and decay slowly in light with the release of alkalinity. They take on a greenish color by forming a small quantity of Prussian blue.

Potassium hexacyanoferrate (II) is used to remove iron (III) and iron (II) ions in wines, which could cause iron breakdown. It is also used to avoid copper breakdown. It is used, more generally, to reduce the heavy metal content.

Its use must be strictly controlled by mandatory monitoring.

2. LABELING

The label should indicate the product's purity as well as its safety and storage conditions.

3. IDENTIFYING PROPERTIES

The aqueous solution at 1 pp 100 (m/v) yields hexacyanoferrate (II) ion and potassium reactions, particularly with the iron (III) cation, resulting in a dark blue iron (III) hexacyanoferrate (II) (Prussian blue) precipitate which is insoluble in dilute mineral acids. With the copper cation, it forms a purple copper (II) hexacyanoferrate (II) precipitate that is insoluble in dilute mineral acids.

4. SOLUBILITY

Water at 20 °C	265 g/l
Water at 100 °C	740 g/l

5. TESTS

5.1. Desiccation Loss

Place 1 g of powdered potassium hexacyanoferrate (II) in a calibrated dish and dry in an oven at 100 °C until it has a constant weight. Weight loss should be between 12 and 13 pp 100.

5.2. Insoluble Products

Dissolve 10 g of potassium hexacyanoferrate (II) in 100 ml of water. The solution should be clear.

5.3. Preparing the Test Solution

Calcine 1 g of potassium hexacyanoferrate (II) in a silica dish , but without exceeding 550 °C. Take up the residue with 10 ml of water and 2 ml of concentrated nitric acid (R). Decant in a 50 ml volumetric flask. Add 5 ml concentrated ammonium hydroxide (R). Fill to 50 ml with distilled water. Filter.

5.4. Chlorides

To 2.5 ml of this test solution (5.3), add 5 ml nitric acid diluted to 10 pp 100 (R), 12.5 ml of distilled water and 0.5 ml of 5 pp 100 silver nitrate (R). If any opalescence develops, it should be less intense than that observed in a control prepared as indicated in the Annex. (Chloride content, expressed in terms of hydrochloric acid content, should be less than 1 g/kg).

5.5. Sulfates

Add 2 ml hydrochloric acid diluted to 10 pp 100 (R) to a 5 ml test solution (5.3), increase to 20 ml with distilled water and add 2 ml of a barium chloride solution (R). The mixture should be clear ; or else, any opalescence observed after 15 minutes should be less intense than that of the control prepared as indicated in the annex. (Sulfates content, as expressed for sulfuric acid, should be lower than 1 g/kg.)

5.6. Sulfides

In the 100 ml flask of a distilling apparatus equipped with a small rectifying column or other anti-priming device (designed to prevent the direct flow of liquid fractions in the flask into the distillate), dissolve 1 g of potassium hexacyanoferrate (II) in 10 ml of hydrochloric acid diluted to 10 pp 100 (R) and 10 ml of distilled water. Distill and collect 5 ml of distillate in 5 ml of 1M sodium hydroxide.

Take 0.5 ml of this distillate and add 18.0 ml of distilled water and 1 ml of a lead nitrate solution in a concentration of 1 g per liter (R). The

resulting brown coloration should be less intense than that of a control prepared by adding 0.5 ml of hydrogen sulfide solution in a concentration of 1 g of sulfur per liter (R), 18 ml of distilled water and 1 ml of lead nitrate in a concentration of 1 g per liter (R). (Sulfide content, expressed in terms of sulfur, should be less than 100 mg/kg).

5.7. Cyanides

In a 40 ml volumetric flask containing 25 ml of distilled water and 2.5 ml of pH 7.5 buffer solution (R), place 40 mg of potassium hexacyanoferrate (II). After dissolving, add immediately 0.3 ml of 0.1 pp 100 T chloramine solution (R). Wait 90 seconds, then add 6 ml of pyridine-pyrazolone reagent (R).

Fill to 40 ml with distilled water and mix. The resulting coloration should not be more intense than that obtained by treating in the same way 4 ml of freshly prepared potassium cyanide solution assayed at 1 mg of hydrogen cyanide per liter (R). (Free cyanide content, expressed in terms of hydrogen cyanide, should be less than 100 mg/kg).

5.8. Lead

Using the technique described in the Compendium, determine the lead content in the solution (5.3). (Lead content should be less than 5 mg/kg.)

5.9. Mercury

Using the technique described in the annex, determine the mercury content in the test solution (5.3). (Mercury content should be less than 1 mg/kg.)

5.10. Arsenic

Using the technique described in the annex, determine the arsenic content in the test solution (5.3). (Arsenic content should be less than 3 mg/kg.)

5.11. Ammonia

Place 2 g of potassium hexacyanoferrate (II), 25 ml of distilled water and 5 ml of 30 pp 100 sodium hydroxide (R) in the flask of a distilling apparatus. Distill and collect 20 ml of distillate in 40 ml of 4 pp 100 boric acid (R) in the presence of methyl red. 1.2 ml of 0.1M hydrochloric acid should be sufficient to turn the indicator. (Total ammonia content should be less than 100 mg/kg).

6. STORAGE

Potassium hexacyanoferrate (II) should be stored in airtight bags away from moisture.

POTASSIUM HYDROGEN CARBONATE**Potassium bicarbonate****KHCP₃ = 100.1**

OENO 37/2000

1. OBJECTIVE, ORIGIN AND SCOPE OF APPLICATION

This product is used to deacidify musts and wines. The transport of potassium ions causes salification of free tartaric acid and the formation of potassium hydrogen tartrate.

The use of this product is subject to regulation.

2. LABELING

The label should indicate the product's purity and storage and storage conditions.

3. CENTESIMAL COMPOSITION

Carbon dioxide	43.97
Potassium	39.06

4. PROPERTIES

Potassium hydrogen carbonate is found in the form of a white, odorless powder which is slightly hygroscopic. It leads to carbonate-based reactions.

5. SOLUBILITY

Water at 20 °C 600 g/l

Insoluble in alcohol, 95% by vol.

Soluble with effervescence in dilute acid solutions (acetic, hydrochloric, etc.).

6. TESTS**6.1. Desiccation Loss**

After 4 hours of desiccation in an oven at 105 °C, weight loss should be no more than 2 pp 100.

6.2. Preparing the Solution for Tests

Place 10 g of potassium hydrogen carbonate in a 100 ml volumetric flask and fill with water.

6.3. Substances Insoluble in Water

Filter the solution prepared for testing under Paragraph 6.2. The residue, when dried at 105 °C then calcined at 550 °C, should not be greater than 0.1 g (or 1 pp 100).

6.4. Iron

Using the atomic absorption spectrometry technique detailed in the Compendium, analyze the iron content in the test solution (6.2).

6.5. Lead

Using the technique set forth in the Annex, analyze lead content in the test solution (6.2). (Lead content should be less than 5 mg/kg).

6.6. Mercury

Using the technique described in the Annex, determine the mercury content in the test solution (6.2). (Content should be less than 1 mg/kg.)

6.7. Arsenic

Using the technique described in the Annex, determine the arsenic content in the test solution (6.2). (Content should be less than 3 mg/kg.)

6.8. Sodium

Analyze the sodium content in the test solution (6.2) using flame photometry. (Sodium content should be less than 1 pp 100).

6.9. Potassium Hydrogen Carbonate Content

Dissolve approximately 2 g of a test sample, weighed precisely, in 50 ml of 1M hydrochloric acid solution. Titrate the excess hydrochloric acid using a 1M sodium hydroxide solution in the presence of methyl red.

The product intended for wine-making should contain a minimum of 98 pp 100 potassium hydrogen carbonate.

7. STORAGE

Potassium hydrogen carbonate should be stored in airtight containers away from moisture.

POTASSIUM HYDROGEN SULFITE**Potassium bisulfite****Potassium acid sulfite** **$\text{KHSO}_3 = 120.2$** **SIN No. 228**

OENO 38/2000;

OIV-OENO 646-2019

1. OBJECTIVE, ORIGIN AND SCOPE OF APPLICATION

Potassium hydrogen sulfite is used in oenology because of the proportion of sulfur dioxide it contains.

2. LABELING

The label should indicate the weight per liter or per kilogram of sulfur dioxide and the storage and safety conditions.

There are regulatory limits restricting the sulfur dioxide content in wines.

3. CENTESIMAL COMPOSITIONSO₂ 53.30

K 32.53

4. PROPERTIES

Potassium hydrogen sulfite is found in the form of a colorless or slightly yellow solution obtained by passing a current sulfur dioxide through an aqueous potassium hydroxide solution.

Hydrogen sulfite solutions are unstable and should not contain less than 70 g/l or more than 200 g/l SO₂.

5. IDENTIFYING CHARACTERISTICS

Potassium hydrogen sulfite solutions yield reactions of potassium and sulfur dioxide and are slightly acidic (pH of approximately 5).

6. TESTS

The tests are identical to those detailed in the monograph on potassium anhydrous sulfite, as are the limiting content levels for lead, mercury, iron, arsenic, selenium and chlorides.

7. QUANTITATIVE ANALYSIS

Place 50 ml of cold water in a 200 ml conical flask, then add 5 ml of potassium hydrogen sulfite solution. Dilute so that the solution has a concentration of approximately 1 pp 100 SO₂ and titrate with 0.1M iodine in the presence of starch. Let n be the volume of iodine used.

The sulfur dioxide (SO₂) content of the solution, expressed in pp 100 (m/v), is $0.64 \times n$ (concentration cannot be less than 70 g/L).

8. STORAGE

Potassium hydrogen sulfite solutions containing more than 15 pp 100 (m/v) of sulfur dioxide must not be stored at low temperatures, in order to avoid the risk of crystallization.

POTASSIUM HYDROGEN TARTRATE
Potassium L-2,3-dihydroxy hydrogen butanedioate
Monopotassic tartrate
Potassium bitartrate
COOH-CHOH-CHOH-COOK = 188.17
SIN No. 336 i
OENO 39/2000

1. OBJECTIVE, ORIGIN AND SCOPE OF APPLICATION

This addition of potassium hydrogen tartrate, commonly called potassium bitartrate, promotes the crystallization of tartaric acid salts when cold-treating wines.

2. LABELING

The label should indicate the product's purity, size grading, and safety and storage conditions.

3. PROPERTIES

This is an anhydrous monopotassic salt of L(+) tartaric acid $C_4H_5O_6K$. It is found in the form of white crystals or white granulated powder having a slightly acidic taste.

4. SOLUBILITY

Water at 20 °C 5.2 g/l
Water at 100 °C 61 g/l
Insoluble in alcohol

5. TESTS

5.1. Desiccation Loss (Volatile Substances)

After 4 hours of drying in an oven at 105 °C, weight loss should be no more than 1 pp 100.

5.2. Preparing the Solution for Tests

Place 10 g potassium hydrogen tartrate, 50 ml water and 1 ml concentrated hydrochloric acid in a 100 ml volumetric flask. Stir and fill to the top with water.

Perform the same tests on this solution as those indicated in the monograph on L(+) tartaric acid (with the exception of chlorides), and observe the same limits.

5.3. Sodium

Using the flame photometry technique described in the Compendium, analyze sodium content in the test solution (5.2). (Sodium content should be less than 1 pp 100,)

5.4. Iron

Add 1 ml concentrated hydrochloric acid (R) and 2 ml potassium thiocyanate solution having a concentration of 5 pp 100 (R) to 10 ml test solution (5.2). The red color produced should not be more intense than that of a control prepared using 1 ml of an iron (III) salt solution in a concentration of 0.010 g iron per liter (R), 9 ml water, and the same quantities of the same reagents (content should be less than 10 mg/kg).

Iron can also be analyzed quantitatively by atomic absorption spectrometry, in accordance with the technique described in the Compendium.

5.5. Lead

Using the technique described in the Compendium, determine lead content in the test solution (5.2). (Lead content should be less than 5 mg/kg.)

5.6. Mercury

Using the technique described in the annex determine the mercury content in the test solution (5.2). (Mercury content should be less than 1 mg/kg.)

5.7. Arsenic

Using the technique described in the annex, determine the arsenic content in the test solution (5.2). (Arsenic content should be less than 3 mg/kg.)

5.8. Oxalate

Using the technique described in the annex, determine oxalate content in the test solution (5.2). (Oxalate content, expressed in the form of axalic acid, should be less than 100 mg/kg.)

6. STORAGE

Potassium hydrogen tartrate should be stored in hermetically sealed containers.

POTASSIUM SORBATE
Potassium-2,4-hexadienoate
Kalii sorbas
CH₃-CH=CH-CH=CH-COOK
C₆H₇O₂K = 150.2
SIN No. 202
OENO 40/2000

1. OBJECTIVE, ORIGIN AND SCOPE OF APPLICATION

This product is used as a preservative. Potassium sorbate releases 74% sorbic acid, whose anti-fungal properties inhibit the spread of yeast. Its use is limited to 200 mg/l, expressed in the form of sorbic acid.

Sorbic acid is not a bactericide. It is metabolized by certain bacteria and has a characteristic "geranium" taste.

For this reason, its presence in wine does not make it possible to remove SO₂.

2. LABELING

The label should indicate the purity of the product, its sorbic acid content and its safety and storage conditions.

3. CENTESEMAL COMPOSITION

Sorbic acid	74.64
Potassium	26.03

4. SOLUBILITY

Water at 20 °C	highly soluble
Alcohol, 95% by vol.	moderately soluble (≅14 g/l)
Ethyl ether	insoluble

5. IDENTIFYING PROPERTIES

5.1. White, water soluble powder or granules; the solution thereof is neutral when phenolphthalein (R) is added, and alkaline when adding methyl red (R).

5.2. Stir 20 mg potassium sorbate with 1 ml brominated water (R) and 1 drop of acetic acid (R). The color should disappear.

5.3. A solution containing 5 mg potassium sorbate per liter of water has an absorption band of 256 nm.

5.4. A aqueous solution (concentration: 10 pp 100) precipitates using acids and exhibits the characteristics of potassium.

6. TESTS

6.1. Solubility

Verify complete solubility in water and in alcohol.

6.2. Desiccation Loss

1 g potassium sorbate in an oven set at 105 °C should not lose more than 1/100 of its weight in 3 hours.

6.3. Preparing the Solution for Tests

Dissolve 1 g of potassium sorbate in 40 ml of water in a 50 ml volumetric flask. Add 0.5 ml concentrated nitric acid (R). Fill to the gauge line with water and filter.

6.4. Chlorides

Add 0.5 ml of nitric acid diluted to 10 pp 100 (R), 17 ml of water and 0.5 ml of 5 pp 100 silver nitrate (R) to 2.5 ml of the test solution as prepared under Paragraph 4. The resulting opalescence should be less than that of a control prepared as indicated in the Annex. (Chloride content, expressed in terms of hydrochloric acid, should be less than 1 g/kg).

6.5. Sulfates

Add 1 ml of diluted hydrochloric acid diluted to 10 pp 100 (R), 14 ml of water and 2 ml of barium chloride solution (R) to 5 ml of the test solution as prepared under paragraph 6.4. The mixture should be clear; or else, the opalescence observed after 15 minutes should be less than that of a control prepared as indicated in the Annex. (Sulfate content, expressed in terms of sulfuric acid, should be less than 1 g/kg).

6.6. Heavy Metals

Dissolve 1 g of potassium sorbate in 15 ml of water. Add 2 ml of pH 3.5 buffer solution (R) and 1.2 ml of thioacetamide reagent (R). The mixture should remain colorless, or less intensely colored than a solution containing 1 g of the same potassium sorbate in 15 ml of water. If there is an increase in color, it should be equal to that of the control containing 20 µg of lead. For this comparison, use the same system described for sorbic acid. (Heavy metal content, expressed in terms of lead, should be less than 10 mg/kg).

6.7. Lead

Using the technique described in the Compendium, determine lead content in the test solution (6.3). (Lead content should be less than 5 mg/kg).

6.8. Mercury

Implementing the technique detailed in the Annex, determine mercury content in the test solution (6.3). Content should be less than 1 mg/kg.

6.9. Arsenic

Implementing the technique detailed in the Annex, determine the arsenic content in the test solution (6.3). Content should be less than 3 mg/kg.

6.10. Aldehyde Determination

Add 05 ml nitric acid diluted to 10 pp 100 (R) and 14 ml water to 2.5 ml of the test solution (6.3). Add 0.5 ml fuchsin solution bleached using sulfuric acid (R) to 1 ml of this solution and, after 15 minutes, compare to a control tube obtained using 0.5 ml of the same reagent and 1 ml formaldehyde in solution in a concentration of 20 µg per milliliter. The color should be less intense than that of the control. (Aldehyde content, expressed in the form of formaldehyde, should be less than 1 g/kg.).

6.11. Quantitative Analysis

This analysis should be performed using product to be analyzed that has been previously dried in a desiccator with sulfuric acid for 24 hours.

Add a weight, **p** (in g) of dried product of about 0.2 g to the wash bottle of a steam distillation device, along with 1 g of tartaric acid and 10 ml of water. Distill at least 250 ml (until the steam does not entrain any more acid). Titrate the distilled acidity with 0.1M sodium hydroxide solution ; Let **n** be the number of ml used. 1 ml 0.1M sodium hydroxide corresponds to 0.01502 g potassium sorbate.

Potassium sorbate content in percent of the product tested:

$$1.502n / p$$

Titration of the potassium sorbate analyzed should give at least 98 pp 100 for the dried product.

7. STORAGE

Potassium sorbate should be stored in an airtight container away from light to retard oxidation.

POTASSIUM-L(+)- TARTRATE
Potassium-L-2,3-dihydroxybutanedioate
Dipotassium tartrate
Neutral potassium tartrate
COOK-CHOH-COOK,(H₂O)_{1/2} = 235.3
SIN No. 336 ii
OENO 41/2000

1. OBJECTIVE, ORIGIN AND SCOPE OF APPLICATION

Dipotassium L-tartrate is used to deacidify musts and wines. Its use is subject to the regulatory restrictions in force in certain countries.

2. LABELING

The label should indicate product purity (greater than or equal to 98% in the product by dry weight), its safety and storage conditions, and the fact that deacidification of wine is subject to certain requirements.

3. PROPERTIES

This is the dipotassium salt of L-tartaric acid (positive rotatory power, sometimes written as L(+) tartaric), which crystallizes with a half-molecule of water:

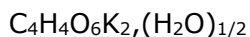

It is made in the form of white crystals or granulated white powder. It is highly soluble in water.

4. TESTS**4.1. Desiccation Loss (Volatile Substances)**

After 4 hours of desiccation in a 105 °C oven, weight loss should not exceed 4 pp 100.

4.2. Preparing the Solution for Tests

Place 10 g of neutral potassium tartrate in a 100 ml volumetric flask and fill to the gauge line with water.

Perform the same tests on this solution as indicated in the monograph on L(+) tartaric acid and observe the same limits.

4.3. Sodium

Implementing the flame photometry technique detailed in the Compendium, determine sodium content in the test solution (4.2). (Sodium content should be less than 1 pp 100.)

4.4. Iron

Add 1 ml concentrated hydrochloric acid (R) and 2 ml potassium thiocyanate solution (concentration : 5 pp 100) (R) to 10 ml of the test solution (4.2). The red color should not be more intense than that of the control prepared using 1 ml of an iron (III) salt solution (concentration : 0.010 g iron per liter) (R), 9 ml water, and the same quantities of the same reagents. (Content should be less than 10 mg/kg.)

The iron content may also be analyzed using the atomic absorption spectrometry technique described in the Compendium.

4.5. Lead

Applying the method set forth in the Compendium, analyze the lead content in the test solution (4.2). Lead content should be less than 5 mg/kg.)

4.6. Mercury

Using the technique described in the Annex, determine the mercury content in the test solution (4.2). (Content to be less than 1 mg/kg.)

4.7. Arsenic

Using the technique described in the Annex, determine the arsenic content in the test solution (4.2). (Content to be less than 3 mg/kg.)

4.8. Distinguishing Between Potassium Tartrate and Potassium Racemate

Place 10 ml of water in a test tube with 1 ml of the test solution prepared under paragraph 4.2, 1 ml crystallizable acetic acid (R) and 2 ml of 25% calcium acetate solution (R). No white, crystalline precipitate should form instantaneously.

4.9. Oxalate

Using the technique described in the Annex, determine the oxalate content in the test solution (4.2). (The oxalate content, expressed in terms of oxalic acid, should be less than 100 mg/kg after drying.)

5. STORAGE

Potassium tartrate should be stored in hermetically sealed containers.

PROTEIN PLANT ORIGIN FROM WHEAT, PEAS and POTATOES

OENO 28/2004;
OIV-OENO 495-2013;
OIV-OENO 557-2015;
OIV-OENO 575-2016

1 OBJECT, ORIGIN AND FIELD OF APPLICATION

The plant protein matter described in this monograph is extracted from wheat (*Triticum vulgare*), peas (*Pisum sativum*), or potatoes (*Solanum tuberosum*). It is mainly made up of proteins and may contain, as minority constituents, carbohydrates (fibres, starch, sugars), fats and minerals. It is intended for human consumption.

The plant protein matter is used for the fining of musts and wines.

It comes in the form of a whitish, beige or yellowish powder. It is totally or partially soluble in water depending on the pH. It can also be in liquid form with content more than or equal to 50 g/l. The solutions are stabilised with sulphur dioxide.

2 LABELLING

The following indications must appear on the label of the package: plant origin of the protein, minimal protein content, safety and storage conditions and expiry date. Without prejudice to the provisions in force in the countries where these products are marketed to be used, GMO origin of the raw material is indicated on the package label.

3 TEST TRIALS

3.1 Loss from desiccation

In a silica capsule with a 70 mm diameter with a lid, place 2 g of proteins. Dry in incubator at 105°C for 6 hours. Allow to cool in open capsule and desiccator. Weigh.

Weight loss must not be more than 12% of the powder preparation.

All limits set below concern dry weight.

3.2 Determination of total nitrogen

On a 0.2 g test sample proceed as indicated in chapter II of the Oenological Codex.

The total nitrogen must be more than 10% of the powder weight (corresponding to about 65% in protein).

3.3 Ashes

Incinerate the residue left from the determination of the loss from desiccation (3.1) by progressively heating at 600°C in a muffle oven until a white residue is obtained and after having sprinkled it with 0.2 to 0.3 g of ashes paraffin in order to avoid mass overflow.

Total ashes must be less than 8%.

3.4 Preparation of the test trial solution

After weighing, dissolve the ashes in 2 ml of concentrated hydrochloric acid (R) and 10 ml of water. Heat in order to activate the dissolving and add distilled water until a volume equal to 25 times the weight of dry protein is obtained. 1 ml of this solution contains mineral substance of 0.04 g of dry protein.

3.5 Iron

1 ml of concentrated hydrochloric acid (R), a drop of potassium permanganate at 1% (R) and 2 ml of potassium thiocyanate at 5% (R) were added to 10 ml of the test solution prepared according to 3.4.

If a red colouration appears, it must be lighter than the control prepared with 6 ml of iron solution (III) at 0.010 g per litre (R), 4 ml of water and the same quantities of concentrated hydrochloric acid (R) and potassium thiocyanate at 5% (R).

The iron content must be less than 150 mg/kg, with the exception of proteins from peas and potatoes, whose content should be less than 300 mg/kg.

It is also possible to proceed with the determination of iron by spectrophotometric atomic absorption according to the method described in chapter II of the International Oenological Codex.

3.6 Chromium

In a 50 ml conical flask, place 10 ml of solution prepared according to 3.4, 1 ml of 15% (R) ammonium persulphate solution at, 0.5 ml of a 1% (R) silver nitrate solution at. Heat and add drop by drop until a persistent pink colouration appears of the 3% (R) potassium permanganate solution at. Put a few drops in excess and maintain a gentle boil for 10 minutes. If during boiling, the solution becomes discoloured, add potassium permanganate. After 10 minutes, introduce drop by drop diluted hydrochloric acid at 1/10 (R) until the solution is once again colourless.

After cooling, transfer to a 20 ml graduated flask and add 2 ml of 0.05% diphenylcarbazide in solution at in freshly prepared alcohol (R). Bring to 20 ml.

If a red purplish colouration appears, it must be lighter than that obtained by treating 4 ml of 0.001 g of chromium per litre (R) potassium dichromate solution at by 2 ml sulphuric acid at 5% (R), 5 ml of distilled water, by adding after mixing 2 ml of diphenylcarbazide solution at 0.05% in alcohol (R) and by bringing to 20 ml.

Chromium content must be less than 10 mg/kg.

It is also possible to proceed with the determination of chromium by atomic absorption according to the method described in chapter II of the International Oenological Codex.

3.7 Copper

2.5 ml of the test trial solution prepared according to 3.4, are placed in a test tube with 7.5 ml of water, 0.5 ml of hydrochloric citric solution (R), 1 ml of ammonium hydroxide 5 M (R), 0.5 ml of sodium diethyldithiocarbamate reagent (R). If a yellow colouration appears, it must not be darker than that obtained by adding the same quantities of the same reagents to 4.7 ml of a copper solution at 1 mg per litre (R) brought to 10 ml.

Copper content must be less than 35 mg/kg.

It is also possible to proceed with the determination of copper by atomic absorption according to the method described in chapter II of the International Oenological Codex.

3.8 Zinc

To 1.25 ml of the test solution prepared according 3.4, add 3.75 ml of distilled water, 5 ml of acetate buffer solution (R), 1 ml of sodium thiosulphate solution at 25% (m/v) (R), 5 ml of dithizone solution at 25 mg per litre in chloroform or dichloromethane (R). Shake for 2 minutes. Separate the organic phase; its colouration must be lighter than that obtained by treating 2 ml of zinc solution at 1 mg per litre (R) with the same quantities of the same reagents.

Zinc content must The zinc content must be less than 50 mg/kg, with the exception of proteins from peas, whose content should be less than or equal to 150 mg/kg.

It is also possible to proceed with the determination of zinc by atomic absorption according to the method described in chapter II of the International Oenological Codex

3.9 Lead

Using the test trial solution (3.4), perform the determination using the method described in chapter II of the International Oenological Codex.

Lead content should be less than 5 mg/kg.

3.10 Mercury

Perform the determination of mercury using the method described in chapter II of the International oenological Codex.

Mercury content should be less than 1 mg/kg

3.11 Arsenic

Perform the determination of arsenic using the method described in chapter II of the International oenological Codex.

Arsenic content should be less than 3 mg/kg.

3.12 Cadmium

Perform the determination of cadmium using the method described in chapter II of the International Oenological Codex.

Cadmium content should be less than 1 mg/kg.

4 MICROBIOLOGICAL CONTROL

4.1 Total viable micro-organisms

Proceed as described in Chapter II of the International Oenological Codex.

Content less than $5 \cdot 10^4$ CFU/g.

4.2 *Escherichia coli*

Proceed with counting as described in Chapter II of the International Oenological Codex.

Absence checked on a 1 g sample.

4.3 *Salmonella*

Proceed with counting as described in Chapter II of the International Oenological Codex.

Absence checked on a 25 g sample.

4.4 Coliforms

Proceed with counting as described in Chapter II of the International Oenological Codex.

Content less than 10^2 CFU/g.

4.5 Yeasts

Proceed with counting as described in Chapter II of the International Oenological Codex.

Content less than 10^3 CFU/g.

4.6 Moulds

Proceed with counting as described in Chapter II of the International Oenological Codex.

Content less than 10^3 CFU/g.

5 SEARCH FOR MYCOTOXINS AND PESTICIDE RESIDUES

5.1 Aflatoxins B₁

Proceed with analysis according to ISO method 16050

Content less than 4 µg/kg.

5.2 Aflatoxin B₁, B₂, G₁, G₂

Proceed with analysis according to ISO method 16050

Content less than 4 µg/kg in total.

5.3 Organophosphorous pesticide residues *

Content less than 10 mg/kg.

5.4 Organochlorine pesticide residues*

Content less than 0.1 mg/kg.

5.5 Ochratoxine A

Using an aqueous solution of 5 g/l of plant protein, perform the determination using the method described in the Compendium of methods of analysis of musts and wines.

Content less than 5 µg/kg.

6 RESEARCH SPECIFIC FOR SOLANUM TUBEROSUM

6.1 Glycoalkaloids (□ solanine & □ chaconine)

Proceed with analysis according to AOAC method 997.13

Maximum content less than 300 mg/kg of potatoes protein

7 STORAGE

The plant proteins should be stored in closed containers or in watertight bags impervious to humidity under temperate conditions.

^{_____}
*Method to be determined at a later date.

RECTIFIED ALCOHOL OF AGRICULTURAL ORIGIN

C 6/77-OEN;
OENO 11/2000

1. OBJECTIVE, ORIGIN AND SCOPE OF APPLICATION

Rectified, or "neutral," alcohol obtained by distilling and rectifying alcohol from wine, wine sediments or alcoholic fermentation products derived from from grape or raisin marcs, and all other plant-based substances of agricultural origin.

Rectified alcohol of agricultural origin forms an ingredient of some spirits and special wines.

2. COMPOSITION

At a temperature of 20 °C, 100 parts of this alcohol contain at least 96 parts ethanol.

Note: *The tests and controls described below in italics are not mandatory and are performed only upon request.*

3. PROPERTIES

Colorless, clear, volatile liquid with a penetrating odor and fiery flavor. It is flammable and burns without smoke and with a blue flame.

It should be distilled completely at between 78 and 79 °C.

3.1. Solubility

Neutral alcohol is miscible in water in all proportions with a notable release of heat and contraction of volume. It is also mixable with in acetone, chloroform, ethyl ether, glycerol, and an equal volume of castor oil.

3.2. Characterization Procedure

- Slowly heat a mixture of 1 ml neutral alcohol, twenty drops of concentrated sulfuric acid (R) and 10 g of sodium acetate (R) in a test tube. A strong, characteristic odor of ethyl acetate will be released.

- Mix several drops of alcohol and 1 ml of concentrated sulfuric acid (R), then add several drops of 10 pp 100 potassium dichromate solution. The liquid will become green and emit the odor of ethanal.

- Dilute 0.5 ml of alcohol with 4.5 ml of water. Add 1 ml of 1M sodium hydroxide solution, then slowly add 2 ml of iodized potassium iodide (R). An odor of iodoform will be produced, following by the formation of a yellow precipitate.

3.3. Analysis of Agricultural Origin

This analysis is carried out by measuring the ethanol $^{14}\text{C}/^{12}\text{C}$ ratio (scintillation) in accordance with the method described in the Spirits Compendium.

4. TESTS

4.1. Appearance

Take two identical test tubes made of alkali-lime glass about 250 mm high, fill one with alcohol, the other with water, which will serve as a control. Examine the liquids along the cylinder's axis. The alcohol should not exhibit any noticeable coloration.

In one test tube about 250 mm high and 25 mm in diameter, pour 40 ml of alcohol, then dilute it with 80 ml of water. The mixture should not cloud nor present any odor or foreign taste.

4.2. Foreign Odoriferous Substances

Let 10 ml of alcohol evaporate spontaneously on a strip of white filter paper. No foreign odor should be perceived during or after evaporation.

4.3. Dry Extract or Non-Volatile Residue

In a 25 ml calibrated dish, heat to 100 °C in a water bath, then slowly evaporate 100 ml of alcohol. Weigh. The dry extract should be less than 1.5 g/hl 100% ethanol by volume.

4.4. Heavy Metals

Take up, using 10 ml dilute chlorhydric acid (R), any residue left from the evaporation of 100 ml alcohol during the dry extract analysis. After heating for several minutes in a 100 °C water bath to stimulate dissolution of this residue, decant the acid solution in a 25 ml volumetric flask after the calibrated dish has been washed three times with 5 ml of water and the volume raised to 25 ml. Take a 5 ml sample of this solution in a test tube. Add 2 ml of a pH 3.5 (R) buffer solution, 7.5 ml of water and 1.2 ml of thioacetamide reagent (R). The solution should not produce any white or black precipitates nor any brown or other coloration. At the very least, any coloration produced should be no more intense than that obtained using the general method. (Heavy metal content expressed in lead, after 50% concentration of the alcohol, should be 0.5 mg/l).

4.5. Lead

Using the method set forth in the Compendium, perform the lead analysis lead in the solution obtained in the previous paragraph. (Lead content should be less than 0.5 mg/l).

4.6. Mercury

Using the method described in the annex, carry out the mercury analysis in the solution obtained in Paragraph 4.4. (Mercury content should be less than 0.2 mg/l).

4.7. Arsenic

Using the method described in the annex, carry out the arsenic analysis in the solution obtained in Paragraph 4.4. (Arsenic content should be less than 0.5 mg/kg after 50% alcohol concentration).

4.8. Ketones, propan-2-ol and 2-methylpropan-1-ol

Add 3 ml of water and 10 ml of mercury sulfate (II) solution (R) to 1 ml of alcohol, then heat in a 100 °C water bath. No precipitate should form in the first three minutes.

4.9. Permanganate Decolorization Time (Barbet Test)

Pour 50 ml of the alcohol sample into a flask. Add 2 ml of freshly prepared potassium permanganate solution to 0.20 g/l (R). Place the container in a 15 °C water bath and start a stopwatch. Avoid directly exposing the sample to natural or artificial light during the test.

Simultaneously, place 50 ml of the comparison solution in the 15 °C water bath. This solution is obtained by mixing 3 ml of 5 pp 100 cobalt chloride solution (R), 4.2 ml of 4 pp 100 uranyl nitrate solution (R) and filling to 50 ml with distilled water. Compare the test color to the standard. Stop the timer when the colors are identical. Note the amount of time elapsed. The decolorization time of the permanganate should be at least 20 minutes.

4.10. Sulfured Derivatives

Add approximately 1 ml of mercury, then 20 ml of alcohol to a test tube. Agitate for 1-2 minutes. The surface of the mercury should remain brilliant with no black clouding.

4.11. Methanol**4.11.1 Colorimetric Analysis**

Standard solution: weigh 5 g of methanol in a 50 ml volumetric flask, then top off to the line with ethanol (free of methanol).

In a 1-liter volumetric flask, place 1 g of the preceding solution (i.e., 1.25 ml) containing 125 mg of methanol, 250 ml of pure alcohol (methanol free). Top off with water to 1000 ml.

Test technique: place 1250/A ml of alcohol in a volumetric flask (A is the alcoholmetric titer of the alcohol to be tested.) and fill to the gauge line with water. Place 1 ml of alcohol, diluted to 25 pp 100 in a test tube. Add four drops of 50 pp 100 (m/m) phosphoric acid (R), four drops of 5 pp 100 (m/m) potassium permanganate solution (R), then stir and let sit 10 minutes. Decolorize the permanganate with several (typically 8) drops of 2 pp 100 (m/v) of potassium anhydrous sulfite (metabisulfite) (R), avoiding any excess. Add 5 ml of chromotropic sulfuric acid solution (R). Place in a 70 °C water bath for 20 minutes. No violet color should appear, or in the event it does appear, it should not be more intense than that of a control prepared using the same technique and the same reagents, with 1 ml of the aforementioned standard solution (maximum methanol content is 50 g/hl at 100% vol.).

4.11.2 Gas phase chromatography Analysis

Equipment (example):

Gas phase chromatograph with a flame ionization detector

Semi-polar capillary columns, for example Carbowax 20 M ®.

Test technique:

Prepare a water-alcohol solution using 1 g per liter of the internal standard (4-methylpentane-2-ol) in 50 pp 100 alcohol by volume.

Prepare the solution to be analyzed by adding 5 ml of this solution to 50 ml of alcohol reduced to 50 pp 100 by volume.

Prepare a reference solution of methanol at 100 mg per liter of alcohol at 50 pp 100 by volume. Add 5 ml of the internal standard solution to 50 ml of this solution.

Inject 2 microliters of the solution to be analyzed added to the internal standard solution, into the chromatograph.

The oven temperature should be 90 °C and the supporting gas flow rate should be 25 ml per minute. These settings are given as an example.

S: surface of the methanol peak of the reference solution

S_x: surface of the methanol peak of the solution to be analyzed

i: surface of the internal standard solution peak in the solution to be analyzed

I: surface of the internal standard solution peak in the reference solution

The methanol content, expressed in milligrams per liter of alcohol at 50 pp 100 by volume, is given by the formula:

$$C = 100(I/i)(S_x/S)$$

The content in grams per hectoliter of pure alcohol is 0.20C (maximum content in methanol 50 g/hl of ethanol at 100% by volume).

4.12. Ammonium Hydroxide and Nitrogenous Bases

Pour 50 ml of the alcohol to be examined into a 200 ml flask. Add 40 ml of water and two drops of phosphoric acid ($\rho_{20} = 1.58$). Distill and collect the 80 ml that are returned. Add 2 ml of 10 pp 100 sodium hydroxide ® to the cooled residue. Distill again and collect approximately 7 ml of distillate in a test tube to which had previously been added 2 ml of water and one drop of methyl red solution ®. The distillate should be drawn to the bottom of the tube using a slender tube. Titrate using a solution of 0.01 M hydrochloric acid until the indicator turns to red. Let n be the number of milliliters of 0.01 M hydrochloric acid solution used.

1 ml of 0.01 M hydrochloric acid solution corresponds to 0.00014 g of nitrogen (ammoniacal or volatile nitrogen bases).

The quantity of ammoniacal nitrogen or nitrogenous bases expressed in milligrams of nitrogen per liter of ethanol is:

$$280n/A$$

Where A is the alcoholometric titer by volume of the alcohol studied.

Neutral alcohol should not contain more than 1 mg of nitrogen (ammoniacal or of volatile nitrogenous bases) per liter of ethanol.

(Maximum ammonium hydroxide and nitrogenous base content is expressed in terms of nitrogen is 0.1 g/hl of ethanol at 100% by volume).

4.13. Acidity

Place 100 ml strengthened of 50 pp 100 by volume alcohol in a 250 ml conical flask. Add one drop of phenol red solution (R) and add 0.01 M sodium hydroxide, one drop at a time, until red, where n is the number of milliliters used.

1 ml of 0.01 M sodium hydroxide corresponds to 0.0006 g of acetic acid.

Acidity expressed in milligrams of acetic acid per liter of ethanol is equal to $12n$.

This acidity should be less than 15 mg/l of ethanol (or 1.5 g/hl) at the time the alcohol is delivered.

(Maximum acidity expressed in terms of acetic acid is 1.5 g/hl of ethanol at 100% by volume).

Note: Indicator movement should be stable and clear cut during quantitative analysis of the acidity. If it is not, and especially if the acidity exceeds 15 mg/l, a new test should be conducted after the sample is degassed using the following technique.

100 ml of alcohol at 50 pp 100 by volume is placed in a 250 ml flask whose stopper has two tubes through it.

One tube permits the flask to be kept under a vacuum using a glass filter pump. Pressure is kept between 55 and 65 cm of mercury.

During the procedure, the other tube allows air bubbling from which carbon dioxide is removed by using a sode wash bottle. To accomplish this, the tube has a capillary portion which is submerged in the alcohol. The rate of air flow through the wash bottle is approximately 1 ml per second.

The procedure should last between 3 and five minutes. Titration is accomplished in the same flask.

4.14. Esters

Add 10 ml of 0.1 M sodium hydroxide solution measured with precision to the solution prepared to analyze acidity as detailed under 4.13 (or 100 ml of alcohol at 50% by volume). Cork the flask and stir while maintaining a temperature equal to or slightly higher than 20 °C. After 24 hours of contact, titrate the excess sodium hydroxide using a 0.1 M solution of hydrochloric acid, where n is the number of milliliters used.

To determine the quantity of 0.1 M hydrochloric acid solution which will neutralize 10 ml of 0.1 M sodium hydroxide solution in the presence of the same quantity of alcohol and of the same indicator movement obtained by decreased pH intervals, perform the following test: place 100 ml of degasified 50 pp 100 alcohol in a 250 ml conical flask. Add one drop of phenol red solution (R) and n milliliters of 0.1 M sodium hydroxide. Which cause the indicator to turn to red. Add 10 ml of the 0.1 M sodium hydroxide solution, and, immediately thereafter, add 0.1 M hydrochloric acid solution to obtain the same movement of the indicator, that is, n' of the volume used.

1 ml of 0.1 M sodium hydroxide solution corresponds to 0.0088 g of ethyl acetate. The ester concentration, expressed in milligrams of ethyl acetate contained in 1 liter of ethanol is:

$$176(n^n - n')$$

This content level should not exceed 13 mg for 1 liter of ethanol (or 1.3 g/hl) at the time the alcohol is delivered.

(Maximum ester content expressed in terms of ethyl acetate is 1.3 g/hl of ethanol at 100% of volume).

4.15. Aldehydes

Standard solution: Place 268.3 mg of pure acetal (boiling point : 102°C) in a 100 ml volumetric flask. Top off to the line with 50 pp 100 alcohol by volume, free of aldehydes.

Dilute this solution to 1/10 in 50 pp 100 alcohol by volume, is free of aldehydes. The solution obtained contains 100 mg of ethanal per liter of 50 pp 100 alcohol by volume, or 20 g in 100 liters of ethanol.

Test procedure: Place 10 ml of alcohol reduced to 50 pp 100 by volume in a test tube. In a second test tube, place 5 ml of the solution containing 100 mg of ethanal per liter of alcohol at 50 pp 100 and 5 ml of alcohol at 50 pp 100 by volume which is free of aldehydes. Add to the two tubes 4 ml aniline red chlorhydrate solution decolorized by sulfuric acid (R), stir, and compare the colorations obtained after 20 minutes.

The alcohol to be tested should have a color approximately equal to that of the standard solution.

(Maximum aldehyde content expressed in ethanal is 0.5 g/hl at 100% of volume).

Note concerning 50 pp 100 alcohol by volume without aldehydes: Place 100 ml of alcohol diluted to 50 pp 100 by volume in a 250 ml flask with 2 g of metaphenylene diamine (R) and two pieces of pumice stone. Connect the flask to a reflux condenser and maintain a gentle boil for one hour. After cooling, connect the flask to the distilling apparatus and slowly distill without overheating the walls. Collect 75 ml of distillate in a 100 ml volumetric flask. Fill to the line with distilled water.

4.16. Superior Alcohols

Propan-1-ol, 2-methylpropan-1-ol, 2- and 3-methylbutan-1-ol.

Quantitative analysis by gas phase chromatography (see methanol).

Maximum content for the sum of each of the alcohols: 0.5 g/hl of ethanol at 100% of volume.

4.17. Furfural

Place 10 ml of alcohol reduced to 50% by volume in a test tube with an emery stopper. Add 0.5 ml of aniline (R) and 2 ml of crystallizable

acetic acid (R). Stir. No salmon pink coloration should be perceptible after 20 minutes.

5. STORAGE

The alcohol should be stored in inert containers which will not give off metals, ions or plastic constituents.

The containers, as well as storage methods, must be in compliance with safety standards.

RECTIFIED ALCOHOL OF VITI-VINICULTURAL ORIGINC 6/77-OEN
OENO 12/2000**1. OBJECTIVE, ORIGIN AND SCOPE OF APPLICATION**

Alcohol obtained exclusively by distillation and rectification from wine, grape marcs, wine sediments, or fermented raisins.

Rectified alcohol of viti-vinicultural origin constitutes a constituent of some spirits and special wines.

2. COMPOSITION

At a temperature of 20 °C, 100 parts of this alcohol contain at least 96 parts ethanol.

Note: *The tests and controls described below in italics are not mandatory and are performed only upon request.*

3. PROPERTIES

Colorless, clear, volatile liquid with a penetrating odor and fiery taste. It is flammable and burns without smoke and with a blue flame.

It should be distilled completely at between 78 and 79 °C.

3.1. Solubility

Neutral alcohol is miscible in water in all proportions with a notable release of heat and contraction of volume. It is also mixable with acetone, chloroform, ethyl ether, glycerol, and an equal volume of castor oil.

3.2. Characterization Procedure

- Slowly heat a mixture of 1 ml neutral alcohol, twenty drops of concentrated sulfuric acid (R) and 10 g of sodium acetate (R) in a test tube. A strong, characteristic odor of ethyl acetate will be released.

- Mix several drops of alcohol and 1 ml of concentrated sulfuric acid (R), then add several drops of 10 pp 100 potassium dichromate solution. The liquid will become green and emit the odor of ethanal.

- Dilute 0.5 ml of alcohol with 4.5 ml of water. Add 1 ml of 1M sodium hydroxide solution, then slowly add 2 ml of iodized potassium iodide (R). An odor of iodoform will be produced, following by the formation of a yellow precipitate.

3.3. Determination of Viti-vinicultural Origin

This analysis is carried out by measuring the ethanol ¹⁴C/¹²C ratio (scintillation) in accordance with the method described in the Spirits Compendium.

3.4. If necessary, the viti-vinicultural source of the alcohol can be determined using isotopic methods detailed in the Compendium of Wine and Must Analysis Methods.

4. TESTS

Test are identical to those for rectified alcohol of agricultural origin , but with the following content limits:

4.1. Methanol

Maximum content 50 g/hl of ethanol at 100% by volume.

4.2. Acidity

Maximum acetic acid content 1.5 g/hl of ethanol at 100% by volume.

4.3. Esters

Maximum content of ethyl acetate 1.3 g/hl of ethanol at 100% by volume (or 5 g/hl).

4.4. Aldehydes

Maximum ethanal content 0.5 g/hl of ethanol at 100% by volume.

4.5. Superior Alcohols

Maximum content 0.5 g/hl of ethanol at 100% by volume.

4.6. Preparing the solution for tests

Using 10 ml of dilute hydrochloric acid (R), take up the residue left by evaporating 100 ml of alcohol during the dry extract analysis. After heating for several minutes in a 100 °C water bath to stimulate dissolution of this residue, decant the acid solution in a 25 ml volumetric flask, and wash the dish three times with 5 ml of water and filled to 25 ml.

4.7. Heavy metals

Place 5 ml of the prepared solution in a test tube in accordance with paragraph 4.6. Add 2 ml of pH 3.5 (R) buffer solution, 7.5 ml of water and 1.2 ml of thioacetamide reagent (R). The solution should not yield any white or black precipitate nor any brown or coloring. At the very least, any coloring produced should be no more intense than that obtained using the general method (heavy metals content expressed in terms of lead, after 50% concentration of the alcohol, should be 0.5 mg/l).

4.8. Lead

Using the method set forth in the Compendium, conduct the quantitative lead analysis on the solution prepared for testing (under paragraph 4.6) (lead content should be less than 0.5 mg/l).

4.9. Mercury

Carry out the quantitative mercury analysis on the solution prepared for testing (under Paragraph 4.6), implementing the technique described in the annex (mercury content should be less than 0.2 mg/l).

4.10. Arsenic

Conduct the quantitative arsenic analysis on the solution prepared for testing (Paragraph 4.6), using the method described in the annex (Arsenic content should be less than 0.5 mg/kg).

5. STORAGE

Alcohol should be stored in inert containers which will not give off metals, ions or plastics constituents.

The containers as well as the storage methods must comply with safety standards.

REVERSE OSMOSIS MEMBRANES

OENO 3/95 ;
OENO 30/2000

1. OBJECTIVE, ORIGIN AND SCOPE OF APPLICATION

A reverse osmosis membrane is a membrane belonging to the group of semi-permeable thin-layer composites (known as TFC, or Thin Film Composites).

Reverse osmosis is a must-enrichment treatment. It entails the use of a membrane to remove pure water, thus increasing the concentration of sugars and other constituents in solution in grape musts.

2. PRINCIPLE UNDERLYING THE PROCEDURE

This is a physical process for removing a portion of the water in a must using a semi-permeable membrane acted upon by a pressure gradient at ambient temperature and without changing or degrading its condition.

The equipment used consists essentially of a so-called « booster » pump which feeds a high-pressure pump (under 100 bars, for example) which allows osmotic pressure to be overcome, a membrane block and control apparatuses such as a flow meter, pressure indicator, pressure regulator, etc.

3. COMPOSITION

All equipment used in this Prescriptions must be in compliance with the regulations concerning fittings which come into contact with foodstuffs (pipes, pumps, control apparatuses, joints, etc.) and in particular, the reverse osmosis membrane.

The substances which make up the membrane must be in compliance with the regulations in force.

These membranes are prepared by *in situ* polymerization of a polymer on the surface of a porous substrate. The substrate is typically an polysulfone ultrafilter. The thin layer serves as a discriminating membrane, while the porous substrate provides physical support.

As an example, the structural formula of the polyamide base is as follows:

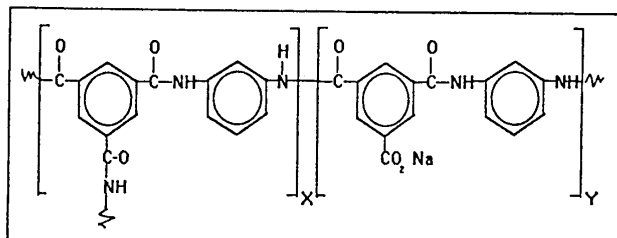

4. IMPLEMENTATION

During the manufacturing process, the membrane passes through a number of extraction baths containing hot water in order to eliminate traces of solvent and residual monomers.

In particular, under normal or unforeseen circumstances it cannot give off any constituents which could pose a threat to human health (with respect to the component most easily measured, i.e., sodium chloride, in particular, it should exhibit a substance-retention rate greater than 99%). It must not cause an undesirable change of the composition of the grape must (or of a solution containing 170 g/l of sugar and 5 g/l of tartaric acid neutralized to a pH of 3.5 by potassium hydroxide), nor can it alter the organoleptic properties of the must.

5. MEMBRANE REGENERATION

As regenerating agent, the operator can use inorganic products permitted under the regulations, provided that the operation ends by washing with water so as to completely remove the regenerating agent before adding the must.

6. LIMITS

- All equipment/materials in contact with food products must be in compliance with the standards in force.

- There should be no perceptible change of the organoleptic properties of the processed must.

Any release of product or derivative constituting a constituent of the membrane must be less than 50 µg/l in its entirety, which is the recommended value, and it must comply with the regulatory limits governing the specific migration of the various materials constituents.

7. SPECIAL RESTRICTIONS

Membranes may be supplied only by approved suppliers or distributors.

Use of the membrane must be monitored and restricted by :

- installing a time meter and a volumeter which are sealed at the permeate outlet,
- the physical impossibility inhering in the process of increasing the concentration of the must beyond the established threshold.

Selective plant fibers

OIV-OENO 578-2017

1. OBJECT, ORIGIN AND SCOPE OF APPLICATION

Selective plant fibers come from the edible parts of certain plants, generally of cereal origin. The plant fibers undergo series of mechanical treatments and extractions that concentrate the active complex without damaging the structure of the plant fiber. The objective is to increase the adsorption capacity.

The activated plant fibers fix some pesticide residues that may be present in wine and ochratoxin A. They are used during the filtration of wines.

2. LABELLING

The label should contain the following indications:

- the name or sales denomination,
- the statement 'Product for oenological use',
- the batch number and expiry date,
- the storage conditions,
- the origin and composition of the fibers,
- the name or company name of the manufacturer,
- the address of the manufacturer,
- the net quantity.

3. CHARACTERISTICS

The product is insoluble and comes in the form of a very fine powder.

4. COMPOSITION

The selective plant fibers contain a minimum of 90% (in mass) insoluble parietal compounds (NDF fraction) in total, determined by the Van Soest method in Annex 1.

5. TRIALS**5.1 Desiccation-related loss**

Place 5 g of product in a desiccator at 90 °C for 15 minutes. The weight loss should not exceed 8% of the initial weight.

All of the limits set below relate to dry products.

5.2 Ashes

Without going above 550 °C, progressively incinerate the residue left in the determination from the desiccation loss.

The weight of the ashes should be less than 1%.

5.3 Products soluble in aqueous solution

Place 10 g of selective plant fibers in a 250 mL container then pour 100 mL of water slowly while mixing by hand to obtain a homogeneous suspension. Collect the selective plant fibers on a filter and rinse the container with distilled water to pick up the residues from the selective plant fibers. After 48 h at a temperature of 45 °C, the loss in soluble products should not exceed 3% of the initial dry matter weight.

5.4 Contaminant adsorption trial*5.4.1 Pesticides*

The capacity for adsorption (KF) of 2-chloro-N-(4'-chlorobiphenyl-2-yl) nicotinamide (Boscalid) by the selective plant fiber, determined according to the method described in Annex 2, should be over or equal to 1000 mg/kg for a dose of 2 g/L selective plant fibers.

5.4.2 Ochratoxin A

For a 2 g/L dose of selective plant fibers, their capacity for adsorption (KF) of ochratoxin A (OTA), determined according to the method described in Annex 3, should be over or equal to 1200 mg/kg.

5.5 Iron

Quantification by atomic absorption spectrometry according to the method described in chapter II of the *International Oenological Codex*.

The iron content should be below 100 mg/kg.

5.6 Copper

Quantification by atomic absorption spectrometry according to the method described in chapter II of the *International Oenological Codex*.

The copper content should be below 25 mg/kg.

5.7 Lead

Quantification by atomic absorption spectrometry according to the method described in chapter II of the *International Oenological Codex*.

The lead content should be below 5 mg/kg.

5.8 Mercury

Quantification by atomic absorption spectrometry according to the method described in chapter II of the *International Oenological Codex*.

The mercury content should be below 1 mg/kg.

5.9 Arsenic

Quantification by atomic absorption spectrometry according to the method described in chapter II of the *International Oenological Codex*.

The arsenic content should be below 1 mg/kg.

5.10 Cadmium

Quantification by atomic absorption spectrometry according to the method described in chapter II of the *International Oenological Codex*.

The cadmium content should be below 1 mg/kg.

5.11 Salmonella

Salmonella should be absent in 25 g of selective plant fibers.

Proceed with counting according to the method described in Chapter II of the *International Oenological Codex*.

5.12 Bacteriological control

Proceed with counting according to the method described in Chapter II of the *International Oenological Codex*.

The total viable microorganism content should be less than $3 \cdot 10^4$ CFU/g.

5.13 Escherichia Coli

Proceed with counting according to the method described in Chapter II of the *International Oenological Codex*.

Absence should be checked on a 1-g sample.

5.14 Yeasts

Proceed with counting according to the method described in Chapter II of the *International Oenological Codex*.

Limit: 10^3 CFU/g of preparation.

5.15 Moulds

Proceed with counting according to the method described in Chapter II of the *International Oenological Codex*.

Limit: 10^3 CFU/g of preparation.

ANNEX 1

1. Method of analysis of insoluble parietal compounds (NDF fraction) according to the so-called 'crucible' method (Van Soest)**1.1 Principle**

Analysis of plant-cell-wall components (hemicellulose, cellulose and lignin) after solubilisation of proteins and starches by treatment with neutral detergent (ND).

1.2 Apparatus

1.2.1 Balance with precision of 0.001 g

1.2.2 Drying oven

1.2.3 Oven

1.2.4 Desiccator

1.2.5 Filter crucibles (40-100 µm porosity)

1.2.6 Fibertec-type (or equivalent) analyser, i.e. closed (semi-automatic / automatic) apparatus making it possible to treat up to 6 crucibles at the same time, including dispensing of reagents, extraction and its phases of boiling, rinsing and filtration.

1.3 Reagents

1.3.1 Heat-stable α -amylase, e.g. (Ref.: A3306) Sigma Chemical Co.

1.3.2 Neutral detergent solution (NDS); for 5 L solution:

- sodium lauryl sulphate ($\text{CH}_3(\text{CH}_2)_{11}\text{OSO}_3\text{Na}$, p. m.: 288.4) – 150 g,
- EDTA – disodium ethylenediaminetetraacetate ($\text{C}_{10}\text{H}_{14}\text{N}_2\text{Na}_2\text{O}_8 \cdot 2\text{H}_2\text{O}$, p. m.: 372.23) – 93.05 g,
- disodium tetraborate decahydrate ($\text{Na}_2\text{B}_4\text{O}_7 \cdot 10\text{H}_2\text{O}$, p. m.: 381.37) – 34.05 g,
- disodium hydrogen phosphate dihydrate ($\text{Na}_2\text{HPO}_4 \cdot 2\text{H}_2\text{O}$, p.m.: 177.99) – 22.8 g,

- triethylene glycol ($C_6H_{14}O_4$, p.m.: 150.17) – 50 mL.

1.4 Procedure

1.4.1 Insoluble fibers in the neutral detergent

- Prepare the crucibles.

For each sample of plant fibers, prepare 2 crucibles:

(A) Crucible for isolating insoluble components (NDF)

Weigh 2 g plant fibers in a clean, dry crucible.

Make a note of the weight with a precision of 0.001 g (W = weight of the sample).

(B) Crucible for measuring the ashes content of the sample

Weigh 1 g plant fibers in a clean, dry crucible.

Make a note of the weight with a precision of 0.001 g (W = weight of the sample).

- Insert the crucibles (into the Fibertec-type system).

Add 100 mL of NDS solution (1.3.2) to each sample at room temperature.

Add 50- μ l α -amylase (1.3.1).

Bring to and maintain at boiling point as follows:

heat for 5-10 minutes, until boiling; reduce the temperature and add an anti-foaming agent (such as octanoic acid) as it starts to boil; adjust the temperature to maintain boiling and continue to heat for 60 minutes.

After 1 hour of extraction, stop heating and remove the NDS solution using a suction system.

- Rinse and filter.

Add 40 mL hot water (90-100 °C) to each crucible, mix/stir the samples and leave to infuse for 2 minutes.

filter under vacuum.

Repeat this operation 4 times.

Add acetone to each crucible and leave to infuse for 2 minutes. Filter under vacuum.

Repeat this operation 2 times.

- Remove the crucibles.

Rinse crucible (A) twice with hot water (90-100 °C) and place at 105 °C for 12 hours.

Place crucible (B) at 105 °C for 12 hours, cool in the desiccator and weigh, which gives W1

(W1 = crucible + NDF fraction+ total ashes [TA]).

Then place it at 500 °C for 3 hours, cool in the desiccator and weigh, which gives W4

(W4 = crucible + total ashes [TA]).

1.4.2 Determination of the dry matter (DM) content

Weigh, with a precision of 0.001 g, a watch glass (W_{DM}).

Weigh, with a precision of 0.001 g, 2 g plant fibers in a clean and dry watch glass, which gives W2

(W2 = weight before drying).

Place the watch glass at 105 °C for 16 hours, leave to cool in the desiccator and weigh, which gives W3

(W3 = weight after drying).

1.5 Calculations

1.5.1 Determination of dry matter (DM)

$$\text{DM (\%)} = \frac{W3 - W_{DM}}{W2} \times 100$$

1.5.2 Determination of the insoluble fraction of fibers in the neutral detergent fiber (NDF)

$$\text{NDF} \begin{matrix} \text{(\%)} \end{matrix} = \frac{\begin{matrix} \text{(W1 -} \\ \text{W4)} \\ \text{\%} \end{matrix}}{\begin{matrix} \text{W} \\ \text{x} \\ \text{DM} \\ \text{100} \end{matrix}} \times 100$$

ANNEX 2

2. Measurement of the pesticide adsorption capacity by selective plant fibers**2.1 Principle**

The aim is to determine the adsorption capacity by selective plant fibers of a fungicide used for the treatment of vines, whose trade name is Boscalid.

IUPAC chemical name: 2-chloro-N-(4'-chlorobiphenyl-2-yl) nicotinamide

Chemical formula: C₁₈H₁₂CL₂N₂O

CAS No.: 188425-85-6

The proposed method refers to the determination of the Freundlich isotherm.

2.2 Safety precautions

Pesticides are potentially toxic and should be handled under safe conditions protecting the analysts, especially when preparing stock solutions from pure analytical standards. Operators should protect their hands and eyes, and work under an extraction hood.

2.3 Apparatus

- 2.3.1 Everyday laboratory glassware: calibrated flasks, pipettes, flasks
- 2.3.2 Balance with precision of 0.001 g
- 2.3.3 Magnetic stirrer
- 2.3.4 Centrifuge

2.4 Reagents

- 2.4.1 2-chloro-N-(4'-chlorobiphenyl-2-yl) nicotinamide analytical standard in powder form with a purity of > 99%
- 2.4.2 Quality acetone for residue analysis

2.4.3 Preparation of 2-chloro-N-(4'-chlorobiphenyl-2-yl) nicotinamide standard solutions:

2.4.3.1 - 1000-mg/L stock solution of 2-chloro-N-(4'-chlorobiphenyl-2-yl) nicotinamide in acetone: dissolve precisely 50 mg pure analytical-standard powder in 50 mL acetone. The stock solution may be kept at -20 °C for up to a year.

2.4.3.2 - 100-, 10- and 1-mg/L working solutions of 2-chloro-N-(4'-chlorobiphenyl-2-yl) nicotinamide in acetone: use successive dilutions of the stock solution in acetone. Working solutions may be kept at -20 °C for up to 6 months.

2.5 Procedure

A summary of the conditions used for the preparation of control wines and test wines is provided in Table 1 (see below).

2.5.1 Preparation of control wines

Prepare each control wine from a wine free from pesticides, adding 9 increasing concentrations of 2-chloro-N-(4'-chlorobiphenyl-2-yl) nicotinamide to the control in order to obtain, for example, 500 mL of each supplemented wine (see Table 1). Carry out the additions using the working standard solutions (2.4.3.2). Conduct 2 repetitions per concentration. 2-chloro-N-(4'-chlorobiphenyl-2-yl) nicotinamide is then analysed in the 9 control wines, in order to obtain the initial concentrations measured.

2.5.2 Preparation of test wines

Place the 9 wines supplemented with pesticide (2.5.1) in contact with the selective plant fiber.

Procedure:

Add 0.4 g selective plant fibers to a small volume of control wine supplemented with 2-chloro-N-(4'-chlorobiphenyl-2-yl) nicotinamide, then pour the mixture into a 200-mL calibrated flask and make up to 200 mL with this same wine (the dose of plant fiber is 2 g/L).

Leave this wine in contact with the plant fibers in a stoppered flask with the magnetic stirrer on for 45 minutes. Centrifuge for 5 minutes at

4500 rpm (3600 g). Separate the supernatant from the centrifugation pellet and proceed with the analysis of the 2-chloro-N-(4'-chlorobiphenyl-2-yl) nicotinamide residues in order to obtain the residual concentrations measured in the supernatant. Repeat this operation for the 9 control wines supplemented with 2-chloro-N-(4'-chlorobiphenyl-2-yl) nicotinamide (2.5.1). Conduct 2 repetitions per concentration.

Table 1: summary of the conditions for the determination of the capacity for adsorption of 2-chloro-N-(4'chlorobiphenyl-2-yl) nicotinamide

Contact time	45 minutes
Wine used for testing	Wine free from pesticides (prior analysis)
Selective plant fibers	Dose of 2 g/L (test wines) Absence (control wines)
Pesticide molecule tested	2-chloro-N-(4'chlorobiphenyl-2-yl) nicotinamide (common name: Boscalid)
Concentrations of 2-chloro-N-(4'chlorobiphenyl-2-yl) nicotinamide added	5 µg/L 15 µg/L 30 µg/L 60 µg/L 120 µg/L 240 µg/L 480 µg/L 960 µg/L 1500 µg/L
Number of repetitions	2
Centrifugation – parameters	Room temperature 4500 rpm (round 3600 g) for 5 minutes
Method of analysis of 2-chloro-N-(4'-chlorobiphenyl-2-yl) nicotinamide residue	Determination of pesticide residues in wine after extraction using the QuEChERS method (OIV-MA-AS323-08-type II), then analysis of the extracts by UPLC/MS/MS

2.6 Calculations

The determination of the capacity for adsorption of 2-chloro-N-(4'-chlorobiphenyl-2-yl) nicotinamide is calculated using the following Freundlich equation:

$$C_{Ads} = KF * C_{Res}^{1/n}$$

or its linear form: $\text{Log } C_{Ads} = 1/n \text{ Log } C_{Res} + \text{Log } KF$

where KF = the selective plant fiber's capacity for adsorption of the molecule in $\mu\text{g/g}$ of fiber,

n = the affinity of the selective plant fiber for the molecule,

- **CRes = the residual concentration** of chloro-N-(4'-chlorobiphenyl-2-yl) nicotinamide measured in the wine, in $\mu\text{g/mL}$, after contact with the selective plant fibers,
- **CAds = the concentration adsorbed** by the selective plant fibers, in $\mu\text{g/g}$:
 - o C_{Ads} in $\mu\text{g/g} = C_{Ads}$ in $\mu\text{g/L} / 2$ (where the adsorbent dose = 2 g fiber/L wine),
 - o **CAds in $\mu\text{g/L} = \text{the initial concentration}$** measured in the supplemented control wine, in $\mu\text{g/L}$, before contact with the selective plant fibers – **CRes in $\mu\text{g/L}$.**

Based on the residual concentrations ($\mu\text{g/L}$) measured, the concentrations of adsorbed 2-chloro-N-(4'-chlorobiphenyl-2-yl) nicotinamide ($\mu\text{g/L}$) are thus calculated for each initial concentration and the regression curve **$\text{Log } C_{Ads} = 1/n \text{ Log } C_{Res} + \text{Log } KF$** is traced.

The Freundlich adsorption regression of the pesticide by the selective plant fiber thus allows Freundlich's two constants to be calculated: the adsorption capacity in $\mu\text{g/g}$ (KF) and the affinity of the fiber for pesticide (n). The equation of the line $y = ax + b$ gives the slope $a = 1/n$ and $b = \text{Log } KF$.

E.g. Freundlich isotherm for 2-chloro-N-(4'-chlorobiphenyl-2-yl) nicotinamide

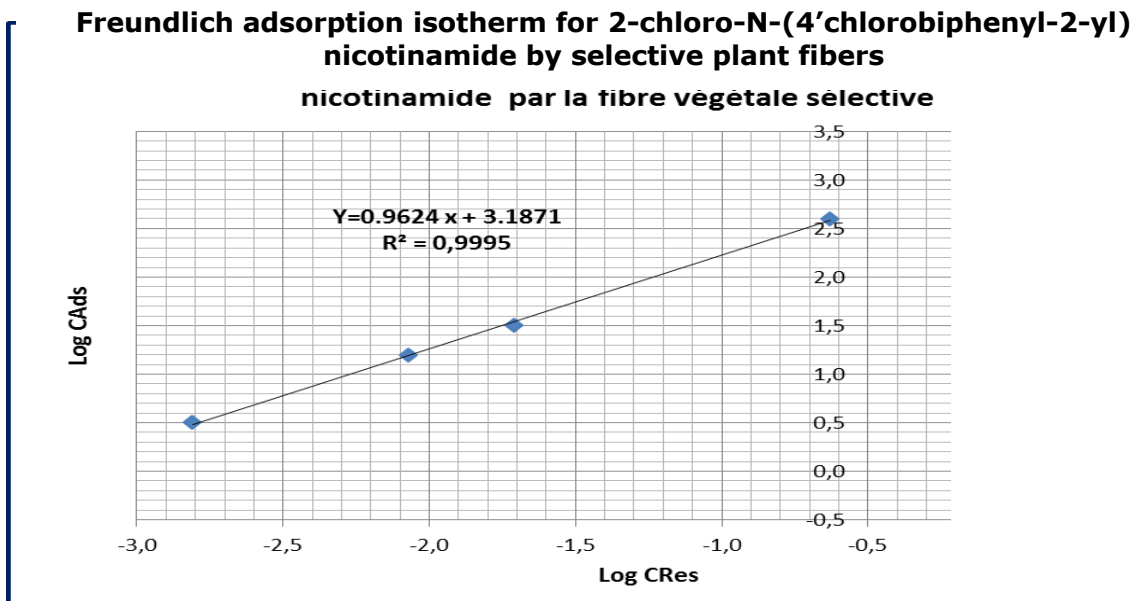

As such, in the below example, the following may be calculated:

$b = \text{Log KF} = 3.1871$, where $\text{KF} = 10^b = 1538.54$

$a = 1/n = 0.9624$, where $n = 1/a = 1.04$

The affinity (n) of the selective plant fiber for 2-chloro-N-(4'-chlorobiphenyl-2-yl) nicotinamide is 1.04 and the adsorption capacity (KF) of 2-chloro-N-(4'-chlorobiphenyl-2-yl) nicotinamide by the selective plant fibre is 1538.54 $\mu\text{g/g}$ or mg/kg of fiber.

ANNEX 3

3. Measurement of the ochratoxin A adsorption capacity by selective plant fibers**3.1 Principle**

The aim is to determine the adsorption capacity by selective plant fibers of a certain mycotoxin:

Commercial name: Ochratoxin A (OTA)

IUPAC chemical name: N-{[(3R)-5-chloro-8-hydroxy-3-methyl-1-oxo-3,4-dihydro-1H-isochromen-7-yl] carbonyl}-L-phenylalanine

Chemical formula: C₂₀H₁₈ClNO₆

CAS No.: 303-47-9

The proposed method refers to the determination of the Freundlich isotherm.

3.2 Safety precautions

Ochratoxin A is a toxin classified by the International Agency for Research on Cancer (IARC) as category 2B (possibly carcinogenic to human). It should therefore be handled under safe conditions protecting the analysts, especially when preparing stock solutions from pure analytical standards. Operators should protect their hands and eyes, and work under an extraction hood.

3.3 Apparatus

- 3.3.1 Everyday laboratory glassware: calibrated flasks, pipettes, flasks
- 3.3.2 Balance with precision of 0.001 g
- 3.3.3 Magnetic stirrer
- 3.3.4 Centrifuge

3.4 Reagents

3.4.1 Ochratoxin A (OTA) analytical standard in powder form with a purity of > 99%

3.4.2 Pure toluene, methanol and ethanol (HPLC quality)

3.4.3 0.1-mol/L sodium acetate buffer with pH 5.2: dissolve 13.061 g sodium acetate trihydrate into 900 mL of distilled water. Adjust the pH to 5.2 with acetic acid then make up to 1000 mL with distilled water.

3.4.4 Preparation of ochratoxin A standard solutions:

3.4.4.1- 50-mg/L stock solution in the toluene-acetic acid mixture: dissolve precisely 5 mg pure ochratoxin (3.4.1) in 100 mL toluene-acetic acid mixture (99:1, v/v). The stock solution may be kept at -20 °C for up to a year.

3.4.4.2 - 20 mg/L Working solution in methanol: evaporate, using a nitrogen flow, an aliquot portion (20 mL) of stock solution, then re-dissolve in 50 mL pure methanol. The working solution may be kept at -20 °C for up to 6 months.

3.4.4.3 - Addition solutions of 10, 5 and 2 mg/L in ethanol: conduct successive dilutions of the working solution in absolute ethanol. The addition solutions may be kept at -20 °C for up to 2 months.

3.5 Procedure

A summary of the conditions used for the preparation of control solutions and test solutions is provided in Table 2 (see below).

3.5.1 Preparation of control solutions

Prepare each control solution from a sodium acetate buffer solution with a pH of 5.2 (3.4.3), adding 9 increasing concentrations of ochratoxin A to the control in order to obtain, for example, 50 mL of each supplemented control solution (see Table 1). Carry out the additions using the addition solutions (3.4.4.3). Conduct 2 repetitions per concentration. Ochratoxin A is then analysed in the 9 control solutions in order to obtain the initial concentrations measured.

3.5.2 Preparation of test solutions

Place the 9 solutions supplemented with OTA (3.5.1) in contact with the selective plant fiber.

Procedure:

Add 0.05 g selective plant fibers to a small volume of acetate sodium buffer solution with a pH of 5.2 supplemented with OTA, then pour the mixture into a 25-mL calibrated flask and make up to 25 mL with this same buffer solution (the dose of plant fiber is 2 g/L). After 45 minutes of contact with the selective plant fibers while stirring, centrifuge the suspensions and separate the supernatant from the centrifugation pellet of fibers. Repeat this operation for the 9 control solutions supplemented with ochratoxin A (3.5.1). Ochratoxin A is then determined by HPLC, in order to obtain the residual concentrations measured in the supernatant. Conduct 2 repetitions per concentration.

Table 2: summary of the conditions for the determination of the capacity for adsorption of OTA

Contact time	45 minutes
Buffer used for testing	Sodium acetate (pH 5.2)
Selective plant fibres	Dose of 2 g/L (test solutions) Absence (control solutions)
Concentration of ochratoxin A added	2 µg/L 5 µg/L 20 µg/L 125 µg/L 450 µg/L 900 µg/L 2,000 µg/L 5,000 µg/L 10,000 µg/L
Number of repetitions	2
Centrifugation – parameters	Room temperature 10000 rpm (round 13000 g) for 2-3 minutes
Method of analysis of ochratoxin A	Determination of ochratoxin A in wine after going through an immunoaffinity column (OIV-MA-AS315-10), followed by analysis by HPLC with fluorometric detection

3.6 Calculations

The determination of the capacity for adsorption of ochratoxin A is calculated according to the following Freundlich equation:

$$CA_{\text{Ads}} = KF * C_{\text{Res}}^{1/n}$$

or its linear form: $\text{Log } CA_{\text{Ads}} = 1/n \text{ Log } C_{\text{Res}} + \text{Log } KF$

where KF = the selective plant fiber's capacity for adsorption of the molecule in $\mu\text{g/g}$ of fiber,

n = the affinity of the selective plant fiber for the molecule,

- **CRes = the residual concentration** of ochratoxin A measured in the test solution, in $\mu\text{g/mL}$, after contact with the selective plant fibers,
- **CA_{Ads} = the concentration adsorbed** by the selective plant fibers, in $\mu\text{g/g}$:
 - o CA_{Ads} in $\mu\text{g/g} = CA_{\text{Ads}}$ in $\mu\text{g/L} / 2$ (where the adsorbent dose = 2 g fibre/L buffer solution),
 - o **CA_{Ads} in $\mu\text{g/L}$ = the initial concentration** measured in the control solution, in $\mu\text{g/L}$, before contact with the selective plant fibers – **CRes in $\mu\text{g/L}$.**

Based on the residual concentrations ($\mu\text{g/L}$) measured, the concentrations of adsorbed ochratoxin A ($\mu\text{g/L}$) are thus calculated for each initial concentration and the regression curve **$\text{Log } CA_{\text{Ads}} = 1/n \text{ Log } C_{\text{Res}} + \text{Log } KF$** is traced. The Freundlich adsorption regression of ochratoxin A by the selective plant fiber thus allows Freundlich's two constants to be calculated: the adsorption capacity in $\mu\text{g/g}$ (KF) and the affinity of the fibre for ochratoxin A (n). The equation of the line $y = ax + b$ gives the slope $a = 1/n$ and $b = \text{Log } KF$.

E.g. Freundlich isotherm for ochratoxin A

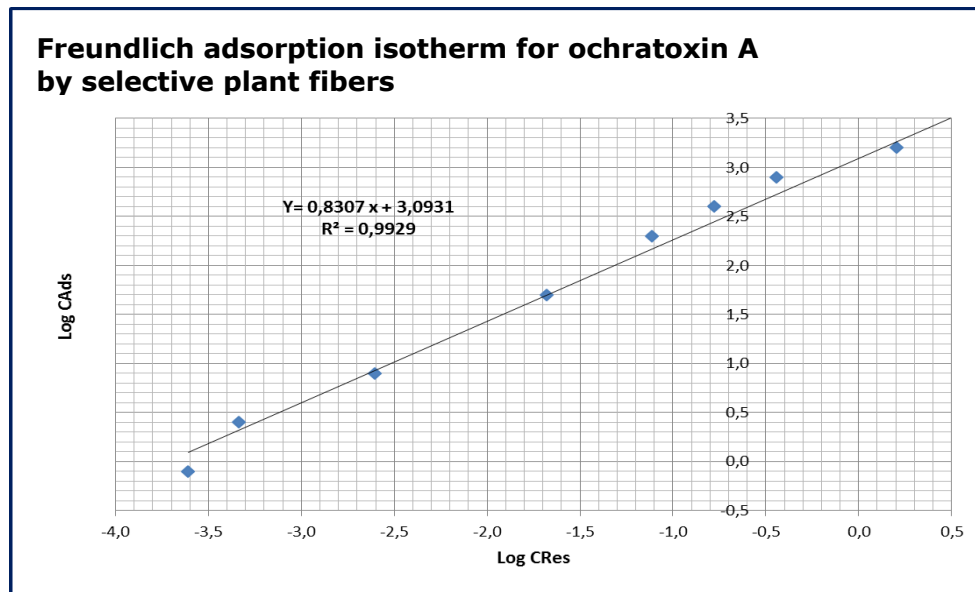

As such, in the below example, the following may be calculated:

$b = \text{Log KF} = 3.0931$, where $\text{KF} = 10^b = 1239.21$

$a = 1/n = 0.8307$, where $n = 1/a = 1.2$

The affinity (n) of the selective plant fiber for ochratoxin A is 1.2 and the adsorption capacity (KF) of ochratoxin A by the selective plant fiber is 1239.21 $\mu\text{g/g}$ or mg/kg fiber.

SORBIC ACID**Trans,trans-hexa-2-4-dienoic acid****CH₃-CH=CH-CH=CH-COOH****C₆H₈O₂ = 112.1****SIN NO. 200**

OENO 45/2000;

OENO 4/2007

1. OBJECTIVE, ORIGIN AND SCOPE OF APPLICATION

This product falls under the category of antifungal preservatives (see potassium sorbate). Because it is not soluble in wine, it cannot be used as is, but rather in its potassium salt form. It may be soluble in some spirits.

Its use is subject to regulatory restrictions on content.

2. LABELING

The label should indicate the product's purity and its safety and storage conditions.

3. SOLUBILITY

Water at 20 °C	1.6 g/l
Water at 100 °C	38 g/l
Alcohol	55 g/l
Ethyl ether	104 g/kg

This acid can be entrained in steam. At 100 °C, the steam has a sorbic acid concentration equal to 59% of the concentration of the dilute, boiling solution.

The ethyl ether/water partition coefficient is 32.

4. IDENTIFYING PROPERTIES

4.1. Melting point: 134 ± 2 °C. Boiling point: 228 °C.

4.2. Stir 20 mg of sorbic acid with 1 ml of brominated water (R). The color should disappear.

4.3. A solution containing 4 mg of sorbic acid per liter of water containing 0.5 g of monosodium carbonate per liter has an absorption band of 256 nm.

5. TESTS

5.1. Moisture

Not more than 0.5% of sorbic acid must be made up of water (Karl Fisher method).

5.2. Sulfuric Ash

The proportion of sulfuric ash is determined as indicated in the Annex. It should be less than 0.2 per 100.

5.3. Preparing the Solution for Tests

Shake 0.5 g of sorbic acid with 70 ml of boiling water. Let the solution cool. Filter and collect the filtrate in a 100 ml volumetric flask. Wash the first container and the precipitate and the filter several times with several ml of water until 100 ml of filtrate is obtained.

5.4. Sulfates

To 20 ml of solution prepared for tests under paragraph 5.3, add 1 ml hydrochloric acid diluted to 10 pp 100 (R) and 2 ml of barium chloride solution (R). The mixture should be clear, or the opalescence observed after 15 minutes should be less than that of the control solution prepared as indicated in the Annex. (Sulfate content expressed in terms of sulfuric acid should be less than 1 g/kg).

5.5. Chlorides

To 10 ml of solution prepared for tests under paragraph 5.3, add 5 ml of water, 5 ml of nitric acid diluted to 10 pp 100 (R) and 0.5 ml of 5 pp 100 silver nitrate solution (R). The mixture should be clear or the opalescence observed after 15 minutes should be less than that of the control solution prepared as indicated in the Annex. (Chloride content expressed in terms of hydrochloric acid should be less than 1 g/kg).

5.6. Heavy Metals

Take 10 ml of the solution prepared under paragraph 5.3. Add 2 ml of pH 3.5 (R) buffer solution, and 1.2 ml of thioacetamide reagent (R). Use the method described in the Annex. (Heavy metal content expressed in terms of lead should be less than 10 mg/kg).

5.7. Lead

Using the technique described in the Compendium, determine lead content in the test solution (5.3). (Lead content to be less than 2 mg/kg.)

5.8. Mercury

Using the technique described in the annex, determine mercury content in the test solution (5.3). (Content to be less than 1 mg/kg.)

5.9. Arsenic

Using the technique described in the annex, determine arsenic content in the test solution (5.3). (Content to be less than 3 mg/kg.)

5.10. Aldehydes

Prepare a saturate aqueous sorbic acid solution by agitating 1 g of sorbic acid with 35 ml of very hot water. Let cool in a corked flask. Filter and collect the filtrate in a 50 ml volumetric flask. Wash the flask, the precipitate and the filter several times with several ml of water until 50 ml of filtrate are obtained. Treat the solution with 0.5 ml of fuchsin solution bleached out with sulfuric acid (R). After 15 minutes, compare it to a control tube produced with 0.5 ml of the same reagent and 1 ml of formaldehyde in solution with 20 µg per ml. The resulting coloration should be less intense than that of the control. (Aldehyde content, expressed in terms of formaldehyde, should be less than 1 g/kg).

5.11. Quantitative Analyses

These analyses must be performed using sorbic acid which has previously been dried in a desiccation chamber with sulfuric acid for 24 hours.

1° Weigh a quantity **p** of sorbic acid of about 0.20 g and dissolve it in 10 ml of pure alcohol. Then dilute in 100 ml of water. Titrate the acidity using a 0.1M solution of sodium hydroxide in the presence of phenolphthalein solution (R). Let *n* be the amount in ml used:

1 ml of 0.1M sodium hydroxide solution corresponds to 0.0112 g of sorbic acid. Content in pp 100 of sorbic acid in the product tested:

$$1.12 \frac{n}{p}$$

2° The same procedure should be performed after entrainment in steam. Place 10 ml of the alcoholic solution containing a quantity of **p** grams of sorbic acid (about 0.2 g) in the bubble chamber of a steam distillation machine. Add a crystal (about 0.5 g) of tartaric acid and distill at least 250 ml (until the steam no longer distills acid). Titrate the distilled acidity using a 0.1M sodium hydroxide solution.

Using these two analyses, the product tested should contain at least 98 pp 100 sorbic acid.

6. STORAGE

Sorbic acid should be stored in hermetically sealed, airtight containers.

SKIM MILK
OENO 7/2008

1. OBJECT, ORIGIN AND FIELD OF APPLICATION

Skimmed cow's milk can be used to clarify wine. Its coagulation traps particles which are eliminated in the sediments. It must not introduce a taint into the wine.

The use of skimmed cow's milk may give rise to possible residual proteins in wine which may provoke a possible allergic reaction for some individuals.

Its use must comply with regulations in force for skim milk.

2. COMPOSITION AND LIMITS

Skim milk must comply with regulations in force concerning foodstuffs intended for human consumption.

ADSORBENT STYRENE-DIVINYLBENZENE BEADS**CAS No. 9003-69-4**

OIV-OENO 643-2020

1. OBJECT, ORIGIN AND SCOPE OF APPLICATION

The adsorbent beads enable the reduction or elimination of organoleptic deviations characterised as "earthy-musty" by a physical process of adsorption.

The adsorbent beads are placed in columns complying with food contact standards to enable the percolation of the must or wine in accordance with the files in the OIV *International Code of Oenological Practices*. They adsorb the unpleasant-smelling molecules whose dimensions are smaller than the size of their pores. The desired effect is achieved through the combination of the volume of the styrene-divinylbenzene copolymer beads determined by the size of the pores, and the speed the must or wine passes through the beads. Contrary to treatments of fruit juices with these same beads, the flow rates for this application are extremely rapid.

2. COMPOSITION

Adsorbent styrene-divinylbenzene beads should be manufactured according to good manufacturing practices from the following substances: styrene or ethenylbenzene or vinylbenzene (CAS No. 100-42-5) and divinylbenzene or diethenylbenzene (CAS No. 1321-74-0), which are approved substances for use in materials and articles intended to come into contact with foodstuffs. See '1. References'.

They are produced by the polymerisation of divinylbenzene (DVB) in the presence of styrene (or vinylbenzene), which functions as a cross-linking agent; the initial concentration of styrene may vary from 0.5% to 40% maximum.

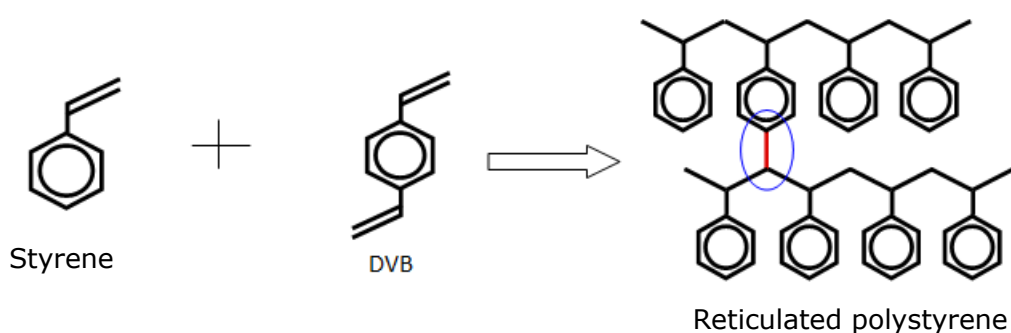

The cross-linked styrene-divinylbenzene copolymer is completely insoluble. In the majority of cases, it forms the structure of ion exchange resins or electro dialysis membranes before their grafting.

The adsorbent beads have a particle size of between 600 μm and 750 μm , and represent a specific surface area greater than or equal to 700 m^2/g , with pore diameters of between 1 nm and 40 nm maximum.

The inertia of the styrene-divinylbenzene copolymer beads should be satisfied.

Adsorbent beads should undergo pre-treatment or pre-conditioning with absolute ethanol (100% vol.) by the provider in order to eliminate residual monomers. They should be rinsed and conditioned before use, in accordance with the manufacturer's instructions.

3. LABELLING

The main characteristics should be indicated on the label, including the batch number, the expiry date and the storage conditions.

4. CHARACTERISTICS

They come in the form of odourless, porous, white beads. They are prepared and conditioned in wet form in 30-40% water, with the potential addition of sodium chloride, in order to prevent any drying out.

5. LIMITS AND TEST METHODS

5.1 General statements

Adsorbent styrene-divinylbenzene copolymer beads or non-grafted resins, used in the treatment of foodstuffs, should comply with the following requirements:

- They should not transfer any of their components into foodstuffs in quantities that could put human health at risk, or lead to an unacceptable modification of the composition of foodstuffs or an alteration of their organoleptic characteristics.
- The determination of the release of organic substances (determination of total organic carbon: TOC) and migration tests for specific components are carried out by the manufacturer using "food simulants" under "conventional migration test conditions". These tests are compulsory in order to obtain any authorisation for the commercialisation of resins or adsorbent styrene-divinylbenzene copolymer beads, or any food contact material.
- The application of adsorbent styrene-divinylbenzene copolymer beads in must or wine requires determining the migration of the specific components of the beads using 3 simulants. The determination of the migration of the specific components should be carried out using the following simulants: water, acetic acid at 3% (w/v) and ethanol at 20% vol. Additional concentrations may be tested for applications in specific products (e.g. liqueur wines).
- The contact time for the migration tests is 4 h, which is greatly superior to the contact time for the must or wine under treatment conditions, with this not exceeding several minutes.

5.2 Determination of Total Organic Carbon (TOC)**5.2.1 Control reagents**

- Distilled and/or deionised test water with conductivity of less than 20 $\mu\text{S}/\text{cm}$ at 25 °C and a TOC content of less than 0.2 mg/L.

5.2.2 Protocol

- Prepare 1 column and recover 100 mL test water from this column for a blank test (CB); the TOC content should be less than 0.5 mg/L,

- prepare 100 mL adsorbent beads, whose weight will have previously been determined,
- meanwhile, maintain the maximum temperature that can be reached during use (e.g. 20 °C),
- introduce 100 mL test water into the column, and progressively add the 100 mL of adsorbent beads that should be immersed; after sedimentation, use lateral tapping to create vibrations in the column and thus pack the resin in tightly to a constant volume,
 - percolate 2 L test water through the resin, at a flow rate of 1000 mL per hour,
 - maintain stagnation of the water for 24 hours,
 - collect 5 successive fractions of 100 mL test water having undergone percolation through 100 mL adsorbent beads at a flow rate of 500 mL/h,
 - analyse the TOC of the 5 fractions collected and of the blank test (CB) using an automatic TOC analyser.

5.2.3 Results

The sum of the results of the analyses of the TOC from each collection deducted from the value of the TOC from the blank test should not exceed 10 mg/L (acceptability criteria).

5.3. Migration testing of specific components: styrene and divinylbenzene

5.3.1 Objective

To verify that the profile of organic impurities or specific components of the adsorbent beads after pre-treatment by the manufacturer is compliant:

- a/ by estimating the total quantity of volatile organic impurities (styrene and divinylbenzene) present on the adsorbent beads,
- b/ by estimating the proportion of these impurities that may migrate into a solution with an extraction power (solvents or simulants) comparable to that of must and wine.

5.3.2 Solvents or simulants required

The following solvents are required:

- test water: distilled and/or deionised water with conductivity of less than 20 $\mu\text{S}/\text{cm}$ at 25 °C and a TOC content of less than 0.2 mg/L,
- ethanol at 20% vol. obtained from absolute ethanol and distilled and/or deionised water,
- acetic acid at 3% made up of a mixture of acetic acid and distilled and/or deionised water at the ratio of 3:97 (w/w).

5.3.3 Protocol

- Prepare 1 column per simulant and sample 100 mL test water from this column for a blank test,
- prepare 100 mL adsorbent beads, whose weight will have previously been determined,
- meanwhile, maintain the maximum temperature that can be reached during use (e.g. 20 °C),
- introduce 100 mL test water into each column, and progressively add the adsorbent beads that should be immersed up to a volume of 100 mL; after sedimentation, use lateral tapping to pack the resin in tightly to a constant volume,
- percolate 2 L of test water and of each solvent or simulant through the resins, at a flow rate of 1000 mL per hour,
- maintain stagnation for 4 hours,
- collect 5 successive fractions of 100 mL simulant having undergone percolation through 100 mL adsorbent beads at a flow rate of 500 mL/h,
- analyse the specific components of the 5 fractions collected from each simulant and from the test water, and of the blank test, according to the method described in Annex 1.
-

5.3.4 Results

The specific migration limits (SML) are those of the analytical limit of detection, i.e. for divinylbenzene, the SML = not detected (ND), considering that the LOD = 0.02 mg/kg.

6. USAGE LIMITS

- The treatment should not change the organoleptic characteristics of the wine.
- The treatment should not visibly modify the colour of the wine.
- The treatment should not significantly reduce the concentration of metallic cations in the wine.
- The treatment should not significantly modify the pH of the must or wine.
- The resin should not release substances into the wine or must that could alter it.

The reduction of the alcoholic strength of the wine should not exceed 0.1%.

The operator may use conditioning and/or regenerating agents composed of water and inorganic acids, bases or salts, on the condition that the conditioned or regenerated resin is rinsed in water until the conditioning and regenerating agents are completely eliminated, before the introduction of the must or wine.

7. DETERMINATION OF THE VOLUME OF ADSORBENT BEADS (BED VOLUME, BV) AND OF THE FLOW RATE OF THE MUST OR WINE TO BE TREATED (BV/H)

It is recommended that laboratory tests are performed to determine the quantities of beads and the flow rate to be applied and transposed to large-volume treatment.

7.1 Equipment

- Chromatography column, 10 mm in diameter and 250 mm in length, with 2 PTFE frits with a pore diameter of 50 µm at the ends,
- peristaltic pump,
- 5 L or 10 L must or wine contaminated with geosmin per test,
- adsorbent styrene-divinylbenzene copolymer beads.

7.2 Method

To determine the optimal flow rate for the elimination of geosmin (BV/h), apply the test on a volume of 5 or 10 mL beads (BV), which corresponds reciprocally to a 5- or 10-L volume of wine or must to be treated, so that the ratio of resin to the volume of wine or must to be treated is 1:1000. The optimal flow rate falls within the range of 150-250 BV/h.

The must to be treated should undergo prior degradation of its pectins and filtration, so that its turbidity is less than 10 NTU and the pores of the beads are thus not obstructed.

- Rinse the adsorbent beads well in water (osmosis water), then place in the column and tightly pack together by tapping on the column.
- Introduce the wine or must into the column using the peristaltic pump at a pre-determined flow rate. Check the output flow rate of the wine every 30 minutes using a graduated burette, to ensure there is no clogging of the resin. After treatment, check the free SO₂ and total SO₂, in order to readjust their content in the wine if needed.
- To verify that the treatment has no negative impact on the must or wine, carry out analyses on the 5 or 10 litres treated (Table 1).
-

-	Reds	Whites
Alcoholic strength	X in the wine	X in the wine
Residual sugars	X in the wine	X in the wine
Total sugars	X in the must	X in the must
Volatile acidity	X	X
Total acidity	X	X
pH	X	X
Free and total SO ₂	X	X
OD 280 nm	X	X
OD 320 nm	X	X
OD 420 nm or CIELAB	X	X
OD 520 nm or CIELAB	X	
OD 620 nm or CIELAB	X	

Table 1: Analyses to be carried out before and after treatment

The quantity of adsorbent beads and the flow rate will be readjusted, either according to the rate of elimination of geosmin demonstrated by analysis (SPME-GC-MS method, which is the internal method of COFRAC-accredited laboratories), or, if the treatment is urgent, by a simple tasting confirmed later by analysis.

8. REGENERATION

The adsorbent beads may be regenerated a maximum of 5 times, after the total or partial volume of must or wine has passed through.

Regeneration is carried out in the column by passing through a 4M sodium hydroxide solution with the slowest possible flow rate depending on the type of pump (e.g. 20 BV/h).

Rinsing is performed with drinking water of a known pH (initial pH), until the sodium hydroxide has been eliminated; this is controlled through measurement of the pH of the water used for rinsing, which should be identical to the initial pH.

9. CONDITIONS OF USE

Storage, use and regeneration of the adsorbent beads, and their disposal as waste, should be carried out according to the techniques permitted for food contact materials. The manufacturer is required to provide all necessary information for their use and regeneration. According to the legislation in force, the adsorbent beads are to be disposed of in approved industrial waste treatment centres for recycling, specifically through depolymerisation.

10. REFERENCES

- Regulation (EC) No. 1935/2004
- Regulation (EU) No. 10/2011, amended, Annex 1, Table 1
- FDA regulations as found in Title 21 of the Code of Federal Regulations (CFR), Part 173 – Secondary Direct Food Additives permitted in food for human consumption, §173.65

Annex 1**Determination of styrene and divinylbenzene in wines
(Type IV Method)****Important notice**

The user of this publication should be well aware of current laboratory practices. This publication is not intended to address any safety problems that may be related to its use. The user is responsible for establishing the appropriate health and safety practices, and ensuring respect for both the national regulations in force and the environment.

Scope of application

TESTING OF MIGRATION OF SPECIFIC COMPONENTS

Objective

To verify that the profile of organic impurities or specific components of the adsorbent beads after pre-treatment by the manufacturer is compliant.

- a/ By estimating the total quantity of volatile organic impurities present on the adsorbent beads;
- b/ by estimating the proportion of these impurities that may migrate into a solution with an extraction power (solvents or simulants) comparable to that of must and wine.

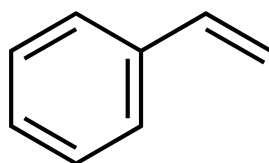

Styrene

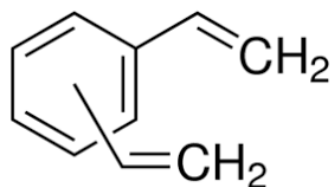

DIVINYLBENZENE

Divinylbenzene exists in 3 forms: ortho, meta and para.

Standard references

ISO 78-2: Chemistry – Layouts for standards

Principle of the method

The method is gas chromatography coupled to mass spectrometry. The sample is extracted in the headspace using the solid-phase microextraction (SPME) technique. The wine/must sample is prepared by adding, to an SPME vial, roughly 2 g NaCl with 10 mL wine/must and 50 µL ethyl

heptanoate solution (internal standard) solution at 20 mg/L. The vial is sealed and stirred for 5 minutes. The internal standard used here is given by way of example; it is possible to use other internal standards. For the measurement, six calibration points are used based on a stock solution containing all of the molecules to be studied.

1. Reagents and working solutions

During analysis – unless otherwise indicated – use only quality, recognised analytical reagents and distilled or demineralised water, or water of equivalent purity.

Reagents

- Type I or Type II water for analytical usage (ISO 3696 standard)
- Ethanol (CAS No. 64-17-5)
- Sodium chloride (CAS No. 7647-14-5)
- Ethyl heptanoate (CAS No. 106-30-9)
- Divinylbenzene (CAS No. 1321-74-0)
- Styrene (CAS No. 100-42-5)

Working solutions

Individual stock solutions at 1 g/L are prepared in ethanol for each molecule as well as for the internal standard (ethyl heptanoate).

Based on the individual stock solutions, working solutions are prepared with ethanol to the desired concentrations so as to cover the whole measurement range.

Calibration solutions

In order to ensure traceability to the International System of Units (SI), the calibration range should be made up of solutions with 12% (v/v) ethanol (5.1.2) covering 6 points of the range of measurement ($1-100 \mu\text{g}\cdot\text{L}^{-1}$). These solutions are prepared at the time of analysis for single use.

The calibration equation obtained is a second-degree equation.

Apparatus

The apparatus is given by way of example. The GC-MS technique used allows for the necessary variations or optimisations to be made according to the equipment configuration.

- GC-MS equipped with a "split-splitless" injector and mass-spectrometer detector
- Capillary column with apolar stationary phase, 5% phenylmethylpolysiloxane (e.g. HP-5MS, 30 m x 0.25 mm x 0.25 μm film) or equivalent
- Calibrated 100- μL , 1- μL and 10- μL microsyringes
- 20-mL SPME vial, sealable by a perforated capsule and Teflon®-faced cap
- Solid-phase microextraction system (SPME) with polydimethylsiloxane-film-coated fibre of 100 μm in thickness
- Balance
This should have 0.1 mg precision.
- Measuring glassware

The measuring glassware for the preparation of reagents and calibration solutions is class A.

Preparation of samples

Test samples

Place 10 mL wine/must in a 20-mL SPME glass vial (6.4) with roughly 2 g NaCl (5.1.3) and 50 µL ethyl heptanoate (internal standard) at 20 mg/L (5.1.4).

Seal the vial with a perforated cap and Teflon® seal (6.4).

GC-MS Procedure**Extraction**

Carry out headspace SPME extraction for 25 minutes at room temperature.

Injection

Carry out desorption from the fibre for 10 minutes in the injector.

Injector at 260 °C in splitless mode

Helium flow rate: 2mL/min

Gas chromatography parameters

Column: 5MS UI 30 m x 0.25 mm x 0.25 µm

Transfer line: 300 °C

Oven: 45 °C

Then 2 °C/min up to 80 °C

Then 3 °C/min up to 92 °C

Then 40 °C/min up to 300 °C

Then 300 °C for 2 minutes

Run time: 28.7 minutes

Acquisition

Source temperature: 230 °C

Quad temperature: 150 °C

Acquisition: SIM

	Run time (min)	Ions (quantified)	Ions (qualified)
Ethyl heptanoate	15.0	88	113 / 101 / 158
Styrene	5.0	104	78 / 103 / 50
m,p-Divinylbenzene	15.4 & 16.1	130	128 / 115

Results

Example chromatogram and calibration curve for styrene

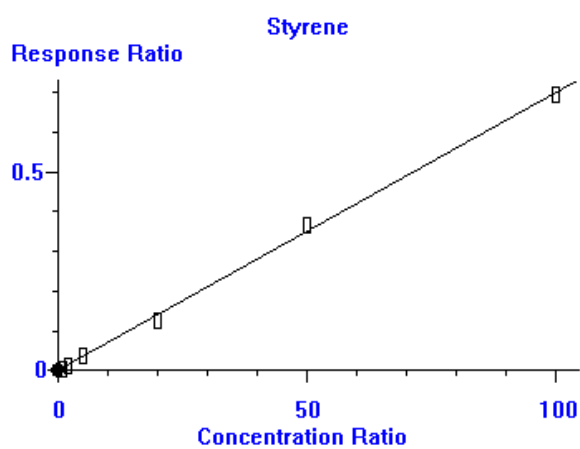

Example chromatogram and calibration curve for divinylbenzene

Expression of results

The results are expressed in $\mu\text{g/L}$.

THIAMINE HYDROCHLORIDE
3-[(4-amino-2-methyl-5-pyrimidinyl)methyl-5-
(2-hydroxyethyl-4-methylthiazolium hydrochloride
Thiamini hydrochloridum
C₁₂H₁₈Cl₂N₄OS = 337.3
OENO 50/2000

1. OBJECTIVE, ORIGIN AND SCOPE OF APPLICATION

This product is used to promote alcohol fermentation. Its use is subject to statutory restrictions placed on limiting thiamine content.

2. LABELING

The label should indicate the purity percentage of the product, the use-by date, and the safety and storage requirements.

3. PROPERTIES

White or substantially white crystalline powder or colorless crystals with a slight characteristic odor. Easily soluble in water, soluble in glycerol, minimally soluble in alcohol, virtually insoluble in chloroform and ethyl ether.

4. SOLUBILITY

Water at 20 °C	1000 g/l
Alcohol, 95% by vol.	12.5 g/l
Glycerol	63.3 g/l
Ethyl ether,	insoluble

5. PROOF

Proof test **5.1** may be omitted when tests **5.2** and **5.3** are performed. Proof test **5.2** may be omitted when tests **5.1** and **5.3** are performed (methods described in the Annex).

5.1. Examine the thiamine hydrochloride by absorption spectrophotometry in infrared light.

The maximum absorption values of the spectrum obtained from the substance tested correspond, in position and relative intensity, to those obtained from thiamine hydrochloride SCR. If the spectra exhibit differences, dissolve the substance to be tested and the chemical reference substance, respectively, in water. Evaporate the solutions until dry and produce new spectra from the resulting residues.

5.2. Dissolve about 20 mg thiamine hydrochloride in 10 ml of water. Add 1 ml dilute acetic acid (R) and 1.6 ml of 1M sodium hydroxide (R). Heat in a 100 °C water bath for 30 minutes and let cool. Add 5 ml of dilute sodium hydroxide solution (R), 10 ml potassium hexacyanoferrate (III) solution (R) and 10 ml of butanol. Shake vigorously for 2 minutes. An intense light blue fluorescence will spread in the alcoholic layer, especially ultraviolet light at 365 nm. Repeat the test using 0.9 ml 1M sodium hydroxide and 0.2 g sodium sulfite replacing the 1.6 ml 1M sodium hydroxide. Virtually no fluorescence will be observed.

5.3. Thiamine hydrochloride produces chloride reactions (method described in the Annex).

5.4. Thiamine hydrochloride contains at least 98.5 pp 100, and at most the equivalent of 101.5 pp 100, 3-[(4-amino-2-methyl-5-pyrimidinyl)methyl]-5-(2-hydroxyethyl)-4-methylthiazolium hydrochloride, as calculated with respect to the anhydrous substance.

6. TESTS

6.1. Desiccation Loss

Place 2 g of thiamine in an oven at 105 °C for 3 hours. Weight loss should not be greater than 5 pp 100.

6.2. Sulfur Ash

Using the method described in the annex, analyze 2 g thiamine hydrochloride. The sulfur ash content should not be greater than 0.1 pp 100.

6.3. Preparing the Solution for Tests

Dissolve 5 g thiamine hydrochloride in water and fill to 100 ml.

6.4. Determining pH

The pH of the solution prepared for tests under Paragraph 5.3 and diluted by one-half should have a pH of between 2.7 and 3.3.

6.5. Nitrates

Add 1 ml water and 1 ml concentrated sulfuric acid (R) to 1 ml of the solution prepared for tests under Paragraph 5.3. Cool. Deposit 2 ml of the extemporaneously prepared 5 pp 100 iron (II) sulfate solution on the surface of the liquid. No brown ring should form at the interface of the 2 layers.

6.6. Heavy Metals

Test for heavy metals in 10 ml of the solution prepared for tests under Paragraph 5.3 using the method described in the Annex. (Heavy metal content expressed in terms of lead should be less than 10 mg/kg).

6.7. Lead

Using the method indicated in the annex, determine lead content in the test solution (5.3). (Lead content should be less than 5 mg/kg).

6.8. Mercury

Using the method indicated in the Annex, determine the mercury content in the test solution (5.3). (Mercury content should be less than 1 mg/kg).

6.9. Arsenic

Using the method indicated in the Annex, determine the arsenic content in the test splution (5.3). (Arsenic content should be less than 3 mg/kg).

7. QUANTITATIVE ANALYSIS

Dissolve 0.150 g of thiamine hydrochloride in 5 ml anhydrous formic acid. Add 65 ml anhydrous acetic acid, then, while stirring, 10 ml mercuric acetate solution. Quantitatively analyze organic base halogenated salts in a non-aqueous medium by titrating with 0.1M perchloric acid. Determine the point of equivalence by potentiometric analysis. 1 ml of 0.1M perchloric acid corresponds to 16.86 mg of $C_{12}H_{18}Cl_2N_4OS$.

8. STORAGE

Thiamine hydrochloride should be stored in properly sealed, non-metal containers kept away from light.

ULTRAFILTRATION MEMBRANES

OIV-OENO 481-2013

1. OBJECT, ORIGIN AND SCOPE OF APPLICATION

Membranes belonging to the family of porous membranes, these can be organic or inorganic, and are generally anisotropic (asymmetric) or composite membranes; they may have a spiralled or "spiral-wound", flat sheet or "frame and plate", tubular or hollow fibre configuration.

Ultrafiltration is a physical separation process which is applied to the separation of particles ranging from 0.001 to 0.1 µm with retention of macromolecules and colloidal aggregates.

Ultrafiltration membranes are characterised by the retention of standard macromolecules with known molar masses. The cut-off threshold (or MWCO for molecular weight cut-off) is defined as the molar mass of a macromolecule from the standard range that would be retained at 90 or 95%.

The active layer of the ultrafiltration membranes consists of organic or inorganic material that has a microporous structure with pore diameters of about one nanometre.

2. PROCEDURE PRINCIPLE

This is a physical filtration method allowing the particles and macromolecules in the must or wine to be retained using a semi-permeable membrane driven by a pressure gradient at ambient temperature.

The process is carried out as a tangential flow. The apparatus mainly consists of what is called a "booster" pump feeding a circulation pump between 2 and 10 bars, a membrane block and monitoring equipment, such as a flowmeter, pressure indicator and controller, etc.

3. COMPOSITION

All the equipment used in the procedure conforms with regulations relating to equipment in contact with food (pipes, pumps, monitoring equipment, joints, etc.).

These membranes are usually prepared through *in situ* polymerisation of a polymer on the surface of a porous substrate. The thin layer serves as

the discriminating membrane, while the porous substrate acts as the physical support.

Examples of the main organic polymers used may include cellulose acetate, polyacrylonitrile, polyamide, polysulfone, polyimide, etc.

Mineral membranes are usually the composite materials, since the support is different from the active layer. They only exist as flat or tubular membranes. For the supports, ceramics make up the majority of membranes, but porous carbon and metal oxides may also be used. Active layers are often comprised of aluminium oxide, zirconium dioxide or titanium dioxide (in the case of ceramics).

4. LABELLING

The main characteristics should be indicated on the label, particularly the batch number.

5. MANUFACTURE

Through a number of procedures, it is possible to obtain a whole range of pore sizes (from MFT to the dense membrane of RO).

The final characteristics (thickness, porosity, pore size, internal structure) of the membrane depend on a great number of parameters (choice of ternary solvent/polymer/non-solvent, composition of collodion, addition of porogenes, operating conditions - temperature, casting speed, diameter/thickness of the collodion, etc.)

For mineral membranes, the active layer is generally obtained by the sol-gel method, then laid on the solid support. The final step is sintering (between 400 and 1200 °C) which is used to adjust the average diameter of the pores of the membrane from the grain size of the initial powder.

6. MEMBRANE CLEANING

The user may use inorganic products authorised according to regulations, provided that the operation ends by rinsing with water so as to completely remove the cleaning product before adding the must or wine.

7. LIMITS

- All the equipment in contact with food products must comply with the standards in force.
 - There should be no noticeable change in the organoleptic characteristics of the must.
- Any potential release of the product or derivative comprising the membrane must comply with the current specific migration standards for the various constituents of the equipment.

8. SPECIAL RESTRICTIONS

The membrane must meet the regulatory requirements for equipment in contact with food.

PIECES OF OAK WOOD

OENO 3/2005;
OIV/OENO 430/2010;
OIV-OENO 406/2011

1. OBJECT, ORIGIN AND FIELD OF APPLICATION

Pieces of oak wood used for winemaking and for passing on certain constituents to the wine in conditions set by regulations.

The pieces of oak wood must come exclusively from the *Quercus* genus.

They can possibly be left in their natural state or they can be heated to a low, medium or high temperature but they must not be charred including on the surface, nor be carbonaceous, nor friable when touched.

No compound should be added to them for the purpose of increasing their natural aromatising capacity or their extractible phenolic compounds.

Likewise, they must not undergo any chemical, enzymatic or physical treatment other than heating.

2. LABELLING

The label must mention the varietal origin of the oak and the intensity of any heating, the storage conditions and safety precautions.

3. DIMENSIONS

The dimensions of these particles must be such that at least 95% in weight be retained by the screen of 2 mm mesh (9 mesh).

4. PURITY

The pieces of oak wood must not release any substances in concentrations which may be harmful to health,

5. STORAGE CONDITIONS

The pieces of oak wood must be stored in sufficiently dry and odourless conditions free from substances liable to contaminate them.

6. INTRODUCTION IN WINE

Where bags or other containers are used as the means of introducing pieces of oak wood or related support system into wine, they must be made from materials that are approved for food contact in the country of use, and which do not release any substances into the wine in concentrations which may be harmful to health, or jeopardise to the quality of the final product.

ANNEXE A

Determination of the size of pieces of oak wood by screening
(Oeno 406-2011)

1. Introduction

The use of pieces of oak wood, commonly called chips, to treat wine is authorised provided they comply with the specifications of the Oenological Codex (resolution OENO 3/2005). In particular, the pieces of oak wood used must meet a size requirement, and it is specified that "The dimensions of these particles must be such that at least 95% in weight be retained by the screen of 2 mm mesh (9 mesh)". The following operating procedure provides a method of sampling and then screening that can be used to verify this requirement.

2. Field of application

The method applies to oak wood test samples of more than 0.5 kg.

3. Principle

After dividing up the initial test sample, a known quantity of pieces of oak wood (approximately 200g) is placed on a vibrating screen. By weighing the pieces of oak wood remaining on the screen after shaking, it is possible to determine the percentage by weight of particles retained by the screen.

4. Equipment

- Standard laboratory equipment.
- Screen of 2 mm mesh (9 mesh), 30 cm in diameter, mounted on a vibrating plate provided with a recovery tray.
- Weighing machine capable of weighing to within 0.1 g.
 - Slotted test specimen divider (see figure below as an example).

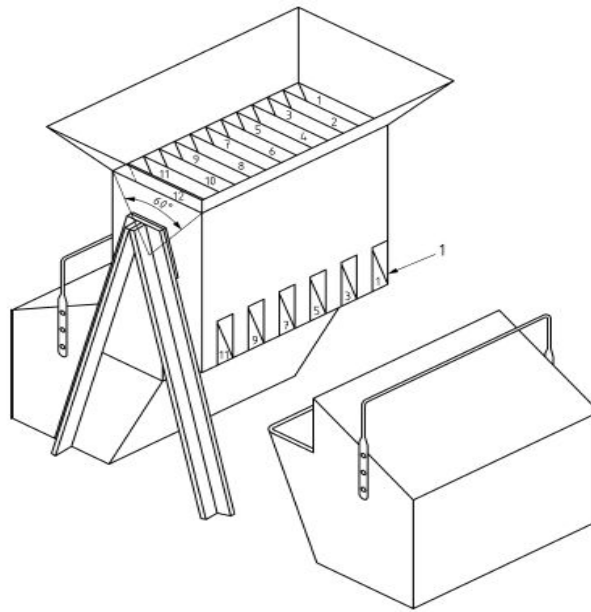

1 Alternating sections on
either side

échantillons à fentes

Slotted test sample divider (EN 1482-1: 2007)
Scheme proposed as an example

5. Division of test sample

When the size of the test sample has to be reduced to obtain "sub-samples" of 200 g which retain a homogeneous nature representative of the initial test sample, a slotted test sample divider can be used which allows random separation of the test sample into 2 parts.

The test sample is poured entirely into the divider in order to separate it into two statistically equivalent parts. Half is put aside, while the other half is again split by means of the chip spreader. This operation is repeated as often as necessary, half being eliminated at each stage with the aim of obtaining 2 "sub-samples" of about 200 g each.

6. Operating procedure

- Weigh the empty screen (W_{ES}).
- Weigh the empty recovery tray (W_{ET}).
- Tare the screen + recovery tray unit and place on it about 200 g of pieces of oak wood weighed to within 0.1 g. Let W_{OAK} be the weight of the pieces of oak wood to be screened.
- Place the unit on the vibrating plate and close the cover with the clamping loops.
- Start up the device and allow it to vibrate for 15 minutes.
- Weigh the screen containing the remaining particles that have not passed through the 2mm meshes (W_{PS}).
- Weigh the recovery tray containing the particles that have passed through the screen (W_{PT}).

A second test is performed in these conditions on the second sub-sample of pieces of oak wood coming from the same initial test sample.

Comment: Weighing of the recovery tray before and after screening (W_{RT} and W_{PT}) serves to verify that there has been no loss of test sample during the operation.

One should have: $W_{ES} + W_{ET} + W_{OAK} = W_{PS} + W_{PT}$

7. Calculation

The percentage (by weight) of particles retained by the screen of 2mm mesh is given by the following formula:

$$\% \text{ of particles retained} = \frac{(W_{PS} - W_{ES}) \times 100}{W_{OAK}}$$

This calculation is performed for each of the 2 sub-samples coming from the initial test sample; the percentage of particles retained corresponds to the mean of the 2 results.

8. Bibliography

Resolution OENO 3/2005 PIECES OF OAK WOOD
EN1482-1 - Fertilizers and liming materials. Sampling and sample preparation. Part 1: Sampling.

WOOD FOR WINE CONTAINERS

OENO 4/2005

1. SUBJECT, ORIGIN AND SCOPE

The wood of containers used during the making, storage or transport of wines.

The pieces of wood must exclusively originate from species recognized as being suitable to store wine (oak, chestnut)

They can possibly be left in their natural state or they can be heated to a low, medium or high temperature, but they must not be charred, including on the surface, nor be carbonaceous, nor friable when touched.

No compound should be added to them for the purpose of increasing their natural aromatizing capacity or their extractable phenolic compounds.

They must not undergo any chemical, enzymatic or physical treatment other than heating when used for new containers.

If they have undergone chemical or physical treatment, in particular to clean containers having already been used, it is recommended to ensure the perfect harmlessness of any such treatment for materials in contact with foodstuffs, and in particular to ensure that sufficient rinsing has eliminated any trace of certain products that are not authorized in wine.

2. CONTAINER MARKING AND/OR ACCOMPANYING DOCUMENT

Container markings or the accompanying document must indicate the origin of the botanical species of wood, the intensity of any heating and the safety instructions.

3. PURITY

Wooden containers must not release substances in concentrations which may be harmful to health.

4. STORAGE

Wooden containers must be washed before first use and then stored under suitable conditions to prevent any development of undesirable micro-organisms when the containers are empty.

***Saccharomyces* spp. selected yeasts**

OIV-OENO 567A-2017

1. OBJECT, ORIGIN AND FIELD OF APPLICATION

Saccharomyces spp. selected yeasts can be used for the inoculation of grapes, musts and wine according to resolution OENO-MICRO 14-546 in order to initiate and/or ensure completion of alcoholic fermentation and the production of special wines.

Yeasts used must be isolated from grapes, musts or wine or result from hybridisation of grape/must/wine strains, or have been derived from other wine yeasts. Prior to the use of genetically modified oenological yeasts, authorisation by competent authorities is required.

2. LABELLING

The following information must be indicated on the packaging:

- the genus name (*Saccharomyces*), the species name, the name of the strain(s) and all elements that can guarantee the traceability of the product,
- the physical form of the products as described in point 3,
- the name of the selector,
- the name and contact address of the manufacturer or marketer or distributor,
- operating instructions recommended by the manufacturer,
- a recommended rate of inoculation,
- the minimum number of viable cells per gram of product (CFU as determined in 4.6) guaranteed by the manufacturer, with a recommended storage temperature,
- the manufacturing batch number, the expiration date and storage conditions,
- where relevant, the indication that the yeast strain(s) were obtained through genetic modifications and their modified character(s),
- all additives present.

3. CHARACTERISTICS

The formulation is a pure culture or a blend of strains of *Saccharomyces* or a blend of *Saccharomyces* and non-*Saccharomyces*.

Saccharomyces selected yeasts can be used in the following forms:

- Active Dry Yeast (ADY) with a minimum dry matter of 92% and a level of viable yeasts equal or above to 10^{10} CFU/g of dry matter,
- Active Frozen Yeast (AFY) with a range of dry matter from 40 to 85% and a level of viable yeasts equal to or above 10^{10} CFU/g of dry matter,
- Compressed Yeast (COY) with a range of dry matter from 30 to 35% and a level of viable yeasts equal to or above 10^{10} CFU/g of dry matter,
- Cream Yeast (CRY) with a range of dry matter from 18 to 25% and a level of viable yeasts equal to or above 10^{10} CFU/g of dry matter,
- Encapsulated (beads) or Immobilised Yeasts (ENY) with alginate and/or other products admitted by the OIV, with a minimum of dry matter of 86% and a level of viable yeasts equal to or above 10^9 CFU/g of dry matter,
- "levain de tirage" for sparkling wines containing above 50×10^6 of viable cells per mL.

4. LIMITS AND METHODS OF ANALYSIS

4.1 - Humidity

Measured by the weight loss of 5 g of product dried at 105 °C until it reaches a constant weight. Content should satisfy the characteristics of humidity or water level described in point 3.

4.2 - Lead

Proceed with the determination according to the method in Chapter II of the *International Oenological Codex*.

Content should be less than 2 mg/kg of the suitable preparation described in point 3.

4.3 - Mercury

Proceed with the determination according to the method in Chapter II of the *International Oenological Codex*.

Content should be less than 1 mg/kg of the suitable preparation described in point 3.

4.4 - Arsenic

Proceed with the determination according to the method in Chapter II of the *International Oenological Codex*.

Content should be less than 3 mg/kg of the suitable preparation described in point 3.

4.5 - Cadmium

Proceed with the determination according to the method in Chapter II of the *International Oenological Codex*.

Content should be less than 1 mg/kg of the suitable preparation described in point 3.

4.6 - Total viable yeasts

Proceed with counting according to the method in Chapter II of the *International Oenological Codex*. Content should comply with the characteristics described in point 3.

4.7 - Yeasts other than those indicated on the label

Proceed with counting according to the method in Chapter II of the *International Oenological Codex*, in order to obtain colonies for further identification.

4.7a. Determination of a contaminant based on the genus: a contaminant population of a different genus to *Saccharomyces* should be 5 logs less than the total population of strains indicated on the label, and defined in the characteristics described in point 3. Proceed with counting according to the method described in Chapter II of the *International Oenological Codex* to distinguish between *Saccharomyces* and non-*Saccharomyces*.

4.7b. Determination of a contaminant based on the species or strain: the species and strains indicated on the packaging should account for at least 95% of the total yeast population. Proceed with control according to Annex 1.

4.8 - Moulds

Proceed with counting according to the method in Chapter II of the *International Oenological Codex*.

Content should be less than 10^3 CFU/g of the suitable preparation described in point 3.

4.9 - Lactic acid bacteria

Proceed with counting according to the method in Chapter II of the *International Oenological Codex*.

Content should be less than 10^5 CFU/g of the suitable preparation described in point 3.

4.10 - Acetic acid bacteria

Proceed with counting according to the method in Chapter II of the *International Oenological Codex*.

Content should be less than 10^4 CFU/g of the suitable preparation described in point 3.

4.11 - Salmonella

Proceed with counting according to the method in Chapter II of the *International Oenological Codex*.

Absence should be checked on a 25 g sample.

4.12 - Escherichia coli

Proceed with counting according to the method in Chapter II of the *International Oenological Codex* using the selective differential medium for *Escherichia coli*.

Absence should be checked on a 1 g sample.

4.13 - Staphylococci

Proceed with counting according to the method in Chapter II of the *International Oenological Codex*. The presence of staphylococci is evaluated by an enrichment culture in a liquid Giolitti and Cantoni medium followed by a confirmation on a solid Baird Parker medium.

In the case that the Giolitti and Cantoni medium gives positive results, the presence of Staphylococci is confirmed by isolation on a solid Baird Parker medium. A positive culture medium loop is used to inoculate solid BP mediums to obtain isolated colonies.

Absence should be checked on a 1 g sample.

4.14 - Coliforms

Proceed with counting according to the method in Chapter II of the *International Oenological Codex* using a selective differential medium for coliforms, desoxycholate gelose.

Number should be less than 10^2 CFU/g of the suitable preparation described in point 3.

5. ADDITIVES

These must conform with regulations in force.

6. STORAGE CONDITIONS

Products must be stored and propagated under conditions which favour their genetic stability.

Refer to manufacturer's recommendations.

7. PRODUCT DOCUMENTATION

Product documentation should specify guidelines about storage, transportation, handling and application conditions (temperature, activation, rehydration when needed, possibly in suitable must or wine suspensions, etc.).

ANNEX 1

1 Obtention of colonies

Sample 1 g or 1 mL in case of "levain de tirage", and suspend it under sterile conditions in 100mL sterile saccharose 5%. Homogenise and allow standing at 25-30 °C for 20min.

After adequate serial decimal dilutions, spread 0.1mL of the diluted sample onto the surface of a nutrient YEPD agar plate (Glucose 20 g, Peptone 20 g, Yeast extract 10 g, 100 mg chloramphenicol to avoid bacterial growth and 150mg biphenyl to avoid mould growth, Agar-agar 20 g, Water q.s.p. 1000 mL). Incubate for 6 days at 25 °C in aerobiosis. All yeast can grow even non-*Saccharomyces* that would contaminate or be part of the blend with *Saccharomyces* spp. in the preparation.

2 Identification of contaminant species/strains

Identification is carried out on the colonies isolated on plates.

As indicated in the characteristics, the contaminant population (which is neither the pure strain nor the different strains in case of mixed strains)

should be less than 5% of the total population. After the dilutions needed to obtain individual colonies, if 20 colonies out of 300 are identified, a contaminant at 5% (ideally) should represent 1 colony out of 20.

The contaminant is identified based on the species by D1/D2 sequencing (see 2.1).

If all of the colonies are of the same species, it is possible to verify that a contaminant strain corresponds to less than 5% through analysis of 20 colonies, using SSR or delta PCR for the species *S. cerevisiae* (see 2.2).

If the preparation is a blend of 2 or 3 species/strains, the least represented is 15% of the total. The verification of the composition of the mix by identification of colonies is not appropriate. Indeed, for 2 strains in the blend, the less represented should produce 3 colonies out of 20 identified, picked up out of 400 on the plate.

Therefore it can be suggested that the checking for 2 or even more **species** in blend (**proportion of the different species**), use the quantitative specific PCR with probes targeting each of the expected **species**. In this case there is no preliminary plate culture. DNA is extracted directly from the sample.

For controlling **blends of same species strains (proportion of the different strains)** the only possibility up to date cannot exclude the plate culture is and identification of colonies to the strain level; the result needs to be interpreted with precaution since the representation of each strain on the plates is affected, by the growth ability on the one hand and on the other by the excessively low number of colonies that can reasonably be identified.

2.1 Identification of the species

The species is identified by DNA sequencing of the variable domain D1/D2 of 26S ribosomal region obtained by PCR amplification. It is the "method of choice" for yeast species identification: strains with more than a 1% sequence divergence of the domain D1/D2 of 600 nucleotides are not of the same species.

1. Suspend separately, colonies directly in the PCR mixture, or previously in water (about 50 µL depending on the size of the colony) and add a sample to the PCR mixture;
2. PCR mixture (final volume 50 µL): 10 mM Tris HCl pH 8, 50 mM KCl, 0.1% Triton X100 v/v, 0.2 mg/mL BSA, 3.12% v/v glycerol, 1.5 mM MgCl₂, 200 µM dNTPs, 0.1 U/µL Taq polymerase;
3. primers: NL1/NL4. NL 1 (5'-GCATATCAATAA GCGGAGGAAAAG) and NL 4 (5'-GGTCCGTGTTTCAA GACGG);

4. amplification is performed, after 10 min at 95 °C to make accessible DNA, by 30 cycles comprising the steps, 95 °C for 1 min, 55 °C for 45 s, 72 °C for 1 min, then a final step at 72 °C for 7 min;
5. PCR product is purified by any "PCR purification kit" and sequenced using the primers used for the amplification;
6. obtained sequences are compared to those available in the Genbank database (www.ncbi.nih.gov/Genbank).

2.2. Identification of strains

When the species is identified, it is possible to identify the strains. For most wine yeast species, at least the main ones used as starters, the most reliable and accurate method for identification is based on the analysis of sequence repeats (microsatellites or SSR) . Strains differ by the number of repetitions of short sequences at certain point of their genome. These loci are delimited by conserved regions that are chosen as primers for PCR amplification. The analysis consists in PCR amplification of several loci, with suitable primers for each yeast species, and measurement of their length by capillary electrophoresis for sequencing (with a degree of resolution of a single nucleotide).

Note:

1. at the time of writing, strain typing is not possible for all yeast species;
2. in order to further the advances in knowledge, suitable primers for each yeast species are chosen by referring to studies published in international peer-review scientific journals;
3. for some species about 9-12 loci are analysed; some loci are more discriminant than others;
4. the analysis can be simplified by considering first a smaller number of loci chosen for their better discriminating power, and continuing the analysis in case of ambiguity;
5. amplification can be done in multiplex (up to 9 primer pairs) for some species like *S. cerevisiae* which shorten and simplify the analysis.

For *Saccharomyces cerevisiae*, the "inter-delta PCR" profile (cf OIV-OENO 408-2011) can be used. However in case of ambiguity, when the

profiles appear different but are still very close, typing by SSR is required.

Non-Saccharomyces selected yeasts

OIV-OENO 567B-2017

1. OBJECT, ORIGIN AND FIELD OF APPLICATION

Non-*Saccharomyces* yeasts can be used for the inoculation of grapes, musts and wine according to resolution OENO-MICRO 14-546. As addition of non-*Saccharomyces* yeast might not result in the completion of alcoholic fermentation, inoculation with non-*Saccharomyces* may be followed by or carried out at the same time as inoculation with *Saccharomyces* spp.

Yeasts with desirable oenological properties must be isolated from grapes, musts or wine or result from hybridisation of grape/must/wine strains, or have been derived from other wine yeasts-

Prior to the use of genetically modified oenological yeasts authorisation by competent authorities is required.

2. LABELLING

The following information must be indicated on the packaging :

- the genus name, the species name, the name of the strain(s) and all elements that can guarantee the traceability of the product,
- the physical form of the products as described in point 3,
- the name of the selector,
- the name and contact address of the manufacturer or marketer or distributor,
- operating instructions recommended by the manufacturer,
- a recommended rate of inoculation,
- the minimum number of viable cells per gram of product (CFU as determined in 4.6) guaranteed by the manufacturer, with a recommended storage temperature,
- the manufacturing batch number, the expiration date and storage conditions,
- where relevant, the indication that the yeast strain(s) were obtained through genetic modifications and their modified character(s),
- all additives present.

3. CHARACTERISTICS

The formulation is a pure culture or a blend of non-*Saccharomyces* strains, or a blend of strains of *Saccharomyces* and non-*Saccharomyces*.

Non-*Saccharomyces* selected yeasts can be used in the following forms:

- Active Dry Yeast (ADY) with a minimum dry matter of 92% and a level of viable yeasts equal or above to 10^{10} CFU/g of dry matter,
- Active Frozen Yeast (AFY) with a range of dry matter from 40 to 85% and a level of viable yeasts equal to or above 10^{10} CFU/g of dry matter,
- Compressed Yeast (COY) with a range of dry matter from 30 to 35% and a level of viable yeasts equal to or above 10^{10} CFU/g of dry matter,
- Cream Yeast (CRY) with a range of dry matter from 18 to 25% and a level of viable yeasts equal to or above 10^{10} CFU/g of dry matter,
- Encapsulated (beads) or Immobilised Yeasts (ENY) with alginate and/or other products admitted by the OIV, with a minimum of dry matter of 86% and a level of viable yeasts equal to or above 10^9 CFU/g of dry matter,

4. LIMITS AND METHODS OF ANALYSIS

4.1 - Humidity

Measured by the weight loss of 5 g of product dried at 105 °C until it reaches a constant weight

Content should comply with the characteristics of humidity or water level described in point 3.

4.2 - Lead

Proceed with the determination according to the method in Chapter II of the *International Oenological Codex*.

Content should be less than 2 mg/kg of the suitable preparation described in point 3.

4.3 - Mercury

Proceed with the determination according to the method in Chapter II of the *International Oenological Codex*.

Content should be less than 1 mg/kg of the suitable preparation described in point 3.

4.4 - Arsenic

Proceed with the determination according to the method in Chapter II of the *International Oenological Codex*.

Content should be less than 3 mg/kg of the suitable preparation described in point 3.

4.5 - Cadmium

Proceed with the determination according to the method in Chapter II of the *International Oenological Codex*.

Content should be less than 1 mg/kg the suitable preparation described in point 3.

4.6 - Total viable yeasts

Proceed with counting according to the method in Chapter II of the *International Oenological Codex*. Content should comply with the characteristics described in point 3.

4.7 - Yeasts of genera/species/strains other than the genera/species/strains indicated on the label

The genera, species and strains indicated on the packaging should be at least 95% of the total yeast population.

See Annex 1.

4.8 - Moulds

Proceed with counting according to the method in Chapter II of the *International Oenological Codex*.

Content should be less than 10³ CFU/g the suitable preparation described in point 3.

4.9 - Lactic acid bacteria

Proceed with counting according to the method in Chapter II of the *International Oenological Codex*.

Content should be less than 10⁵ CFU/g of the suitable preparation described in point 3.

4.10 - Acetic acid bacteria

Proceed with counting according to the method in Chapter II of the *International Oenological Codex*.

Content should be less than 10^4 CFU/g of the suitable preparation described in point 3.

4.11 - Salmonella

Proceed with counting according to the method in Chapter II of the *International Oenological Codex*.

Absence should be checked on a 25 g sample.

4.12 - Escherichia coli

Proceed with counting according to the method in Chapter II of the *International Oenological Codex* using the selective differential medium for *Escherichia coli*.

Absence should be checked on a 1 g sample.

4.13 - Staphylococci

Proceed with counting according to the method in Chapter II of the *International Oenological Codex*. The presence of staphylococci is evaluated by an enrichment culture in a liquid Giolitti and Cantoni medium followed by a confirmation on a solid Baird Parker medium.

In the case that the Giolitti and Cantoni medium gives positive results, the presence of staphylococci is confirmed by isolation on a solid Baird Parker medium. A positive culture medium loop is used to inoculate solid BP mediums to obtain isolated colonies.

Absence should be checked on a 1 g sample.

4.14 - Coliforms

Proceed with counting according to the method in Chapter II of the *International Oenological Codex* using a selective differential medium for coliforms, desoxycholate gelose.

Number should be less than 10^2 CFU/g of the suitable preparation described in point 3.

5. ADDITIVES

These must be in conformity with regulations in force.

6. STORAGE CONDITIONS

Products must be stored and propagated under conditions which favour their genetic stability.

Always refer to manufacturer's recommendations.

7. PRODUCT DOCUMENTATION

Product documentation should specify guidelines about storage, transportation, handling and application conditions (temperature, activation, rehydration when needed, possibly in suitable must or wine suspensions, etc.).

ANNEX 1

1 Obtention of colonies

Sample 1 g, and suspend it under sterile conditions in 100mL sterile saccharose 5%. Homogenise and allow standing at 25-30 °C for 20 min. After adequate serial decimal dilutions, spread 0.1 mL of the diluted sample onto the surface of a nutrient YEPD agar plate (Glucose 20 g, Peptone 20 g, Yeast extract 10 g, 100 mg chloramphenicol to suppress bacterial growth and 150 mg biphenyl to suppress mould growth, Agar-agar 20 g, Water q.s.p. 1000 mL). Incubate for 6 days at 25 °C in aerobiosis. All yeast can grow, regardless of the species present.

2 Identification of contaminant genera/species/strains

Identification is carried out on the colonies isolated on plates.

As required in the characteristics, the contaminant population (which is neither the pure strain nor the different strains in case of mixed strains) should be less than 5% of the total population. After the dilutions needed to obtain individual colonies, if 20 colonies out of 300 are identified, a contaminant at 5% (ideally) should represent 1 colony out of 20.

The contaminant is identified based on the species, and therefore the genus, by D1/D2 sequencing (see 2.1). If all of the colonies are of the same species, it is possible to verify that a contaminant strain corresponds to less than 5% through analysis of 20 colonies, using SSR (see 2.2).

If the preparation is a blend of 2 or 3 species/strains, the least represented is 15% of the total. The verification of the composition of the mix by identification of colonies is not appropriate. Indeed, for 2 strains in the blend, the less represented should produce 3 colonies out of 20 identified, picked up out of 400 on the plate.

Therefore it can be suggested that the checking for 2 or even more **species** in blend (**proportion of the different species**), use the quantitative specific PCR with probes targeting each of the expected **species**. In this case there is no preliminary plate culture. DNA is extracted directly from the sample.

For controlling **blends of same species strains (proportion of the different strains)** the only possibility up to date cannot exclude the plate culture is and identification of colonies to the strain level; the result needs to be interpreted with precaution since the representation of each strain on the plates is affected by the growth ability on the one hand and on the other by the excessively low number of colonies that can reasonably be identified.

2.1 Identification of the species

The species is identified by DNA sequencing of the variable domain D1/D2 of 26S ribosomal region obtained by PCR amplification. It is the "method of choice" for yeast species identification: strains with more than a 1% sequence divergence of the domain D1/D2 of 600 nucleotides are not of the same species.

1. Suspend separately, colonies directly in the PCR mixture, or previously in water (about 50 µL depending on the size of the colony) and add a sample to the PCR mixture;
2. PCR mixture (final volume 50 µL): 10 mM Tris HCl pH 8, 50 mM KCl, 0.1% Triton X100 v/v, 0.2 mg/mL BSA, 3.12% v/v glycerol, 1.5 mM MgCl₂, 200 µM dNTPs, 0.1 U/µL Taq polymerase;
3. primers: NL1/NL4. NL 1 (5'-GCATATCAATAA GCGGAGGAAAAG) and NL 4 (5'-GGTCCGTGTTTCAA GACGG);
4. amplification is performed, after 10 min at 95 °C to make accessible DNA, by 30 cycles comprising the steps, 95 °C for 1 min, 55 °C for 45 s, 72 °C for 1 min, then a final step at 72 °C for 7 min;
5. PCR product is purified by any "PCR purification kit" and sequenced using the primers used for the amplification;
6. sequences obtained are compared to those available in the Genbank database (www.ncbi.nih.gov/Genbank).

2.2. Identification of a strain

When the species is identified, it is possible to identify the strains. For most wine yeast species, at least the main ones used as starters, the most reliable and accurate method for identification is based on the analysis of sequence repeats (microsatellites SSR). Strains differ by the number of repetitions of short sequences at certain point of their genome. These loci are delimited by conserved regions that are chosen as primers for PCR amplification. The analysis consists in PCR amplification of several loci, with suitable primers for each yeast species, and measurement of their length by capillary electrophoresis for sequencing (with a degree of resolution of a single nucleotide).

Note:

1. at the time of writing strain typing is not possible for all yeast species;

2. in order to further the advances in knowledge, suitable primers for each yeast species are chosen by referring to studies published in international peer-review scientific journals;
3. for some species about 9-12 loci are analysed; some loci are more discriminant than others;
4. the analysis can be simplified by considering first a smaller number of loci chosen for their better discriminating power, and continuing the analysis in case of ambiguity;
5. amplification can be done in multiplex, which shortens and simplifies the analysis.

YEAST EXTRACTS CONTAINING MANNOPROTEINS

OENO 26/2004;
OIV-OENO 674-2022

1. OBJECT, ORIGIN AND FIELD OF APPLICATION

Mannoproteins are extracted from *Saccharomyces cerevisiae* yeast cell walls by physico-chemical or enzymatic methods.

Mannoproteins are different structures depending on their molecular weight, their degree and type of glycosylation, and their load size. Depending on their extraction mode, they have different tartaric and/or protein stabilisation of wine.

2. LABELLING

The label must indicate the field of application (tartaric and/or protein stabilisation of wine), security and storage conditions in addition to the date of expiry.

For solution preparations, the concentration of mannoproteins, the content of sulphur dioxide must likewise be indicated.

3. CHARACTERISATION

- Mannoproteins are found in powder form, usually microgranulated, white or beige in colour, odorless, or in a colloidal solution, yellow in colour, translucent.

3.2 - Mannoproteins are water soluble and insoluble in ethanol. In solution form, they precipitate when 1 volume of ethanol is added.

Their water solubility is determined by comparing the total dry matter (DM) with the insoluble DM that remains after a hot wash, according to the method described in Annex 2. The percentage of insoluble DM should be less than or equal to 1% ± 0.5.

TRIALS**4.1 Loss through desiccation**

Powder mannoprotein:

Put 5 g of mannoproteins in a 70 mm diameter silica capsule. Place in 100-105 °C drying chamber for 5 hours. Weight loss must not be more than 15%.

Mannoproteins in solution:

Put 10 g of mannoproteins in a 70 mm diameter silica capsule. Put over 100 °C water bath for 4 hours in a 100-105 °C drying chamber for 3 heures.

The quantity of dry residue must be at least 10%.

The limits set below are related to dry products.

4.2 Ashes

Incinerate dry residue at 550-600 °C. Ash content must not be more than 8%.

4.3 Preparation of solution for trials

Prepare a 10 g/l mannoprotein solution in water.

In the case of mannoprotein solution, weigh amount corresponding to 5 g of dry residue, evaporate until almost dry and dissolve again to 10 g/l in water.

4.4 Heavy metals

Determine iron on the solution prepared for trials (4.3) according to the method described in Chapter II of the International Oenological Codex

The content expressed in lead must be less than 30 mg/kg.

4.5 Lead

Determine lead on the solution prepared for trials (4.3) according to the method described in Chapter II of the International Oenological Codex

The content expressed in lead must be less than 5 mg/kg.

4.6 Mercury

Determine mercury on the solution prepared for trials (4.3) according to the method described in Chapter II of the International Oenological Codex without evaporating the solution.

The content of mercury must be less than 0.15 mg/kg.

4.7 Arsenic

Determine arsenic according to the method described in Chapter II of the International Oenological Codex on a solution for trials (4.3)

The content of arsenic must be less than 1 mg/kg.

4.8 Cadmium

Determine cadmium according to the method described in Chapter II of the International Oenological Codex on a solution for trials (4.3)

The content of cadmium must be less than 0.5 mg/kg.

4.9 Total nitrogen

Introduce 5 g of mannoproteins in a 300 ml mineralisation flask with 15 ml of concentrated sulphuric acid (R) and 2 g of mineralisation catalyser (R). Continue the determination as indicated in Chapter II of the International Oenological Codex.

In the case of mannoprotein solution, weigh an amount corresponding to 5 g of dry residue, evaporate until almost dry then proceed as in the above.

The content of nitrogen must be between 5 and 75 g/kg

4.10 Microbiological analysis**4.10.1 Total aerobic mesophile flora**

Proceed with counting according to method described in Chapter II of the International Oenological Codex.

Not more than 10 000 total aerobic mesophile germs in 1 g.

4.10.2 Coliforms

Proceed with counting according to method described in Chapter II of the International Oenological Codex.

Not more than 10 CFU/g of preparation.

4.10.3 *Staphylococcus aureus*

Proceed with counting according to method described in Chapter II of the International Oenological Codex.

Absence checked for *Staphylococcus aureus* on a 1 g sample.

4.10.4 Salmonella

Proceed with counting according to method described in Chapter II of the International Oenological Codex.

Absence checked for salmonella on a 25 g sample

4.10.5 *Escherichia coli*

Proceed with counting according to method described in Chapter II of the International Oenological Codex.

Absence checked for *Escherichia coli* on a 25 g sample.

4.10.6 Lactic bacteria

Proceed with counting according to method described in Chapter II of the International Oenological Codex.

Not more than 10^4 CFU/g of preparation.

4.10.7 Mould

Proceed with counting according to method described in Chapter II of the International Oenological Codex.

Not more than 50 CFU/g of preparation.

4.10.8 Yeasts

Proceed with counting according to method described in Chapter II of the International Oenological Codex.

Not more than 10^2 CFU/g of preparation.

4.11 Polysaccharides

4.11.1 Principle:

Measure colour intensity using hot phenol solution in a sulfuric medium.

4.11.2 Products:

4.11.2.1 15 mg/l mannoprotein solution

Dissolve 150 mg of mannoproteins in 100 ml of distilled water, then dilute this solution 1/100 with distilled water.

4.11.2.2 50 g/l phenol solution

Dissolve 5 g of pure phenol in 100 ml of distilled water.

4.11.3 Protocol:

200 μ l of phenol (4.11.2.2) then 1 ml of pure sulphuric acid (R) are added to 200 μ l of solution to be determined (4.11.2.1). After immediately mixing, the tubes are heated at 100°C in a bath water for 5 minutes and then cooled to 0 °C.

After reaching room temperature, absorbance is measured at 490 nm. 100 mg/l mannose solution is the reference solution.

(Content of polysaccharides expressed in equivalent of mannose above 600 g/kg)

4.12 Centesimal composition of glucidic monomers

4.12.1 Principle:

Enzymatic determination of glucose and mannose after acid hydrolysis.

The determination of mannose is carried out following the determination of fructose and the addition of phosphomannose isomerase (PMI).

4.12.2 Products:

4.12.2.1 Mannoprotein solution 5 g/l

Dissolve 500 mg of mannoproteins in 100 ml of distilled water.

4.12.2.2 Sulphuric acid solution 5 M

Place 28 ml of sulphuric acid in 100 ml of distilled water.

4.12.2.3 Potassium hydroxide solution 10 M

Dissolve 46 g of potassium hydroxide in 100 ml of distilled water.

4.12.2.4 Phosphomannose isomerase 616 U/ml.

4.12.3 Protocol:

Place 100 µl of solution to be determined (4.12.2.1) in airtight sealed tubes and add 1 ml of sulphuric acid (4.12.2.2). After mixing, the tubes are heated at 100 °C in a water bath for 30 minutes and then cooled to 0 °C. After room temperature is reached, 1 ml of potassium hydroxide is added to neutralise the medium.

The determination of glucose and mannose can be carried out according to the method described in the compendium. Mannoproteins must contain at least 70% of mannose compared to total polysaccharides determined in 4.11.

4.13 Mannoprotein efficiency test with regards to tartaric precipitation

4.13.1 Principle:

Determination of dose of mannoproteins to delay crystallisation of potassium hydrogenotartarate in a hydroalcoholic solution.

4.13.2 Produits:

Crysalised tartaric Ac: PM = 150.05

Ethanol at 95% volume

Potassium chloride: PM= 74,5
Potassium hydrogenotartrate: PM= 188

4.13.3 Protocol:

4.13.3.1 Mannoprotein solution 10 g/l

Dissolve 1 g of mannoproteins in 100 ml of distilled water.

4.13.3.2 Hydro-alcoholic matrix

In a 1 liter volumetric flask half filled with distilled water dissolve:

- Tartaric acid: 2.1 g
- Potassium chloride: 1.1 g
- Ethanol at 95 % volume: 110 ml

Homogenise and fill up with distilled water.

4.13.4 Test:

Place increasing quantities of mannoprotein solution (4.13.3.1) in a 100ml volumetric flask 0 – 1 – 2 – 3 - 4 ml and the volume is brought up to 100 ml with hydro-alcoholic matrix (4.13.3.2). These quantities correspond to final quantities of 0 – 100 – 200 – 300 - 400 mg/l of mannoproteins.

Add 100 mg potassium hydrogenotartrate in each flask.

Heat at 40 °C in a water bath for 1 hour until the complete solubilization of potassium hydrogenotartrate.

Stack the flasks in a refrigerator at 4 °C.

Observation after 48 hours:

The reference flask containing 0 ml of mannoprotein solution (4.13.3.1)

Presents potassium hydrogenotartrate crystals.

The absence of crystals in flasks containing mannoproteins aids in appraising the effectiveness. In all cases, crystals must be absent in a solution containing 400 mg/l of mannoproteins.

4.14 Mannoprotein efficiency test regarding protein casses

4.14.3 Principle

Determination of mannoprotein dose needed to improve protein stabilisation of wine.

4.14.4 Product:

Bovine serum albumen (Fraction V) (BSA)

4.14.5 Protocol:

4.14.5.1 10 g/l bovine serum albumen solution

Dissolve 2 g of bovine serum albumen in 200 ml of distilled water.

4.14.3.2 20 g/l mannoprotein solution

Dissolve 2 g of mannoproteins in 100 ml of distilled water.

4.14.4 Test

Place 1 ml of BSA solution (4.14.3.1) in two 100 ml volumetric flasks and bring up to 100 ml in each flask with dry white wine which presents no cloudiness with heating (or stabilised if necessary with an adequate dose of bentonite treatment), and homogenize.

Adjust 0 and 1 ml of mannoprotein solution (4.14.3.2) and homogenize. These quantities correspond to 0 and 200 mg/l final doses of mannoproteins.

Filter reference and treated solutions through a membrane with a 0.45 µm pore diameter. Pour the filtered solutions in two 50 ml flasks.

Place the 2 50 ml flasks and heat at 80 °C in a water bath for 30 minutes. Let cool to room temperature for 45 minutes, measure turbidity of reference and treated solution.

The decrease in turbidity between the reference sample and the treated sample must be at least 50%.

4.15 Dosage in wine

Principle

The dosage of mannoproteins in wine can be carried out after precipitating ethanol (5 volumes), acid hydrolysis from the precipitate and determination of released mannose according to the method listed in the annex.

5. STORAGE CONDITIONS

Solid mannoproteins must be stored away from humidity in a sealed pack in a temperate room.

Mannoproteins present in colloidal solutions ready to be used must be stored in a hermetically sealed container.

Annex 1

Determination of mannose using enzymatic method**Principle**

Mannose is phosphorylated like glucose and fructose:

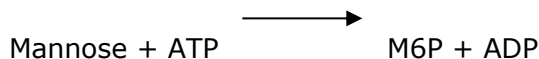

Following the determination of glucose and fructose, mannose-6-phosphate is transformed due to the action of phosphomannose isomerase (PMI) in fructose-6-phosphate.

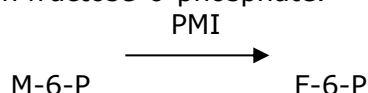

Fructose-6-phosphate formed again is transformed as before in glucose-6-phosphate which is dosed.

Protocol

Place 5 ml of wine in a centrifuge tube and add 25 ml of 95% ethanol, after mixing the tubes are put in a 4°C refrigerator for 12 hours. The precipitate formed is recuperated by a centrifuge, washed 2 times by 10 ml of 95% ethanol. The hydrolysis of the precipitate is carried out as in 4.12.

This determination does not enable the differentiation of mannoproteins added and natural mannoproteins.

Additional reagent regarding the method of the Compendium of International Methods of Analysis of Wines and Musts

Solution 6: phosphomannose isomerase (616 U/ml).
the suspension is used without diluting.

Determination

After measuring A_3 following the methods of the Compendium of Methods of Analysis of Wines and Musts, add

Solution 6	Reference 0.02 ml	Determination 0.02 ml
------------	----------------------	--------------------------

Mix; carry out the determination after 30 min; monitor the end of the reaction after 2 min. (A_4)

Determine the absorbances differences:

$A_4 - A_3$ corresponding to mannose for the reference and the determination

Subtract the absorbance difference for the reference (ΔA_T) and for the determination (ΔA_D) and establish: $\Delta A_M = \Delta A_D - \Delta A_T$ for mannose.

Results

For mannose: $Cg/l = 0.423 \times \Delta A_M$ is obtained .

Remark: If the measurements were carried out with wave lengths 334 or 365 nm, we obtain:

For a 334 nm measurement:

For mannose: $Cg/l = 0.430 \times \Delta A_M$

365 nm measurement

For mannose: $Cg/l = 0.783 \times \Delta A_M$

Annex 2

DETERMINATION OF THE PERCENTAGE OF INSOLUBLE DRY MATTER

1 – PRINCIPLE

The analysis consists of comparing the total dry matter (DM) of the yeast mannoprotein preparation with the insoluble DM that remains after a hot wash.

2 – MATERIAL AND REAGENTS

2-1 4200 rpm (6000g) Centrifuge and accessories

2-2 Scales with 0.1 mg precision

2-3 Oven at 105 °C +/- 1 °C

3 – PROCEDURE

Obtaining the insoluble part of the yeast mannoprotein preparation

- Place approx. 10 g of yeast mannoprotein preparation, previously placed in an oven at 105 °C until constant weight, in a tared centrifuge bucket. Note the exact weight, which will be referred to as M1.
- Suspend in hot water (70-80 °C).
- Stir.
- Centrifuge for 10 min at 4200 rpm (6000g).
- Discard the supernatant, stir again into hot water and centrifuge for 10 min at 4200 rpm.
- Carry out the procedure a third time.
- Place the tared centrifuge bucket containing the centrifugation pellet in an oven at 105 °C until constant weight. Note the weight. M2 is the weight of the residue of yeast mannoproteins preparation that make up the insoluble DM.

4 – CALCULATIONS

Insoluble dry matter percentage (Insoluble DM %) = $(M2/M1) \times 100$

YEAST PROTEIN EXTRACTS (YPE)

OIV-OENO 452-2012

1. OBJECT, ORIGIN AND SCOPE OF APPLICATION

The proteins of yeast protein extracts mainly come from the cytoplasm of *Saccharomyces sp.* yeast. These are separated by physical methods after an extraction process that limits their hydrolysis.

The proteins of yeast protein extracts have variable molecular weights and electric charges depending on the manner in which they were obtained and they are capable of flocculation in musts and wines so as to enable clarification and colloidal stabilizing (fining operations).

When the yeast protein extracts come from genetically modified oenological yeasts, they must have been subject to the prior authorisation of the competent authorities.

2. LABELLING

The label must include the following:

- the scope of application (must and wine fining)
- the conditions of safety and conservation as well as their shelf life
- possible admixtures
- the manufacturing batch number
- the indication of whether the protein extracts come from yeasts obtained through genetic modifications and their modified character if that is the case.

3. ANALYSIS

3.1 - The YPEs are in the form of powder, generally with micro-granulate, of yellow-to light beige or beige colour, with a slight smell of yeast.

3.2 - The YPEs are water-soluble but not ethanol-soluble.

When in aqueous solution, they precipitate if 1 volume of ethanol is added.

3.3 – Protein determination

3.3.1 Total proteins

The determination of proteins is to be carried out with the Lowry method as described in appendix 1.

The total protein content of YPEs must be greater than 50% of the dry product.

3.3.2 Size of proteins

The assessment of the proteins' size or weight is carried out by electrophoresis separation technique SDS-PAGE, as described in appendix 3.

Example of different yeast protein extract profiles with Coomassie blue staining:

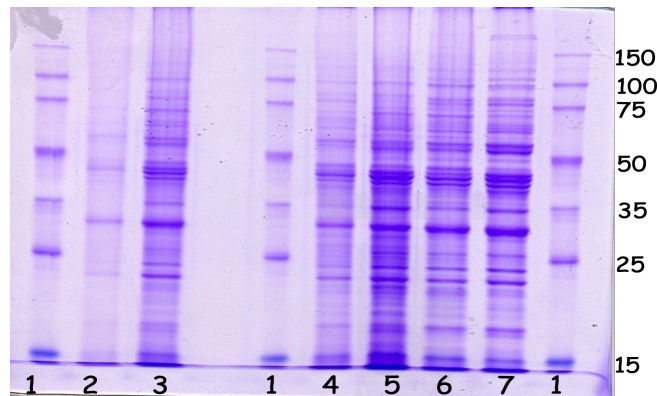

- 1: Size marker
- 2: Strain 1 Exponential phase
- 3: Strain 1 Stationary phase
- 4: Strain 2 Exponential phase
- 5: Strain 2 Stationary phase
- 6: Strain 3 Exponential phase (Strain without protease A)
- 7: Strain 3 Stationary phase (Strain without protease A)

3.3.3 Protein level greater than 15 KDa

This level is assessed using the gel permeation technique described in appendix 4.

At least 50% of the total proteins must have a molecular weight greater than 15 kDa.

3.4 Amine Nitrogen

The amine nitrogen content given as glycine, represents 10 to 20% of the dry product maximum

- The determination of amine nitrogen may be carried out by the Dinitrofluorobenzene method (DNFB) described in appendix 2.

4. TESTING

4.1 Desiccation-related losses

Put 5g of YPE in a 70mm silica capsule then place in an incubator at 100-105 °C for 5 hours. The loss of weight must not exceed 15.p.100.

The limiting values indicated below are for dry product.

4.2 Ash

Incinerate the dry residue at 550-600°C. The ash content must not exceed 8%.

4.3 Preparation of the solution for testing

Prepare an YPE solution at 10g/l in water.

4.4 Lead

Determine the lead content of the solution prepared for testing purposes (4.3) with the method described in chapter II of the International Oenological Codex.

The lead content must not exceed 2mg/kg.

4.5 Mercury

Determine, without evaporating the solution, the mercury content of the solution prepared for testing purposes (4.3) with the method described in chapter II of the International Oenological Codex.

The mercury content must not exceed 1 mg/kg.

4.6 Arsenic

Determine the arsenic content of the solution prepared for testing purposes (4.3) with the method described in chapter II of the International Oenological Codex.

The arsenic content must not exceed 3 mg/kg.

4.7 Cadmium

Determine the cadmium content of the solution prepared for testing

purposes (4.3) with the method described in chapter II of the International Oenological Codex.

The cadmium content must not exceed 1 mg/kg.

4.8. MICROBIOLOGICAL ANALYSIS

4.8.1 Total aerobic mesophilic flora

Carry out the enumeration with the method described in Chapter II of the International Oenological Codex.

The number must not exceed 10,000 total aerobic mesophilic bacteria in 1g.

4.8.2 Coliforms

Carry out the enumeration with the method described in Chapter II of the International Oenological Codex.

The number must not exceed 10CFU/g of dry matter.

4.8.3 Staphylococcus

Carry out the enumeration with a method that is to be described in Chapter II of the International Oenological Codex.

Controlled absence of *Staphylococcus aureus* in a 1 g sample of dry matter.

4.8.4 Salmonella

Carry out the enumeration with the method described in Chapter II of the International Oenological Codex.

Controlled absence of salmonella in a 25 g sample of dry matter.

4.8.5 *Escherichia coli*

Carry out the enumeration with the method described in Chapter II of the International Oenological Codex.

Controlled absence of *Escherichia coli* in a 25 g sample of dry matter.

4.8.6 Lactic bacteria

Carry out the enumeration with the method described in Chapter II of the International Oenological Codex.

The number must not exceed 10³ CFU/g of dry matter.

4.8.7 Mould

Carry out the enumeration with the method described in Chapter II of the International Oenological Codex.

The number must not exceed 50 CFU/g of dry matter.

4.8.8 Yeasts

Carry out the enumeration with the method described in Chapter II of the International Oenological Codex..

The number must not exceed 10^2 CFU/g of preparation.

4.9. EFFICIENCY TEST OF YPES FOR THE FINING OF MUSTS AND WINES**4.9.1 Principle**

The aim is to determine the most compatible quantity needed to achieve fast clarification and colloidal stability of the wine.

4.9.2 Product:

Musts or wines to undergo fining

4.9.3 Protocol:

4.9.3.1 YPE solution at 2%

Dissolve 2 g of YPE in 100 ml of distilled water.

4.9.4 Fining test

Place 100 ml of must or wine in as many 100 ml tubes as determinations selected. In practice, the comparison of 4 determinations is sufficient, i.e. five 100 ml tubes, including the control.

Add 0 ml (control), 1.5 ml, 2 ml, 2.5 ml of the YPE solution (4.9.3.1) for a red wine and 0.5 ml, 1 ml, 1.5 ml of YPE solution for a white or rosé must or for a white or rosé wine. These quantities correspond respectively to the final determinations of 0 mg/l, 200 mg/l, 300 mg/l, 400mg/l and 500 mg/l for a red wine and to 0 mg/l, 100 mg/l, 200 mg/l and 300 mg/l for a white or rosé must or for a white or rosé wine.

- Homogenise each tube after admixture of the YPE solution (cover the tubes with a film and shake 2 to 3 times by hand).

Note the turbidity increase speed and the apparition of flakes every 10 minutes for 30 minutes. After 8 hours compare each test and monitor:

- turbidity
- the volume of lees,
- the colouring intensities,
- the organoleptic quality,
- the colloidal stability by heating to 80°C for 20 minutes in a water

bath or incubator at 100 °C and rapid cooling under a stream of cold water.

5. CONSERVATION

The yeast protein extracts have a 3 year shelf-life in closed packaging if stored in temperate facilities and kept away from humidity.

6. BIBLIOGRAPHY

- Feuillat M. (1986). Autolysats de levures à usage œnologique et leur procédé de fabrication. France.
- Feuillat M. (1987). "Préparation d'autolysats de levures et addition dans les vins effervescents élaborés selon la méthode champenoise." *Rev. Fr. Oeno* 109: 17-27.
- Charpentier C. and Feuillat M. (1992). *Yeast autolysis. Wine microbiology and biotechnology.* F. G.H. Chur, Harwood Academic Publisher.
- Charpentier C. and Freyssinet M. (1989). "The mechanism of yeast autolysis in wine." *Yeast*: S1 S48.
- Charpentier C. (2000). "Yeast autolysis and yeast macromolecules? Their contribution to wine flavor and stability." *Am. J. Enol.Vitic.* 51: 271-277.
- Charpentier C., Caillet M.M, Feuillat M. (2006) Essais de collage de moûts blancs et de vins rouges avec un extrait protéique levurien : comparaison avec les colles traditionnelles. *Rev. Œnologues* 120, juillet 2006.

Appendix 1:**1. Lowry Method****2. Introduction**

The proposed method is that of LOWRY (LOWRY et al. 1951) but can be replaced by other methods such as that of BRADFORD (1976).

Bradford, M. M. (1976) *A Rapid and Sensitive Method for the Quantitation of Microgram Quantities of Protein Utilizing the Principle of Protein-Dye Binding*. Anal. Biochem. 72:248-254.

3. Scope

The LOWRY method is derived from that of Biuret: in an alkaline medium, copper ions form with proteins a pink-purple copper complex characteristic of peptide bonds. The method is 100 times more sensitive than the Biuret method.

4. Definition

The LOWRY method consists in copper complexing, in an alkaline medium, approximately a quarter of the amino acids constituting the proteins. The Folin Ciocalteu reagent (phosphomolybdic reagent) reacts with the aromatic amino acids of the proteins.

The absorbance of the complex thus formed is determined spectrophotometrically at 750 nm. The main drawback of this method is the interference of the Folin reagent with other compounds (EDTA, dithioerythritol, oxidized glutathione, etc.).

The determination of the water-soluble proteins is performed by comparison with a standard curve plotted on the basis of protein solutions of known concentrations. (BSA type).

5. Reagents and Products

- Solution A: solution of 2% Na₂CO₃ in 0.1 M NaOH containing 0.02% (500 mL) of sodium tartrate (or potassium).
- Solution B: solution of 5% CuSO₄.5 H₂O (100 mL).
- Reagent C: produce extemporaneously 50 mL of solution A + 1 mL of solution B.

- FOLIN-CIOCALTEU reagent: commercial solution.
- Standard solution of Bovine Serum Albumin (BSA).

6. Equipment

- Test tubes
- Class A pipettes
- Micropipettes
- Plastic film for sealing
- Visible Spectrophotometer

7. Procedure

7.1 Standard range of proteins: preparation and determination

The standard range is made using a standard solution of 0.5 mg.mL^{-1} of BSA.

- In graded 100-mL flasks, prepare solutions of BSA containing 0, 100, 200, 300, and 400 $\mu\text{g.mL}^{-1}$ of BSA from the stock solution.
- Dispense into test tubes 0.6 mL each dilution. A control tube contains only 0.6 mL of distilled water

Thoroughly mix each solution by inversion.

- Add to each tube:
 - 3 mL of reagent C
 - Close the tube with the plastic wrap and homogenise by inversion
 - Let the tubes stand for 10 minutes before adding 0.3 mL of Folin reagent.
 - Homogenize.
 - Wait 30 minutes in the dark and then measure the absorbance at 750 nm by adjusting the zero of the distilled water solution (concentration in BSA $0 \mu\text{g. mL}^{-1}$).
 - Plot the curve $OD = f(\text{protein concentration})$.

7.2 Determination of proteins in the Yeast Protein Extract

- In 3 test tubes add successively:
 - 0.6 mL of extract diluted to $1/20^{\text{th}}$, $1/30^{\text{th}}$, and $1/40^{\text{th}}$ (30, 20 and 15 μl in 0.6 mL)
 - 3 mL of reagent C; homogenize after sealing the tubes and let them stand for 10 minutes.
 - 0.3 mL of Folin reagent, homogenise.

- Wait 30 minutes in the dark
- Measure the absorbance at 750 nm.

8. Calculations

- Note: If the absorbance values are low, recommence the procedure using smaller dilutions of **yeast protein extract** ($1/10^{\text{th}}$, $1/5^{\text{th}}$, $1/4$ i.e. 60, 120 and 150 μl in 0.6 mL).
- Determine by comparing with the standard curve the protein concentration in the YPE in $\mu\text{g.mL}^{-1}$ then in mg.mL^{-1} by direct reading or by using the regression line of the standard curve (specify on the standard curve the equation for the line and the correlation coefficient).

Appendix 2:**1. Dinitrofluorobenzene method****2. Introduction**

This method is used to quickly determine the amino nitrogen in a biological solution compared with a standard range produced with a solution of glycine.

3. Scope

Oenological products of plant or animal origin

4. Definition

Dinitrofluorobenzene (DNNFB) reacts with free NH_2 functions contained in the amino acids to give a bright yellow compound determined by colorimetry at 420 nm. The reaction takes place at $\text{pH} > 9.3$.

5. Reagents and Products

Reagents:

- Borax or sodium tetraborate
- 10 M Hydrochloric acid dinitrofluorobenzene
- Glycine

6. Equipment

- haemolysis tubes
- micropipettes
- Visible spectrophotometer
- Water bath at 60°C

7. Sampling

- Prepare a solution of 5% sodium tetraborate in pure water
- Prepare a solution with DNFB: introduce 130 μl of DNFB in 10 mL of 95% pure ethanol.
- Prepare a solution of hydrochloric acid 2M
- Produce a standard range from a stock solution of glycine with 2 g/l ($M = 75.07 \text{ g}$) e.g. 0.50 mg/l, 100 mg/l, 200 mg/l, 500 mg/l
- Prepare a solution with 2 g/l of the product to be titrated

8. Procedure

- In a test tube, insert:

- 380 µl of 5% Borax
- 20 µl of the sample to be titrated
- 20 µl of the DNFB solution
- perform in identical fashion with the glycine range

- Stir and place in water bath at 60°C for 30 min
- Add 3 mL of HCL 2M
- Stir and read the specific absorbance at 420 nm for the sample
- Produce a calibration curve with the Glycine range

9. Results

Plot the value of absorbance at 420 nm for the sample on the calibration curve

The results are expressed in g/l of Glycine.

Appendix 3

Protein separation by SDS-PAGE

1. INTRODUCTION

SDS-PAGE (polyacrylamide gel electrophoresis) is a variant of electrophoresis commonly used to separate proteins by their molecular weight

2. Scope

Evaluation of the molecular weight of proteins of plant or animal origin. This method can be applied to all products of biological origin and winemaking products containing proteins.

3. Principle

The determination of the molecular weights of proteins is carried out by SDS-PAGE using the Laemmli method (1970). This technique enables the separation of proteins according to their molecular weight using Sodium Dodecyl Sulphate or SDS, a strongly negatively charged molecule, which standardizes their charges and make them lose their native three-dimensional structure. The migration rate of the whole SDS / denatured molecule depends only on the molecular weight of the proteins. Prior to protein denaturation with SDS, the disulphide bonds of the proteins must be reduced by 2-mercaptoethanol.

The migration medium consists of a polyacrylamide gel.

The gel is composed of two parts. A concentration gel which, as its name suggests, allows the proteins to concentrate before they migrate into the separating gel underneath.

The concentration gel contains 5% of acrylamide-bisacrylamide, while the separating gel contains 12%.

The migration takes place in the electrophoresis buffer chilled to 12°C and stirred for about 1 h 30 at a voltage of 80 V for the concentration gel and for nearly 3 hours at 170 V for the separating gel.

Once de-moulded, the gel undergoes staining to reveal the protein bands. The molecular weights of the bands can be measured using known size markers that have migrated with the samples. For example, using a marker sold by Sigma under the name of *Molecular*

Weight Standard Mixture with the following sizes: 15, 25, 35, 50, 75, 100 and 150 Kda.

4. Reagents and Products

4.1 Denaturation buffer

- Buffer Tris Hcl 0.125 M pH 6.8
- distilled water;
- SDS to 4%
- 2-mercaptoethanol to 10%;
- bromophenol blue to 0.2%
- pure glycerol
- Complete with distilled water

4.2 Separating gel, preparation for 30 mL

- 7.50 mL of acrylamide/bis-acrylamide
- 11.25 mL Tris/Hcl buffer to 0,75 M pH 8.8
- 0.30 mL of SDS to 10%
- 10.95 mL of distilled water
- 30 microlitres of TEMED for polymerisation
- after stirring, add 300 microlitres of ammonium persulfate to 20%

4.3 Concentration gel, preparation for 10 mL

- 1.25 mL of acrylamide/bis-acrylamide
- 1.25 mL Tris/Hcl buffer to 0,25 M pH 6.8
- 0.10 mL of SDS to 10%
- 7.4 mL of distilled water
- for the polymerisation, add 40 microlitres of TEMED
- after stirring, add 100 microlitres of ammonium persulfate to 20%

4.4 Migration buffer, preparation for 1 litre

- 12.5 mL Tris buffer 25mM pH 8,3
- 14.4 g of glycine
- 977.5 mL of distilled water
- 10 mL of SDS to 10%

5. Equipment

Electrophoresis equipment for

- - the plates
- - the clamps

- - the seal
- - the comb
- - the spacers

6. Sampling

- 6.1. Denaturing the proteins of products
- The samples are treated in the denaturing buffer, prepared just before the denaturing process.
 - 50 microlitres of samples are mixed with 50 microlitres of denaturing buffer.
 - The mixture is then heated to boiling point for 4 minutes in order to promote protein denaturation.

7. Procedure

7.1 Preparation of plates

- The electrophoresis plates are cleaned before use with water (and soap if necessary) and then with 70% alcohol.
- Wipe the plates with a paper towel, leaving no fibres on the surfaces where the gel will be poured.
- Place the seal on the round-edged plate.
- Install the spacers and the second glass plate.
- The assembly is then consolidated with clamps.

7.2 Pouring the separating gel

- As soon as it has been prepared, the separating gel is poured between two plates using a pipette.
- To avoid the presence of bubbles in the gel, the assembly is tilted during filling.
- The gel is then covered with distilled water to obtain a perfectly horizontal surface.

7.3 Pouring the concentration gel

- Remove the distilled water from the top of the separating gel
- Holding the assembly tilted, fill it with the concentration gel to the upper level of the glass plates.
- Put the comb in place to form wells in the concentration gel.

7.4 Sample deposits

- Remove the comb
- Place the plates and migration tanks in the electrophoresis tank.
- Fill the tanks with the migration buffer starting with the upper and then the lower part.

- Add 50 microlitres of denatured protein sample in each well using a syringe and the submarine technique.
- Also place a size marker in each of the wells located around the edges in order to frame the well containing the samples.
- Once the deposits have been made, the migration is initiated relatively quickly to prevent the spread of the deposits

7.5 Starting and stopping the electrophoresis

- the duration of the electrophoresis depends on several factors:
 - the generator used, the thickness of the gel, the amount of buffer used, its dilution, etc.
- Close the lid of the tank
- Check that the generator is switched off or disconnected
- Connect the wires of the generator lid
- maintain the temperature at 12°C
- Connect the generator to the mains
- Start the generator on the selected voltage: 80 volts for 1:30 for the concentration gel then 170 volts for about 3 hours for the migration in the separating gel
- Stop the electrophoresis when the bromophenol blue reaches the bottom edge of the plates.
- Switch off the generator and disconnect the power
- Disconnect the wires from the lid
- Open the electrophoresis tank
- Remove the gel on its support

8. Results

The bands perpendicular to the path of migration for each molecule of protein can be revealed using several types of staining. The intensity and thickness of the bands depend on the protein concentration.

The size marker is used to directly assess the molecular weight of the proteins in each band.

8.1 Staining of electrophoresis gels

Several types of staining can be applied to characterise the proteins present as precisely as possible.

Coomassie blue staining

After migration, the electrophoresis gels are immersed in a Coomassie blue staining solution (0.025% Coomassie Blue R250, 40% methanol, 7% acetic acid) overnight.

The next day the electrophoresis gels are soaked for 30 minutes in an initial de-staining bath (40% methanol, 7% acetic acid) to remove the excess dye. They are then placed in a second bath (5% methanol, 7% acetic acid) which is changed regularly until a virtually colourless background is obtained. The staining and de-staining steps are carried out while stirring at room temperature.

The gels are stored in distilled water before being scanned for analysis.

Staining with silver nitrate

Staining with silver nitrate can detect smaller amounts of protein than Coomassie blue staining. The products used for this staining are provided by *Biorad* and form part of the *Silver Stain Plus* kit.

Once electrophoresis has been completed, the gel is placed in a bath of 400 mL of fixing solution (50% methanol, 10% acetic acid, 10% fixative enhancer concentrate (kit), 30% distilled water) for 20 min while stirring at room temperature.

The gel is then rinsed twice with 400 mL of distilled water for 10 min to remove any acetic acid which may impair the staining step.

Staining is performed with 100 mL of a solution prepared as indicated below:

In a large beaker, place:

- 35 mL of distilled water
- 5 mL of "Silver Complex" solution
- 5 mL of "Reduction Moderator" solution
- 5 mL of "Image development" reagent

Once these products have been well mixed and just before use, 50 mL of the "Developer Accelerator" solution at room temperature are added to the beaker. The preparation is then poured over the gel in the staining dish. After a period of 20 to 60 minutes, depending on the sample and its concentration, brownish bands appear.

The reaction is then stopped with a solution of 5% acetic acid for at least 15 min, then the gel is placed for about 5 min in ultrapure water. The gels are then ready to be scanned to determine the molecular weights of the protein bands.

Staining of glycoproteins

This method is used to express the presence of glycoproteins in yeast-type products. It is performed using the "GelCode® Glycoprotein Staining" kit marketed by Pierce Biotechnology.

After electrophoresis, the gel is fixed by immersion in a bath of 300 mL of 50% methanol for 30 min while being stirred.

Wash the gel in a bath containing 300 mL of 3% acetic acid for 10 min. Repeat this step once. (The staining can be stopped after this step by placing the gel in distilled water overnight).

The gel is then covered with 25 mL of "Oxidizing Solution" while being stirred for 15 min.

The gel is then washed 3 times with 300 mL of 3% acetic acid for 5 min. A solution of 25 mL of GelCode® Glycoprotein Staining is placed on the gel for 15 min while being stirred.

Add 25 mL of "Reducing Solution" while gently stirring for 5 min.

Wash the gel thoroughly with a solution of 3% acetic acid. The glycoproteins appear as magenta bands. The gel can be stored in a solution of 3% acetic acid before being scanned.

Appendix 4

Gel permeation chromatography

1. Introduction

The proposed method is a molecule separation method. This type of chromatography is also called gel filtration or exclusion chromatography.

2. Scope

The polymer profiles are studied in the biological products using gel permeation chromatography on a column optimised for protein analysis. A double detection at 280 nm/214 nm is used to monitor the elution of molecules containing amino acids with aromatic rings and peptide bonds.

3. Definition

Gel permeation chromatography allows the separation of molecules depending on their size and shape using a column containing porous granular gel. Large molecules (with a diameter greater than that of the pores) are excluded and eluted first at the dead volume (V_m or V_0). Small and medium sized molecules are eluted later, their migration being impeded by their inclusion in the gel. The solutes are therefore eluted in reverse order of molecular weight. There is a linear relationship between the elution volume and the molecular weight logarithm.

4. Reagents and products

- $\text{NaH}_2\text{PO}_4, 2\text{H}_2\text{O}$
- $\text{Na}_2\text{HPO}_4, 2\text{H}_2\text{O}$
- NaCl
- NaOH 10 M

Compound	Molecular weight in kDa
Bovine albumin	66
Egg albumin	45
Glyceraldehyde 3 phosphate dehydrogenase	36
Bovine carbonic anhydrase	29
Bovine trypsinogen pancreas	24
Soy trypsin inhibitor	20
Lactalbumin	14.2

5. Equipment

- GE Healthcare **chromatography column**: Superdex 200 (diameter 10 mm x length 300 mm)

- Cellulose-ester filters with porosity: 0.22 µm
- Cup
- 2L beaker
- 1L volumetric flask
- 0.45 µm membranes for aqueous solution

6. Procedure

6.1 Chromatography buffer and conditions

In a cup, weigh:

$\text{NaH}_2\text{PO}_4, 2 \text{ H}_2\text{O} = 1.56 \text{ g}$

$\text{Na}_2\text{HPO}_4, 2 \text{ H}_2\text{O} = 1.58 \text{ g}$

$\text{NaCl} = 14.63\text{g}$

- Decant into a beaker containing 0.9 litres of ultrapure water. The pH of this solution should be approximately 6.5. Bring it to pH = 7.2 using NaOH 10 M.

- Decant into a 1L volumetric flask and make up to 1L with ultrapure water. Filter through 0.45 μm membrane for an aqueous solution. The flow is set at 0.6 mL/min.

6.2 Preparing the samples

To analyse a product in a powder form for example, dilute 1 g in 100 mL of ultrapure water. Filter the sample through a 0.22 μm cellulose-ester filter

6.3 Column calibration

To calibrate the column, plot a curve from the log of the molecular weight of the molecular weight solutions according to the retention time. Inject the sample solution according to this.

7. Results

Inject the molecular weight solution mixture as indicated in point 7.3. Plot the curve of the log of the solutions' molecular weight according to the retention time. Determine the molecular weights of the product's peaks by referring to this curve.

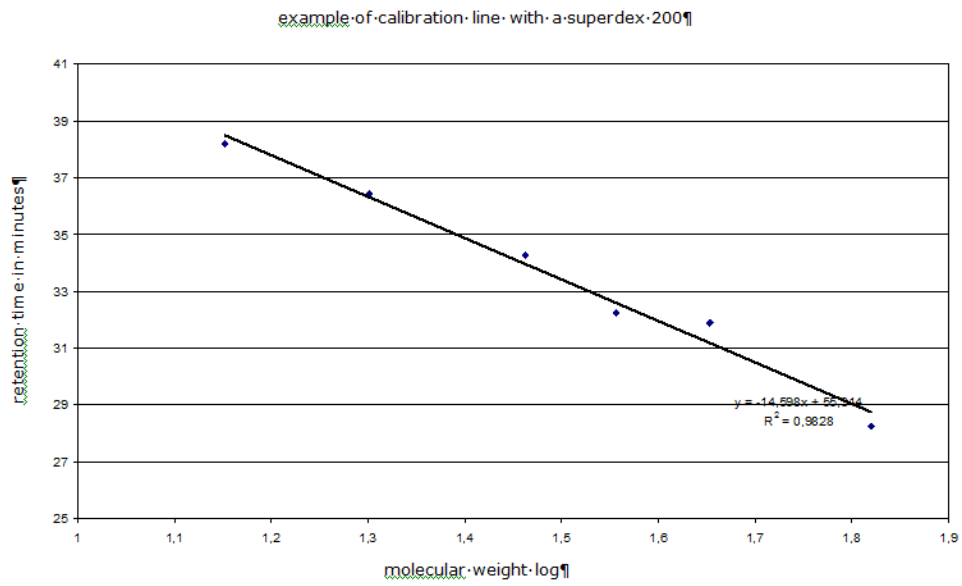

YEAST AUTOLYSATES

OIV-OENO 496-2013

1. OBJECT, ORIGIN AND SCOPE OF APPLICATION

Yeast autolysates are used as nutrients during the rehydration of dry active yeasts intended for alcoholic fermentation, and also as nutrients during alcoholic fermentation. Yeast autolysates are derived from *Saccharomyces* spp. yeast biomass. They are obtained from yeast biomass through autolysis, in some cases combined with heat treatment and/or modification of the pH. Autolysis is defined as the self-digestion of proteins and other cell tissues by the enzymes contained within the yeast cells.

The micro-organism production techniques are those conventionally used for yeast biomasses. There is no addition of antibiotics or compounds during the process other than those required for yeast growth. If the autolysates come from genetically modified yeasts, the yeasts must be submitted for prior authorisation by the competent authorities.

2. LABELLING

The label must indicate:

- the name of the genus and the species of the yeast autolysate,
- the organic nitrogen content,
- the amino acid content,
- any additives,
- instructions for use,
- the batch number, the expiry date, and the storage conditions in terms of well-defined temperature, humidity and ventilation conditions,
- if applicable, the indication that the autolysates were obtained from genetically modified yeasts, and the modified characteristic.

3. CHARACTERISTICS

In solid form they are available as powder, flakes or granules, light yellow to brown in colour, with an odour characteristic of yeast. In liquid form, they are available in tan to brown colour.

Yeast autolysates are highly water-soluble. The soluble part is less than 80% of the dry matter. The soluble part of the dry matter present in the liquid autolysate must also be less than 80%.

4. LIMITS AND TEST METHODS

4.1 - Nitrogen

4.1.1. The total nitrogen content, expressed as element N, must be less than 12% of the dry matter according to the method of analysis described in Chapter II of the International Oenological Codex.

4.1.2. The ammoniacal nitrogen content, expressed as element N, must be less than 0.5% of the dry matter. It is determined by the following method.

Place 1 g of dry matter in 100 mL of 0.5 M KCl and stir for 20-30 min. Introduce the 100 mL into the steam distillation apparatus described in Chapter II of the International Oenological Codex for the determination of total nitrogen, add 50 mL of 30% sodium hydroxide (R) and distil by collecting 250 mL in a conic flask containing 5 mL of 4% boric acid (R), 10 mL of water and 2-3 drops of methyl red-methylene blue mixed indicator (R). Titrate the distillate with 0.1 M hydrochloric acid until the indicator turns pink-purple.

1 mL of hydrochloric acid solution corresponds to 1.4 mg of nitrogen N.

Where n is the number of mL poured: 100 g of yeast autolysates contain $0.14n$ g of ammoniacal nitrogen, expressed as element N.

4.1.3 Organic nitrogen equals total nitrogen minus ammoniacal nitrogen.

4.1.4 The amino acid content, in glycine equivalent, must be between 10% and 20% of dry matter, according to the DNFB method described in the appendix, or, if expressed as element N, must be between 1.9% and 3.7% of the dry matter.

4.2 - Humidity

Measured by the loss in weight of 5 g of product, dried at 105°C until the weight is constant (approximately 3 hours)

The maximum humidity of the solid forms must be less than 7%.

Heavy metal limits concern the dry matter of the dry and liquid forms.

4.3 - Lead

Determination according to the method indicated in Chapter II of the International Oenological Codex

The lead content must be less than 2 mg/kg of dry matter.

4.4 - Mercury

Determination according to the method indicated in Chapter II of the International Oenological Codex

The mercury content must be less than 1 mg/kg of dry matter.

4.5 - Arsenic

Determination according to the method indicated in Chapter II of the International Oenological Codex

The arsenic content must be less than 3 mg/kg of dry matter.

4.6 - Cadmium

Determination according to the method indicated in Chapter II of the International Oenological Codex

The cadmium content must be less than 1 mg/kg of dry matter.

4.7 - Viable yeasts

Enumerate according to the method indicated in Chapter II of the International Oenological Codex

The viable yeast count must be less than or equal to 10^2 CFU/g or per mL for the liquid form.

4.8 - Moulds

Enumerate according to the method indicated in Chapter II of the International Oenological Codex

The mould count must be less than 10^3 CFU/g or per mL for the liquid form.

4.9 - Lactic bacteria

Enumerate according to the method indicated in Chapter II of the International Oenological Codex

The lactic bacteria count must be less than 10^3 CFU/g or per mL for the liquid form.

4.10 - Acetic acid bacteria

Enumerate according to the method indicated in Chapter II of the International Oenological Codex

The acetic acid bacteria count must be less than 10^3 CFU/g or per mL for the liquid form.

4.11 - Salmonella

Enumerate according to the method indicated in Chapter II of the International Oenological Codex

Absence must be checked on a sample of 25 g, or mL for the liquid form.

4.12 - Escherichia coli

Enumerate according to the method indicated in Chapter II of the International Oenological Codex

Absence must be checked on a sample of 1 g, or mL for the liquid form.

4.13 - Staphylococci

Enumerate according to the method indicated in Chapter II of the International Oenological Codex

Absence must be checked on a sample of 1 g, or mL for the liquid form.

4.14 - Coliforms

Enumerate according to the method indicated in Chapter II of the International Oenological Codex

The coliform count must be less than 10^2 CFU/g or per mL for the liquid form.

5. ADDITIVES

They must comply with the currently applicable regulations.

6. STORAGE

Yeasts autolysates must always be stored in sealed bags sheltered from the air. Store in a cool, dry place.

In all cases, refer to the manufacturer's instructions.

Appendix 1:**Dinitrofluorobenzene method****1. Introduction**

This method is used to quickly determine the amino nitrogen in a biological solution compared with a standard range produced with a solution of glycine.

2. Scope

Oenological products of plant or animal origin

3. Definition

Dinitrofluorobenzene (DNFB) reacts with free NH_2 functions contained in the amino acids to give a bright yellow compound determined by colorimetry at 420 nm. The reaction takes place at $\text{pH} > 9.3$.

4. Reagents and Products

Reagents:

- Borax or sodium tetraborate,
- Dinitrofluorobenzene,
- 10 M Hydrochloric acid,
- Glycine.

5. Equipment

- haemolysis tubes,
- micropipettes,
- Visible spectrophotometer,
- Water bath at 60°C.

6. Sampling

- Prepare a solution of 5% sodium tetraborate in pure water,
- Prepare a solution with DNFB: introduce 130 μl of DNFB in 10 mL of 95% ethanol,
- Prepare a solution of hydrochloric acid 2M,
- Produce a standard range from a stock solution of glycine with 2 g/l (M = 75.07 g) e.g. 0.50 mg/l, 100 mg/l, 200 mg/l, 500 mg/l,
- Prepare a solution with 2 g/l of the product to be titrated.

7. Procedure

- In a test tube, insert:
- 380 µl of 5% Borax,
- 20 µl of the sample to be titrated,
- 20 µl of the DNFB solution,
- perform in identical fashion with the glycine range,
- Stir and place in water bath at 60°C for 30 min,
- Add 3 mL of HCL 2M,
- Stir and read the specific absorbance at 420 nm for the sample,
- Produce a calibration curve with the Glycine range.

8. Results

Plot the value of absorbance at 420 nm for the sample on the calibration curve.
The results are expressed in g/l of Glycine.

**CELLULAR YEAST HULLS
(YEAST WALLS)**

OENO 4/87;
OIV-OENO 497-2013

1. OBJECT, ORIGIN AND FIELD OF APPLICATION

The cellular yeast hulls are obtained from *Saccharomyces spp.* yeasts. The preparation mode must respect the surface area and consequently the adsorption capacity.

Cellular yeast hulls are found in fine powder or microgranulate forms, non-hygroscopic, cream coloured and slightly odorous. They do not leave harmful residues in grape musts and in wines. During the process, there is no addition of antibiotics or compounds other than those needed for the yeast to grow.

Cellular yeast hulls are packed under conditions which prevent oxidation.

They are used to prevent and deal with stuck fermentations. They have the property of fixing certain fatty acids (octanoic and decanoic) which disturb membrane permeability of yeasts.

When the cellular yeast hulls come from genetically engineered yeasts, these must be subject to the prior authorisation of the relevant authorities.

There is an addition limit on the usage of cellular yeast hulls.

2. LABELLING

The label must include:

- The name of the genus and species
- The instructions for use
- Any additives
- The purity, batch number, expiry date and storage conditions under well-defined temperature, humidity and ventilation conditions
- An indication whether the cellular hulls come from genetically engineered yeasts, and the modified character if this is the case.

**3. COMPOSITION OF CELLULAR YEAST HULLS
(VALUES)**

Dry matter	≥ 94% m/m according to the method described in Annex 2
Carbohydrates	> 40% m/m

Carbohydrates:

The total glucans and mannans content must be more than 60% of the total carbohydrates according to the method described in Annex 1.

Solubility	< 10% m/v
------------	-----------

4. ADDITIVES AND INGREDIENTS

According to legislation.

5. LIMITS AND TRIAL METHODS**5.1 Lead**

Proceed with an analysis according to the method described in Chapter II of the International Oenological Codex.

The content must be less than 2 mg/Kg.

5.2 Mercury

Proceed with an analysis according to the method described in Chapter II of the International Oenological Codex.

The content must be less than 1 mg/Kg.

5.3 Arsenic

Proceed with an analysis according to the method described in Chapter II of the International Oenological Codex.

The content must be less than 3 mg/Kg.

5.4 Cadmium

Proceed with an analysis according to the method described in Chapter II of the International Oenological Codex.

The content must be less than 1 mg/Kg.

6. MICROBIOLOGICAL ANALYSES*6.1 Revivable yeast*

Proceed with counting according to the method described in Chapter II of the International Oenological Codex.

Content: Less than 100 CFU per g

6.2 Lactic bacteria

Proceed with counting according to the method described in Chapter II of the International Oenological Codex.

Content: Less than 10³ CFU per g

6.3 Acetic bacteria

Proceed with counting according to the method described in Chapter II of the International Oenological Codex.

Content: Less than 10³ CFU per g

6.4 Mould

Proceed with counting according to the method described in Chapter II of the International Oenological Codex.

Content: less than 10³ CFU per g

6.5 Salmonella

Proceed with counting according to the method described in Chapter II of the International Oenological Codex.

Content: Absence checked on 25 g sample.

6.6 Escherichia coli

Proceed with counting according to the method described in Chapter II of the International Oenological Codex.

Content: Absence checked on 1 g sample.

6.7 Staphylococci

Proceed with counting according to the method described in Chapter II of the International Oenological Codex.

Content: Absence checked on 1 g sample.

6.8 Coliforms

Proceed with counting according to the method described in Chapter II of the International Oenological Codex.

Content: Less than 100 CFU/g

7. HYGIENE

Yeast hulls are produced in compliance with good food manufacturing practices.

They must not have a rancid odour and should not give an abnormal flavour to the wine (yeast flavour).

8. ACTIVITY

The stimulatory effect of yeast hulls is based on their capacity to adsorb certain toxic substances for yeasts, which they produce during the growth period. Decanoic acid is the greatest growth inhibitor.

Technological activity (TA) expressed in grams (g) of product can thus be evaluated by absorption of decanoic acid.

A gram of cellular yeast hulls added to 100 mL alcohol solution of 10% vol., pH 3.5, containing 2 mg/L decanoic acid should adsorb, after 24 hours of contact at 18-22 °C, 50% of this acid.

Monitoring can be carried out by the determination of decanoic acid by chromatography in the gaseous phase with detection by flame ionization (GC/FID) in accordance with the following procedures provided as example:

- chromatography apparatus,
- polar capillary column, for example a FFAP type column, 50 m in length and 0.2 mm in interior diameter,
- melted silica support,
- programmed temperature of 60 °C to 180 °C, or 4 °C/min,
- injected volume of 1 µL of hydro-alcoholic solution (10 % vol.) to 2 mg/L decanoic acid treated with yeast hulls,
- heptanoic acid internal standard of 2 mg/L after adding,
- reference solution: hydro-alcoholic solution (10% vol.) to 2 mg/L decanoic acid.

9. STORAGE

The cellular yeast hulls must always be stored in airtight bags in a temperate environment.

Annex 1**Determination of glucans and mannans in cellular yeast hulls**

The cellular yeast hulls are subjected to a pre-solubilisation with concentrated H₂SO₄ prior to hydrolysis with H₂SO₄ at 128 °C in an oven. This total hydrolysis of the glucans and mannans generates proportional quantities of glucose and mannose that are determined by Ionic Chromatography.

To eliminate the glycogen, the method must be preceded by a pre-washing of the sample with a 0.5 mole/L NaOH solution for 1 hour at room temperature, followed by a centrifugation and another washing with water).

1. Materials and equipment

- 100 mL capped flask (Duran or Schott Glass)
- Tube
- Polyethersulfone filter with average pore diameter of 0.45 µm
- Oven
- H₂SO₄ 72%
- Ionic chromatography system with pulsed amperometry detector containing a gold electrode
- Vortex mixer
- NaOH 32%
- 100 mL and 50 mL volumetric flasks
- Distilled water
- HPLC grade Water
- Ionic chromatography column (Metrosep Carb1 Metrohm or equivalent)

2. Method

- **2.1. Preparation of standards**
 - Weigh 50 mg of glucose (note the exact weight W_{glu}) and 50 mg of mannose (note the exact weight W_{man})
 - Go to step 2.3.
- **2.2. Sample preparation**
 - Weigh 50 mg of cellular yeast hulls (note the exact weight W_y)
 - Go to step 2.3.

- **2.3. Pre solubilisation**
 - Add 3.3 mL of H₂SO₄ 72%
 - Mix the sealed tube with a Vortex mixer
 - Leave for one hour at ambient temperature and stir every 10 min

- **2.4. Acid Hydrolysis**
 - Pour the contents of the tube into a 100 mL flask
 - Add 40 mL of distilled water
 - Close the flask
 - Put the capped flask in an oven at 128°C and incubate for 3 hours
 - Take out the flask and cool it
 - Neutralize with 8.112 mL of NaOH 32%
 - Decant the contents of the flask into a 100 mL volumetric flask
 - Adjust to 100 mL with distilled water
 - Filter the solution through an Acrodisc IC filter

- **2.5. Chromatography**
 - 2.5.1. Preparation of standards
 - Take 2.5 mL of the hydrolysed glucose and mannose solutions obtained in 2.4.
 - Transfer to a 50 mL volumetric flask
 - Adjust with distilled water
 - Put in a chromatography vial for the autosampler

 - 2.5.2. Sample preparation
 - Take 7.5 mL of hydrolysed material obtained in 2.4.
 - Transfer to a 50 mL volumetric flask
 - Adjust with distilled water
 - Put in a chromatography vial for the autosampler

 - 2.5.3. Preparation of the mobile phase
 - Measure one litre of HPLC grade water.
 - Filter using a 0.45 µm membrane
 - Degas under vacuum for 1 h 30 min
 - Measure 7.57 mL of NaOH 51% into the flask intended for the mobile phase
! Be careful to use only a polypropylene flask for the mobile phase

- Add the 1 litre of degassed water
 - Stir using a magnetic stirrer
 - 2.5.4. Calibration solutions for chromatography
 - Prepare, using HPLC grade water, solutions of glucose and mannose at 10 mg/L, 30 mg/L and 40 mg/L
 - Use them for calibrating the chromatography
 - 2.5.5. Chromatographic Conditions
 - Condition the column using the mobile phase at a flow rate of 1 mL/min for 2 hours.
 - Inject 20 µL of :
 - The three calibration solutions (§2.5.4.)
 - The standard solution
 - The standard solution
- Calibrate the system with the calibration solution. Trace the calibration curves $\text{Area} = f(\text{concentration})$

The chromatography equipment will give the concentration in mg/L for:

the standard solution:

Concentration of Mannose in mg/L: C_{manSt} (mg/L)

Concentration of Glucose in mg/L: C_{gluSt} (mg/L)

the sample solution :

Concentration of Mannose in mg/L: C_{manY} (mg/L)

Concentration of Glucose in mg/L: C_{gluY} (mg/L)

3. Calculation

• 3.1. Yield calculation

Calculate the recovery yield for the standard mannose and glucose solutions as follows:

$$Y_{\text{man}} = C_{\text{manSt}} (\text{mg/L}) / W_{\text{man}} (\text{mg}) \times 10 \times (2.5/50)$$

$$Y_{\text{glu}} = C_{\text{gluSt}} (\text{mg/L}) / W_{\text{glu}} (\text{mg}) \times 10 \times (2.5/50)$$

W_{man} and W_{glu} are the measured weights of mannose and glucose in mg (See §2.1.)

4. Concentration of mannans and glucans in cellular yeast hulls

Concentration of mannans in g% m/m:

$$\mathbf{C_{mannans} = 0.9 * [(C_{manY} \times (50/7.5)) / (W_y \text{ (mg)} \times 10)] * (1/Y_{man})}$$

Concentration of glucans in g% m/m:

$$\mathbf{C_{glucans} = 0.9 * [(C_{gluY} \times (50/7.5)) / (W_y \text{ (mg)} \times 10)] * (1/Y_{glu})}$$

W_y: weight of cellular yeast hulls (see § 2.2.)

Y_{man} and Y_{glu}: yields of mannose and glucose (see § 3.1.)

Annex 2

DETERMINATION OF THE PERCENTAGE OF INSOLUBLE DRY MATTER

1 – PRINCIPLE

The analysis consists in comparing the total dry matter (DM) of the cellular yeast hulls with the dry matter remaining (insoluble DM) after a hot wash.

2 – MATERIAL AND REAGENTS

4200 rpm centrifuge and accessories
Scales at 1/10 mg
Weighing cabinet for DM (FST 350)
Oven at 105 °C +/- 1 °C

3 – METHOD

Obtaining the insoluble part of the cellular yeast hulls
In a calibrated centrifuge crucible, place around 10 g of cellular yeast hulls dried beforehand to constant weight in an oven at 105 °C. Note the exact weight, which is: M1.
Stir into very hot water (70 - 80 °C).
Mix well.
Centrifuge for 10 mins at 4200 rpm.
Discard the supernatant, mix into very hot water and centrifuge for 10 mins at 4200 rpm.
Perform the operation a third time.
Place the calibrated centrifuge crucible containing the centrifugation pellet in an oven at 105 °C to constant weight and weigh it. M2 is the weight of the washed and dried hulls which make up the insoluble DM

4 – CALCULATIONS

Percentage of insoluble dry matter

$$\% \text{ insoluble DM} = (M2/M1) \times 100$$

ZEOLITE Y-FAUJASITE

OIV-OENO 506/2016

1. OBJECT, ORIGIN AND FIELD OF APPLICATION

Zeolite Y-Faujasite is synthesized from alumina sources such as sodium aluminate and silica sources such as sodium silicate.

Zeolite Y-Faujasite incorporated in depth filtration filter sheets play an important role in simultaneously clarifying and selectively removing taint molecules which alter wine flavours

2. CHARACTERISTICS

Zeolite Y-Faujasite for selectively removing taint molecules, such as tricholoanisole, are characterized by having a silica-to-alumina ratio of 3 or higher. The negative charges of the framework are balanced by the positive charges of cations in non-framework positions.

3. TEST TRIALS

3.1 Loss on drying

Put 5g of Zeolite Y-Faujasite in a capsule. Heat in an oven to $120 \pm 2^\circ\text{C}$. After two hours, the mass loss should be smaller than 5%.

3.2 Odour and taste

Put 2.5 g of Zeolite Y-Faujasite in 1 L of wine. Leave standing for 24h. Compare the taste (for example with the duo-trio test or refer to the sensorial analysis document of the OIV) of the test wine to wine not containing any zeolite.

The test can also be carried out using filter sheets with Zeolite Y-Faujasite preconditioned according to the manufacturer usage instructions. Compare the taste of the filtered wine to wine filtered through standard depth filtration sheets not containing any specific zeolite.

The Zeolite Y-Faujasite should not impart any foreign odour or taste to the wine.

3.3 pH

Mix 1g of specific Zeolite Y-Faujasite in 40 mL of deionized water and shake for 20 minutes. After 5 minutes of rest, the pH of the supernatant is between 5 and 7.

3.4 Metal contents3.4.1 Test solution preparation

Slowly add tartaric acid to 1 litre of deionized water until a pH of 3 is reached. Into a 500 ml flask with a large neck which can be hermetically sealed, add 500 ml of the tartaric acid solution. Weigh 10g of dried specific Zeolite Y-Faujasite and sprinkle the sample in the constantly stirred solution. After this addition, shake vigorously for 5 minutes. Allow to stand for 24 to 48 hours. Decant, centrifuge, or filter if necessary to obtain at least 200 ml of clear liquid.

3.4.2 Arsenic

In the test solution obtained following the procedure in 3.4.1, determine Arsenic using an atomic absorption spectrometer, according to the method described in chapter II of the *International Oenological Codex*. Arsenic content must be less than 0.3 mg/kg specific Zeolite Y-Faujasite.

3.4.3 Cadmium

In the test solution obtained following the procedure in 3.4.1, determine Cadmium using an atomic absorption spectrometer, according to the method described in chapter II of the *International Oenological Codex*. Cadmium content must be less than 0.3 mg/kg specific Zeolite Y-Faujasite.

3.4.4 Chromium

In the test solution obtained following the procedure in 3.4.1, determine Chromium using an atomic absorption spectrometer according to the method described in Chapter II of the *International Oenological Codex*. Chromium content must be less than 0.3 mg/kg specific Zeolite Y-Faujasite.

3.4.5 Copper

In the test solution obtained following the procedure in 3.4.1, determine Copper using an atomic absorption spectrometer, according to the method described in chapter II of the *International Oenological Codex*. Copper content must be less than 0.3 mg/kg specific Zeolite Y-Faujasite.

3.4.6 Iron

In the test solution obtained following the procedure in 3.4.1, determine Iron using an atomic absorption spectrometer, according to the method described in chapter II of the *International Oenological Codex*. Iron

content must be less than 3 mg/kg specific Zeolite Y-Faujasite.

3.4.7 Lead

In the test solution obtained following the procedure in 3.4.1, determine Lead using an atomic absorption spectrometer, according to the method described in chapter II of the *International Oenological Codex*. Lead content must be less than 0.3 mg/kg specific Zeolite Y-Faujasite.

3.4.8 Manganese

In the test solution obtained following the procedure in 3.4.1, determine Manganese using an atomic absorption spectrometer. Manganese content must be less than 0.3 mg/kg specific Zeolite Y-Faujasite.

3.4.9 Mercury

In the test solution obtained following the procedure in 3.4.1, determine Mercury using an atomic absorption spectrometer, according to the method described in chapter II of the *International Oenological Codex*. Mercury content must be less than 0.1 mg/kg specific Zeolite Y-Faujasite.

3.4.10 Selenium

In the test solution obtained following the procedure in 3.4.1, determine Selenium using an atomic absorption spectrometer. Selenium content must be less than 1 mg/kg specific Zeolite Y-Faujasite.

3.4.11 Silver

In the test solution obtained following the procedure in 3.4.1, determine Silver using an atomic absorption spectrometer, according to the method described in chapter II of the *International Oenological Codex*. Silver content must be less than 0.3 mg/kg specific Zeolite Y-Faujasite.

3.4.12 Zinc

In the test solution obtained following the procedure in 3.4.1, determine Zinc using an atomic absorption spectrometer, according to the method described in chapter II of the *International Oenological Codex*. Zinc content must be less than 0.3 mg/kg specific Zeolite Y-Faujasite.

4. IDENTIFICATION

4.1 Efficacy testing

Efficacy testing of depth filtration pads containing Zeolite Y-Faujasite for the selective removal of 2,4,6 trichloroanisole (TCA) involves treating wine contaminated with 20 ng/L of 2,4,6 trichloroanisole (TCA). The pad is set in an appropriate filtration device and preconditioned by rinsing with clean water. After preconditioning, the contaminated wine is pushed through the filter pad at a rate of 15 litres, per meter squared of filtration area, per minute. Samples of the filtered wine are taken every ~235 litres per meters squared of filtration area. Each filtered wine sample is analysed using the GCMS. The TCA concentration data from each sampling event is then integrated to create a filter pad breakthrough curve.

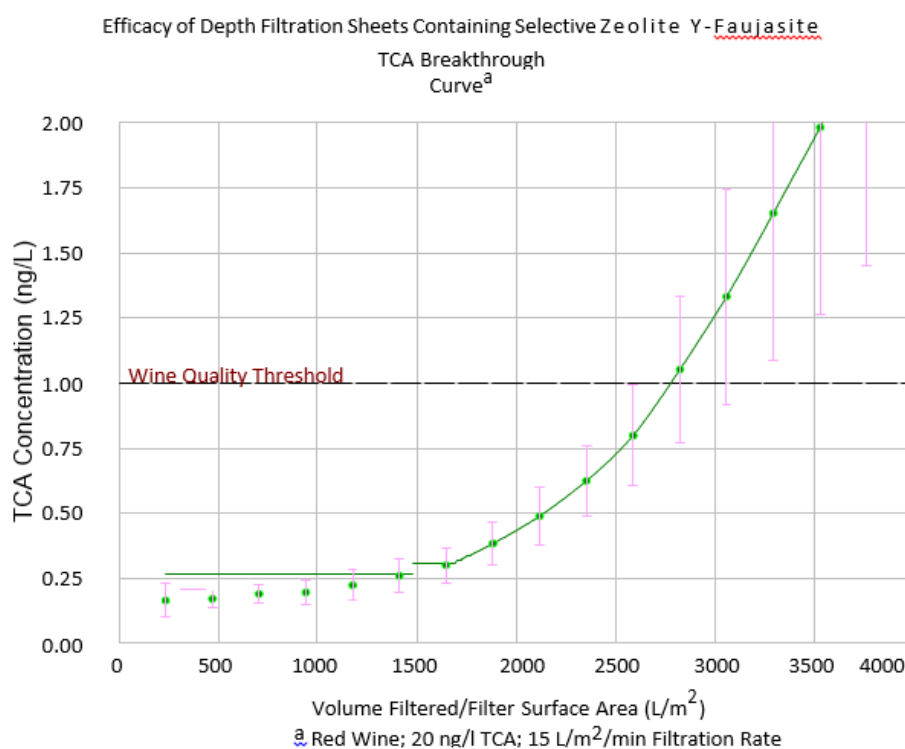

The breakthrough curve shown was generated using a number of commercial pads produced on various production dates.

5. STORAGE CONDITIONS

Selective filter sheets incorporating Zeolite Y-Faujasite should must be stored in their original packaging in an odourless, dry and ventilated environment

Appendix 1

Patent reference: WO 2007/061602 A1

Highly selective molecular confinement for the prevention and removal of taint in foods and beverages John Cunningham.

Chapter II
Analytical and
Control Techniques

DETERMINATION OF 5-(HYDROXYMETHYL)FURFURAL
OENO 18/2003

1. PRINCIPLE

The 5-(hydroxymethyl)furfural (HMF) is determined by HPLC (sharving liquid chromatography in reverse phase).

2. APPARATUS AND SOLUTIONS

2.1 Instrumental parameters (for example)

Chromatograph in liquid phase
UV/visible detector
column: octadecyl type grafted silica (C18), (length: 20 cm; internal diameter: 4.6 mm; granulometry of phase: 5 µm)
mobile phase: ultra filtered demineralised water - methanol - acetic acid (80, 10, 3: v/v/v)
flow: 0.5 ml/mn
detection wave length: 280 nm
injected volume: 20 µl

2.2 Preparation of calibration solutions

Solution HMF at 20 mg/l:
In a 100 ml graduated flask, introduce 20 mg of HMF weighed within 0.1 mg and complete to the graduated line with ultra filtered demineralised water, introduce 10 ml of this solution in a 100ml graduated flask and complete with ultra filtered demineralised water; the solution HMF at 20 mg/l is to be prepared each day.

3. PREPARATION OF SAMPLES

The samples and the calibration solution HMF are injected after filtration on a 0.45 µm membrane.

4. PROCEDURE

The chromatographic column is stabilised with the mobile phase for about 30 min.

Calculate the concentration of HMF of the sample from the peak surfaces.

**MEASURING ARSENIC BY HYDRIDE GENERATION
AND ATOMIC ABSORPTION SPECTROMETRY**

OENO 18/2003

1 – FIELD OF APPLICATION

This method applies to the analysis of arsenic in the concentration range of 0 to 200 µg/l with prior mineralisation for oenological products.

2 – DESCRIPTION OF THE TECHNIQUE

2.1. Principle of the method

After reducing arsenic (V) into arsenic (III), arsenic is determined by hydride generation and atomic absorption spectrometry.

2.2. Principle of the analysis (figure n°1)

The peristaltic pump draws up the borohydride solution, hydrochloric acid solution and calibration or sample.

The hydride formed in the gas-liquid separator is entrained by a neutral gas (argon).

The gaseous current passes in a dessicator made up of calcium chloride.

The arsenic hydride is analysed in an quartz absorption cell in the flame of a air-acetylene burner.

The optical path of the hollow-cathode lamp of the atomic absorption spectrometer passes in the quartz cell.

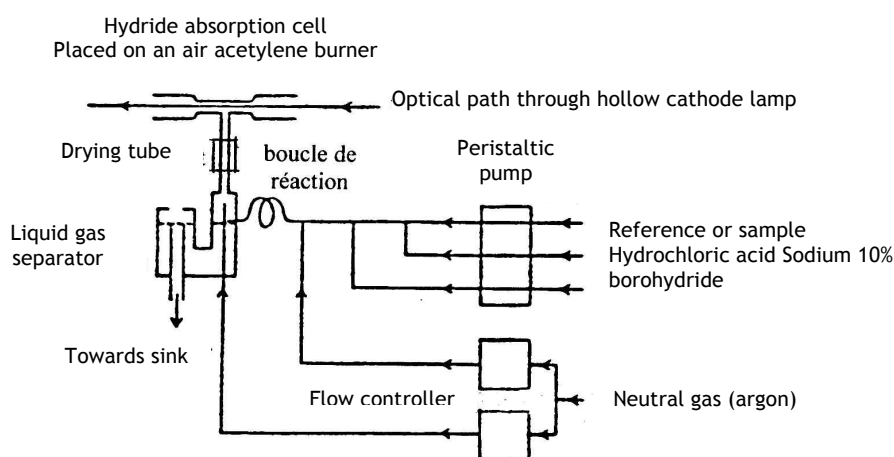

Figure n°1. Hydride generator

3 – REAGENTS AND PREPARATION OF REAGENT SOLUTIONS

3.1. Ultra-pure demineralised water

3.2. Ultra-pure nitric acid at 65%

3.3. Potassium iodide KI

3.4. Potassium iodide at 10% (m/v)

3.5. Concentrated hydrochloric acid

3.6. Hydrochloric acid at 10% (m/v)

3.7. Sodium borohydride NaBH₄

3.8. Sodium hydroxide NaOH in patches

3.9. Sodium borohydride solution at 0.6% (containing 0.5% of NaOH)

3.10. Calcium chloride CaCl₂ (used as a dessicator)

3.11. Silicone annular

3.12. Arsenic calibration solution at 1 g/l containing 2% of nitric acid and prepared from the following acid: H₃AsO₄½ H₂O

3.13. Arsenic solution at 10 mg/l: place 1 ml of the calibration solution (3.12.) in a 100 ml flask; add 1% of nitric acid (3.2.); complete to volume with demineralised water (3.1.).

3.14. Arsenic solution at 100 µg/l: place 1 ml of the arsenic solution at 10 mg/l (3.13.) in a 100 ml flask; add 1% of nitric acid (3.2.); complete to volume with demineralised water (3.1.).

4 – APPARATUS

4.1. Glassware:

- 4.1.1. graduated flasks 50 and 100 ml (class A)
- 4.1.2. graduated pipettes 1, 5, 10 and 25 ml (class A)
- 4.1.3. cylindrical vases 100 ml

4.2. Hot plate with thermostat**4.3. Ashless filter paper****4.4. Atomic absorption spectrophotometer:**

- 4.4.1. air-acetylene burner
- 4.4.2. hollow-cathode lamp (arsenic)
- 4.4.3. deuterium lamp

4.5. Accessories:

- 4.5.1. vapour generator (or gas-liquid separator)
- 4.5.2. quartz absorption cell placed on the air-acetylene burner
- 4.5.3. bottle of neutral gas (argon)

5 – PREPARATION OF THE SET OF CALIBRATION SOLUTIONS AND SAMPLES**5.1. Set of calibration solutions 0, 5, 10, 25 µg/l**

Place successively 0, 5, 10, 25 ml of the arsenic solution at 100 µg/l (3.14.) in 4, 100 ml flasks; add to each flask 10 ml potassium iodide at 10% (3.4.) and 10 ml of concentrated hydrochloric acid (3.5.); complete to volume with demineralised water (3.1.); allow to stand at room temperature for one hour.

5.2. Samples of oenological products

The sample is mineralised by wet process (cf. mineralisation methods of samples before determination by atomic absorption spectrometry) then filtered. Transfer 10 ml of filtered mineralisate to a 50 ml flask; add 5 ml of potassium iodide at 10% (3.4.) and 5 ml of concentrated hydrochloric acid (3.5.); add a drop of anti-foam (3.11.); adjust to volume with demineralised water (3.1.). Allow to stand at room temperature for one hour. Filter on an ashless filter paper.

6. PROCEDURE**6.1. Instrumental parameters of the atomic absorption spectrophotometer** (given as an example)

- 6.1.1. oxidant air-acetylene flame

- 6.1.2. wave length: 193.7 nm
- 6.1.3. width of the monochromator's slit: 1.0 nm
- 6.1.4. intensity of the hollow-cathode lamp: 7 mA
- 6.1.5. correction of the non specific absorption with a deuterium lamp

6.2. Analytical determination

The peristaltic pump draws up the reagent solutions (3.6.) and (3.9.) and the calibrations or samples (5.1.) or (5.2).

Present successively the calibration solutions (5.1.); wait long enough so that the hydride formed in the gas-liquid separator, passes in the absorption cell; perform an absorbance reading for 10 seconds; perform two measurements; the spectrometer's computer software sets up the calibration curve (absorbance depending on the concentration of arsenic in µg/l).

Then present the samples (5.2.). Perform two measurements.

6.3. Self-check

Every five determinations, an analytical blank solution and a calibration are analysed in order to correct a possible deviation of the spectrometer.

7. EXPRESSION OF RESULTS

The results are directly printed by the printer connected to the computer.

The concentration of arsenic in oenological products is expressed in µg/kg while taking into account the test sample.

8. CONTROL OF RESULTS

The quality control is performed by placing, after the set of calibration solutions and every five samples, a reference material whose content in arsenic is known with certainty.

A control card is set up for each reference material used. The control limits were set at: $\pm 2S_R$ intra (S_R intra : standard deviation of reproductibility).

9. BIBLIOGRAPHY

10.1. PESQUE M., 1982. Dosage de l'arsenic dans le vin. Rapport de stage. Diplôme d'œnologie. Institut d'œnologie de Bordeaux.

10.2. GAYE J., MEDINA B., 1998. Dosage de l'arsenic dans le vin par spectrométrie d'absorption atomique. Feuille Vert de l'O.I.V. n°1069.

10.3. GAYE J., MEDINA B., 1999. Arsenic dans les vins. Feuille Vert de l'O.I.V. n°1087.

**METHODS OF MICROBIOLOGICAL ANALYSIS
BACTERIOLOGICAL CONTROL
ANALYSIS COMMON TO ALL MONOGRAPHS**

AG 4/82-OEN;
OENO 16/2003;
OENO 17/2003;
OIV/OENO 328/2009;
OIV/OENO 329/2009;
OIV-OENO 632-2021

1. Preliminary rehydration of yeasts (*Saccharomyces* and non-*Saccharomyces*): ADY (Active Dry Yeasts), AFY (Active Frozen Yeasts), COY (Compressed Yeasts), CRY (Cream Yeast Preparations), ENY (Encapsulated [beads] or Immobilised Yeasts), "levain de tirage" (yeast starter for tirage)

Weigh approx. 10 g of the preparation under sterile conditions (note the exact weight for final calculation of the concentration).

Adjust to 100 mL with sterile peptone saline water* under sterile conditions at 20-37 °C or according to the manufacturer's recommendations.

Slowly homogenise using a rod, a stomacher technique or a magnetic stirrer for 5 min.

Stop stirring and allow to stand for 20 min at room temperature of between 20-30 °C.

Homogenise again at room temperature for 5 min.

Under sterile conditions, prepare serial decimal dilutions in water or sterile peptone saline water* and proceed with microbiological controls on the homogenised stock solution.

In the case of "levains de tirage" used for sparkling wines, sample 1 mL under sterile conditions, prepare serial decimal dilutions in water or sterile peptone saline water* and proceed with microbiological controls on the homogenised stock solution

* Peptone salt solution: bacteriological peptone 1 g/L, sodium chloride 8.5 g/L, final pH 7.0

2. Preliminary rehydration of preparations of lactic acid bacteria

Weigh approx. 10 g of preparation of lactic acid bacteria under sterile conditions (note the exact weight for final calculation of the concentration).

Adjust to 100 mL with sterile peptone saline water* under sterile conditions (25 °C).

Homogenise using a magnetic stirrer or a stomacher technique for 5 min.
Stop stirring and allow to stand for 20 min at room temperature of between 20-30 °C.

Homogenise again at room temperature for 5 min.

Under sterile conditions, prepare serial decimal dilutions using water or sterile peptone saline water* and proceed with microbiological controls.

* Peptone salt solution: bacteriological peptone 1 g/L, sodium chloride 8.5 g/L, final pH 7.0

3. Microbiological control of other products in the International Oenological Codex

(products for which the control of yeasts, bacteria and/or moulds is requested)

Weigh approx. 10 g of the oenological product to control under sterile conditions (note the exact weight for final calculation of the concentration).

Adjust to 100 mL with sterile peptone saline water* under sterile conditions.

Homogenise using a magnetic stirrer or a stomacher technique for 5 min.

Under sterile conditions, prepare serial decimal dilutions in water or sterile peptone saline water* and proceed with microbiological controls.

* Peptone salt solution: bacteriological peptone 1 g/L, sodium chloride 8.5 g/L, final pH 7.0

4. Enumeration of total yeasts

YM agar medium (MALT WICKERHAM)

Bacteriological agar	15 g
Yeast extract	3 g
Malt extract	3 g
Peptone	5 g
Glucose	10 g
Water	q.s. 1000 mL

YPD

Yeast extract	10 g
Peptone	20 g
Glucose	20 g
Agar	10 g
Water	q.s. 1000 mL

Just after preparation, autoclave the medium at 120 °C for 20 min.

In case of prolonged incubation time, add chloramphenicol to a 100 mg/L final concentration to prevent bacterial growth.

After inoculation with the appropriate dilutions of the sample in order to reach 30-300 colonies, incubate the dishes at 25-30 °C under aerobic conditions for 48 to 72 hours.

Count the number of CFU in the dishes containing 30-300 colonies and refer to the weight of the dry matter.

In addition to the media proposed, any equivalent medium internationally recognised for growth of these microorganisms may be used.

5. Enumeration of non-*Saccharomyces* yeasts

5.1. Lysine medium

The yeasts are cultivated in the lysine medium whose composition is as follows:

Agar	20 g
L-lysine monohydrochloride	5 g
Glucose	1 g
Bromocresol purple	0.015 g
Water	q.s. 1000 mL
Adjust to	pH 6.8 ± 0.2

Bring to the boil for 1 min to ensure complete dissolution, then autoclave at 120 °C for 20 min.

In case of prolonged incubation time, add chloramphenicol to a 100 mg/L final concentration to prevent bacterial growth.

After inoculation with the dilutions of the sample, the dishes are incubated at 25 °C or 30 °C for 48 to 96 hours.

Count the number of CFU (dishes of 30-300 colonies) and refer to the weight of the dry matter.

In addition to the media proposed, any equivalent medium internationally recognised for growth of these microorganisms may be used.

5.2. YPD medium with addition of cycloheximide at 10 mg/L, and incubation for 6-7 days under aerobic conditions

In case of prolonged incubation time, add chloramphenicol to a 100 mg/L final concentration to prevent bacterial growth.

6. Enumeration of viable lactic acid bacteria**Modified MRS (Man, Rogosa and Sharpe)**

The bacteria are cultivated in a MRS medium (Man, Rogosa, Sharpe 1960), with addition of tomato juice, and the composition is as follows:

Agar agar	15 g
Bacto-peptone	10 g
Meat extract	8 g
Yeast extract	4 g
Sodium acetate	5 g
K ₂ HPO ₄	2 g
Trisodium citrate	2 g
MgSO ₄ at 100 mg/L	2.5 mL
MnSO ₄ at 20 mg/L	2 mL
Tween 80	1 mL
DL malic acid	5 g
Tomato juice*	200 mL
Glucose 20 g, or glucose 10 g +fructose 10 g	
Adjust (HCl or NaOH) q.s. pH	4.8
Distilled water q.s.	1000 mL

(q.s. = quantity sufficient)

*Tomato juice is used to improve lactic bacterial growth. Preparation: take commercial (without additives) or homemade tomato juice, centrifuge at 4000*g* for 20 min, filter if necessary and use the clear juice.

Autoclave at 110 °C for 20 min.

When pouring the medium into the Petri dish, add pimaricine to a 10 mg/L final concentration to inhibit the growth of yeast and mould.

Incubate at 25 °C under anaerobic conditions for 8 to 10 days.

In addition to the media proposed, any equivalent medium internationally recognised for growth of these microorganisms may be used.

7. Enumeration of mould

Czapeck-Dox/s agar medium

Agar agar	15 g
Saccharose	30 g
NaNO ₃	3 g

K ₂ HPO ₄	1 g
MgSO ₄	0.5 g
KCl	0.5 g
FeSO ₄	0.01 g
Water	q.s. 1000 mL

Adjust to pH 7

Autoclave at 120 °C for 20 min.

Add chloramphenicol directly to the medium in the Petri dish to a 100 mg/L final concentration to inhibit the growth of bacteria.

Incubate at 20 °C under aerobic conditions for 10 days.

In addition to the media proposed, any equivalent medium internationally recognised for growth of these microorganisms may be used.

8. Enumeration of acetic bacteria

Bacteriological agar	20 g
Yeast extract	5 g
Casein amino acids	5 g
Glucose	10 g
Adjust to	pH 4.5
Water	q.s. 1000 mL

Autoclave at 120 °C for 20 min.

When pouring the medium into the Petri dish, add pimarcine to a 100 mg/L final concentration, to inhibit the growth of yeast and mould, and penicillin to a 12.5 mg/L final concentration to inhibit the growth of lactic acid bacteria.

Incubate at 25 °C under aerobic conditions for 4 days.

In addition to the media proposed, any equivalent medium internationally recognised for growth of these microorganisms may be used.

9. Count of Salmonella

9.1. Principle

The sample undergoes a pre-enrichment phase in peptoned buffered water for 16 to 20 hours at 37°C. Then the aliquot part of this mixture is inoculated for culture.

This contains a specific medium and 2 special tubes (made up of 2 parts) and is incubated 24 hours at 41°C. *Salmonella* migrates from the bottom (selective medium) to the top part of the tube (indicator medium). The presence of *Salmonella* is indicated by a change in colour of this solution.

9.2. Apparatus and analytical conditions

Preparation for culture is carried out in the sterile zone ensured by the Bunsen burner. The soiled material is submitted for destruction by autoclave for 1 hour at 120°C or by total immersion in a bleaching agent for at least 18 hours (See cleaning procedure).

- Sterile glass test tube in 125 ml
- Sterile stomacher bag
- Closing Barrette
- Stomacher
- Sterile glass tubes 16x160 mm.
- Cottoned glass test tubes 20x220
- 2 ml sterile plastic pipettes graduated by 0.1 ml
- 10 ml sterile plastic pipettes graduated by 0.1 ml
- Tube shaker

Method for culture to be rehydrated.

2 ml sterile needle with plastic sterile syringe.

- Tweezer forceps
- Wrench for unscrewing tubes A and B for culture method
- Clean glass slide
- Sterile cottoned Pasteur pipettes
- Monosaccharide
- Oven at 41°C ± 1°C
- Oven at 37°C ± 1°C
- Bunsen burner

9.3. Reagents

- Sterile peptoned water (SPW)
- Sterile distilled water (SDW)
- Sterile 500 ml sealed flask filled with 125 ml of SPW
- Sterile 500 ml sealed flask filled with 225 ml of SPW
- Special medium for *Salmonella*: SRTEM
- Novobiocin disk (1.8 mg of novobiocin)
- Hektoën agar agar (see DOMIC-08)

API 20E gallery
Agar agar tubes TSAYE inclined
Sterile NaCl at 8.5 g/l solution
Anti-*Salmonella* serum

9.4. Procedure

9.4.1 Preparation of reference suspension

This differs according to nature of products and dilution rate.

Add a test portion of 25 grams or millilitres of the product in a stomacher bag to a nine fold greater amount of peptoned water.

Close the bag by heat welding or using a barrette.

Grind in a stomacher for 1 minute.

9.4.1.1 Pre-enrichment phase in a non selective liquid medium:

Incubate the reference suspension for 16 to 20 hours at $37^{\circ}\text{C} \pm 1^{\circ}\text{C}$.

9.4.1.2 Enrichment in selected liquid mediums

Preparation of culture measures

- unscrew the lid of the culture container;
- add SDW up to line 1 as marked on the container.

Note: The base of tubes A and B must be located under water level.

- adjust the needle to the syringe and check that the syringe plunger is pushed in (absence of air);
- vertically introduce the needle to the syringe in the rubber disc in the centre of the stopper in tube A (blue stopper). Check that the needle is visible under the stopper;
- carefully withdraw the syringe up until the liquid reaches line 3 on the container.

Note: Do not draw up liquid into the syringe.

This operation should take approximately 5 seconds.

- Repeat this operation with tube B (red stopper);
- Close the stopper from the culture container tightly;
- Press the side of the recipient on a tube shaker and maintain at least 5 seconds.

Note: the liquid in tubes A and B must be shaken vigorously.

- Let the culture at least 5 minutes;

- Unscrew the culture container's stopper and pour in the SRTEM medium until the level reaches line 2 as marked on the container;
- Add a novobiocin disc using a tweezer forceps;
- Remove the stoppers from tubes A (blue) and B (red) using a wrench, then dispose of the stoppers.

Note: avoid touching the tubes and the inside wall of the container. Inoculation of culture container

- Homogenise the pre-enriched culture;
- Identify the culture container. Write down the analysis number on the lid.
- Unscrew the lid.
- Using a 2 ml pipette introduce 1 ml of pre-enriched culture in the culture container.
- Tighten the lid on the culture container.
- Write down the incubation time and date.
- Incubate 24 hours \pm 30 min at 41°C \pm 1°C in a strictly vertical position.

9.4.2 Reading and interpretation

This is carried out by observing the top part of tubes A and B through the container walls.

REACTION	TUBE A	TUBE B
Positive :	All degrees of black colouring	All degrees of red or black colouring
Negative :	Absence of black colouring	Absence of red or black colouring

The possible presence of *Salmonella* is characterised by modifications in indicator medium colour located in one or both of the top parts of the tubes:

Tubes showing a positive reaction are subjected to selective agar isolation.

- Dry boxes of Hektoën agar in an incubator at 46°C \pm 1°C until the drops on the surface of the medium disappear completely (lid removed and agar surface facing down).

- Take a wire hoop from the positive middle indicator and inoculate it into 5 ml of SPW, in a 16x160 mm sterile glass tube in order to dilute the culture.
- Proceed as such with each positive tube.
- Identify the dish and write down on the lid the number of the analysis and the letter of the tube being confirmed.
- Homogenise the culture and take a wire hoop.
- Isolate the Hektoën agar on the surface to enable the development of isolated colonies.
- Incubate 24 hours at 37°C ± 1°C.
- Select at least 2 isolated colonies considered to be typical.

9.4.3. Confirmation

9.4.3.1 Biochemical tests

- Identify the different colonies by using specific miniaturised galleries (API 20^E gallery) by referring to the recommendations of the manufacturer.
- Incubate 24 hours at 37°C ± 1°C.
- At the same time inoculate: an agar to confirm the purity of the strain.
1 agar TSAYE inclined for serological typing.
- Incubate 24 hours at 37°C ± 1°C.
- Read the API20E gallery following the manufacturer's indications.
- Compare the profile obtained to the standard profiles given by the manufacturer.
- Store TSAYE agar in the refrigerator until utilisation.

9.4.3.2 Serological tests:

Tests are conducted if the strain profile corresponds to *Salmonella* following the recommendations defined by the manufacturer from cultures obtained on agar and after eliminating self-agglutinating strains.

Elimination of self-agglutinating strains:

- Place a drop of 8.5 g/l saline solution on a perfectly clean glass slide.
- Disperse a little bit of the culture removed from the nutritive agar to obtain a homogeneous and cloudy solution using a Pasteur pipette.
- Oscillate the slide for 30 to 60 seconds.
- On a black background using a magnifying glass: if any observation reveals more or less distinct clusters, the strain is considered as being self-agglutinating and should not be subjected to serological typing.

9.5. Results

According to the results based on the interpretation of biochemical and serological testing, the results are expressed as follows:

- Presence of *Salmonella* in m number of grams or ml of product.
- Absence of *Salmonella* in m number of grams or ml of product.

Diagram of procedures

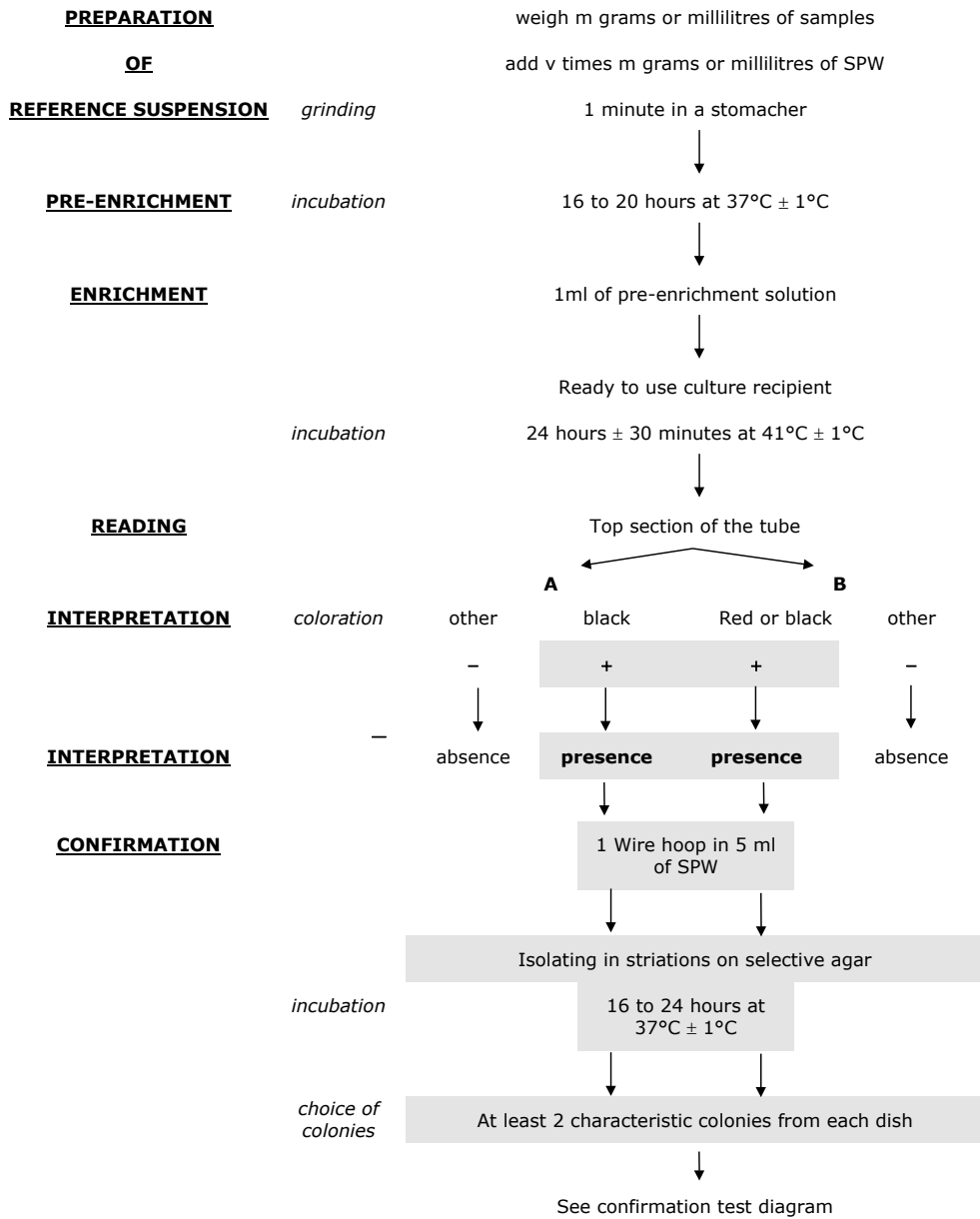

Test confirmation diagram

CHOICE OF COLONIES

PURIFICATION

incubation

BIOCHEMICAL IDENTIFICATION

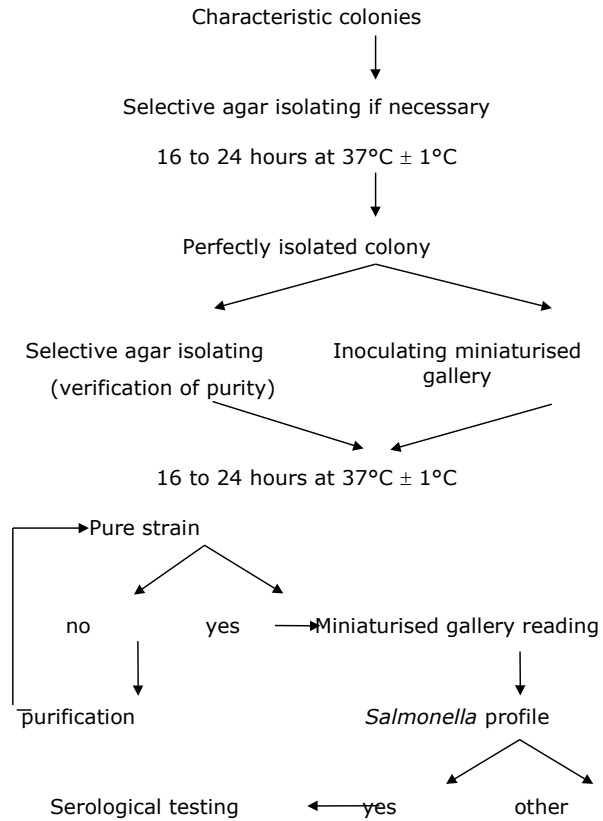

SEROLOGICAL IDENTIFICATION

subculture

On inclined TSAYE agar

serology

- 1 tube for serology

absence of auto-agglutination and antigen agglutination O:

Salmonella

Diagram of biochemical and serological interpretations

Biochemical reactions	Self-agglutination	Serological reactions	Interpretation
Typical	no	"O" positive antigen	<i>Salmonella</i>
Typical	no	Negative reactions	Sent to an authorised centre
Typical	yes	Not carried out	for determination of the serological type

10. Count of *Escherichia coli* by the counting of colonies obtained at 44°C**10.1. Principle**

Inoculating rapid E. coli agar in depth is carried out in a Petri dish for each of the dilutions chosen. Following a 24 hour incubation at 44°C, all characteristic colonies which appear are counted.

10.2. Apparatus and analytical conditions

Cultures are carried out in a sterility zone ensured by the usage of a Bunsen burner.

Plastic sterile Petri dishes with a diameter of 90 millimetres
Sterile 16x60 cottoned glass test tubes
Tube holder
2 ml plastic sterile pipettes with 0.1 ml graduations
Water bath at 100°C ± 2°C
Water bath at 47°C ± 2°C
Tube shaker
Oven at 44°C ± 1°C
Bunsen burner
Colony counter

10.3. Reagents

Sterile diluent for decimal dilutions: tryptone salt (TS)
16x160 pre-filled sterile tubes with 9ml of sterile TS
Rapid'E.coli cooling agar (R.E.C)

10.4. Procédure

- 10.4.1 Bacteriological agar medium
- Melt R.EC agar in a boiling water bath. Avoid overheating.
 - Never use a culture medium above 50°C.
 - For immediate usage, keep agar in the water bath at 47°C ± 2°C.
 - Do not cool over 8 hours.
 - For a deferred usage maintain the cooling agar in an oven at 55°C ± 1°C.
 - The melted culture medium not used within 8 hours will not re-solidify for another usage.

10.4.2 Culture

- Homogenise each dilution before inoculation in Petri dishes and before carrying out decimal dilutions.
- Transfer 1 ml from the reference solution and/or the retained decimal dilutions in the respective Petri dishes. Change the pipette after each dilution.
- Introduce at least 20 minutes after inoculum, 15 to 20 ml of R.EC maintained in the water bath at $47^{\circ}\text{C} \pm 2^{\circ}\text{C}$.
- Slowly homogenise by shaking.
- Let solidify on the bench (lid up).
- Pour 4 to 5 ml of R.EC maintained at $47^{\circ}\text{C} \pm 2^{\circ}\text{C}$.
- Let solidify on a bench (lid up).
- Return the dishes and incubate in an oven 24 hours \pm 2 hours at $44^{\circ}\text{C} \pm 1^{\circ}\text{C}$.

10.4.3 Count

Dishes containing between 15 and 150 characteristic colonies of two successive solutions are retained for counting.

If the dish inoculated with 1 ml of first dilution contains characteristic colonies and fewer than 15, it will be retained for counting.

Characteristic colonies are counted using a counter or are counted manually after 24 hours \pm 2 hours of incubation.

10.5 Results

10.5.1 General case

The dishes contain between 15 and 150 characteristic colonies for two successive dilutions.

10.5.1.1 Method of calculation

The two dishes retained have between 15 and 150 characteristic colonies. The number N of counted micro-organisms at 44.5°C per millilitre (ml) or by gram (g) of product is obtained by calculating the weighted mean on 2 dishes retained.

$$N = \frac{\sum c}{1,1d}$$

$\sum c$: sum of characteristics counted on 2 dishes retained

d : rate of dilution corresponding to first dilution

10.5.1.2 Expression of results

- Round off the number N to 2 significant digits
- Express to the tenth power
ex.: 1.6 10³ / g or ml

10.5.2 Estimation of small numbers

If the dish inoculated with 1 ml of the 1st retained solution for analysis contains at least 15 characteristic colonies, express the result as follows:

$$N = c \frac{1}{d}$$

c : sum of characteristic colonies counted
d : rate of dilution

If the dish inoculated with 1 ml of the 1st retained solution for analysis does not contain any colonies, express the result as follows:

$$N = < 1 \frac{1}{d} \text{ micro-organism per g or ml}$$

d : rate of dilution

11. Count of Staphylococci with a positive coagulase by the counting and confirmation of colonies obtained at 37°C**11.1. Principle**

Decimal dilutions and inoculation on the surface of 1 Baird Parker agar drawn previously in a Petri dish with each of the dilutions retained, are carried out simultaneously from the sample (liquid product) or from the reference solution (other products).

After an incubation of 48 hours at 37°C the characteristic and/or non characteristic colonies are counted and then confirmed by the coagulase test.

11.2. Apparatus and analytical conditions

Cultures are carried out in a sterility zone ensured by the usage of a Bunsen burner.

- Sterile glass 16x160 cottoned test tubes
- Sterile plastic precipitating tubes with plastic stoppers
- Tube holder
- 2 ml plastic sterile pipettes with 0.1 ml graduations
- Sterile plastic spreader
- Sterile Pasteur pipettes
- Tube shaker
- Incubate at 37°C ± 1°C
- Bunsen burner
- Colony counter

11.2.1 Reagents

- Sterile diluent for tryptone salt (TS) decimal dilutions.
- 16x160 sterile tubes pre-filled with 9ml of sterile TS.
- Baird Parker agar pre-poured in a Petri dish.
- Tubes pre-filled with 5ml brain heart bouillon (sterile).
- Plasma of lyophilised rabbit rehydrated at the time of use.

11.2.2 Procedure**11.2.2.1 Culture**

- Dry the agar plates in an incubator at 46°C ± 1°C until the droplets on the surface of the environment have completely disappeared (cover is removed and the agar surface is turned downwards).

- Homogenise each dilution prior to inoculation of the surface of agar plate surface before carrying out decimal dilutions.
- Place 0.1 ml of reference solution and/or the retained decimal dilutions on the agar surface while changing the pipette after each dilution.
- Carefully spread the inoculum as quickly as possible using a spreader without touching the edges of the plate.
- Leave the plates with the lids closed for 15 minutes at room temperature.
- Incubate 48 hours \pm 2 hours at 37°C \pm 1°C

11.2.2.2 Counting

Dishes containing less than 150 characteristic and/or non-characteristic colonies on two successive dilutions are retained, but one of them must include at least 15 colonies. The characteristic and/or non-characteristic colonies are counted either manually or by using a counter.

Characteristic colonies

after 48 hours \pm 2 hours of incubation:

- Black or grey, shiny or convex with at least a 1 mm in diameter and a maximum of 2.5 mm in diameter outlined with lightening and precipitation halos.

Non-characteristic colonies

after 48 hours \pm 2 hours of incubation:

- Black and shiny with or without a white edge with lightening or precipitation halos absent or barely visible.
- Grey without light zones.

11.2.2.3 Confirmation

Remove 3 characteristic colonies or 3 colonies of each type (characteristic or non-characteristic) and submit them to the coagulase test.

Coagulase test:

a) Bouillon culture:

- Take part of the selected colony using a Pasteur pipette sterilised with the Bunsen burner flame and inoculate into a brain heart bouillon.
- Repeat this manipulation for other selected colonies.

- Identify the tubes by sample number and its dilution with a blue marker for characteristic colonies and a green marker for non-characteristic colonies.
- Incubate at 37°C \pm 1°C for 20 to 24 hours \pm 2H.

b) Testing for free coagulase:

- Add 0.5 ml of culture obtained in brain heart bouillon to 0.5 ml of rehydrated rabbit plasma in a sterile precipitating tube and identify as follows.
- Repeat this procedure for each bouillon culture.
- Incubate 4 to 6 hours at $37^{\circ}\text{C} \pm 1^{\circ}\text{C}$.

- Check for the presence of coagulum or examine the tube after 24 hours \pm 2 hours of incubation.

11.2.3 Results

Coagulase is considered positive when it occupies $\frac{3}{4}$ of the initial volume of the liquid.

11.2.3.1 General case

The plates contain a maximum of 150 characteristic and/or non-characteristic colonies.

Calculation procedure:

- *Number of Staphylococci with positive coagulase for each plate: a*

$$a = \frac{b^c}{A^c} \times c^c + \frac{b^{nc}}{A^{nc}} \times c^{nc}$$

A^c is the number of spotted characteristic colonies

A^{nc} is the number of spotted non-characteristic colonies;

b^c is the number of characteristic colonies of positive Staphylococci coagulase;

b^{nc} is the number of non-characteristic colonies of positive coagulase Staphylococci

c^c Is the total number of characteristic colonies of positive coagulase Staphylococci for the plate retained;

c^{nc} Is the total number of non-characteristic colonies of positive coagulase Staphylococci positive for the plate

retained.

Round off the number to the nearest whole number.

- *Number of positive coagulase Staphylococci in trials: N*

The weighted average, calculated as follows from two successive retained solutions:

$$N = \frac{\sum a}{1,1 \times F} \times 10 \text{ positive coagulase Staphylococci by g or ml}$$

$\sum a$: sum of positive coagulase Staphylococci colonies identified on 2 retained plates

F : rate of dilution corresponding to the 1st retained dilution.

Expression of results:

- round off the number N to the two largest whole digits
- express to the tenth power

ex.:	Amount obtained	Amount rounded off	Result
	36364	36000	3.6 10 ⁴

11.2.3.2 Estimation of small numbers:

If the plate inoculated with 0.1 ml of the first dilution retained for analysis contains less than 15 colonies, the result will be expressed as follows:

$$N = a \frac{1}{d} \times 10 \text{ positive coagulase Staphylococci per g or ml}$$

a : number of positive coagulase Staphylococci identified.

d : rate of dilution for the first dilution retained for analyse.

If the dish inoculated with 0.1 ml of the first dilution retained for analysis contains no positive coagulase Staphylococci the result shall be expressed as follows:

$$N < \frac{1}{d} \times 10 \text{ no positive coagulase Staphylococci per g or ml}$$

d : Rate of dilution from the first retained dilution for analysis.

12. Coliform count by counting colonies obtained at 30°C

12.1. Principle

Inoculation in deeply in crystal violet to neutral red (VRBL) lactose bile agar was carried out in Petri dishes for each of the dilutions retained. After incubation for 24 hours at 30°C, the characteristic colonies were counted.

12.2. Apparatus and analytical conditions

Cultures are carried out in a sterile environment as ensured by a Bunsen burner.

- Plastic sterile Petri dishes with a diameter of 90 millimetres
- Sterile glass 16 x 160 cottoned tubes
- Tube holder
- 2 ml plastic sterile pipettes graduated at 0.1 ml
- Water bath at 47°C ± 2°C.
- Tube shaker
- Incubate at 30°C ± 1°C
- Incubate at 55°C ± 1°C
- Bunsen burner
- Colony counter

12.3. Reagents

- Sterile diluent for decimal dilutions: tryptone salt (TS)
- 16 × 160 sterile tubes pre filled with 9ml of sterile TS
- Cooled crystal violet and neutral red lactose bile agar (VRBL).

12.4. Procedure

12.4.1 Agar medium

- Once prepared, keep the VRBL agar cooled in the water bath at 47°C ± 2°C (for immediate usage).
- Never use a culture medium at a temperature higher than 50°C.
- Do not cool over 8 hours.
- For a deferred usage, keep agar cooled in an incubator at 55°C ± 1°C.

- Melted culture mediums unused within 8 hours, shall never re-solidify for later usage.

12.4.2 Culture

- Homogenise each dilution before inoculating in Petri dishes prior to carrying out decimal dilutions.
- Transfer 1 ml of reference solution and/or decimal dilutions retained in respective Petri dishes with pipettes changed after each dilution
- Introduce up to 20 minutes after the inoculum 15 to 20 ml of VRBL maintained in the water bath at $47^{\circ}\text{C} \pm 2^{\circ}\text{C}$.
- Slowly homogenise by shaking.
- Let solidify on laboratory bench (lid upwards).
- Pour approximately 5 ml of VRBL maintained in the water bath at $47^{\circ}\text{C} \pm 2^{\circ}\text{C}$.
- Let solidify on laboratory bench (lid upwards).
- Turn over dishes and incubate immediately 24 hours \pm 2 hours at $30^{\circ}\text{C} \pm 1^{\circ}\text{C}$.

12.4.3 Count

Dishes containing less than 150 characteristic or non-characteristic colonies based on two successive dilution are retained, but one of them must contain at least 15 characteristic colonies.

If only the dish inoculated with 1 ml of the 1st dilution contains under 15 characteristic colonies, then the dish will be retained for counting.

Characteristic colonies are counted manually or by using a counter.

Characteristic colonies after 24 hours \pm 2 hours of incubation

- violet colonies surrounded sometimes by a red area (bile precipitation)
- diameter ≥ 0.5 mm

12.5. Results

12.5.1 General case

Dishes containing less than 150 characteristic or non-characteristic colonies, based on two successive dilutions with one containing at least 15 characteristic colonies.

Method of calculation:

Number N of micro-organisms counted at 30°C per millilitre (ml) or by gram (g) of product is obtained by calculating the weighted average of 2 retained dishes.

$$N = \frac{\sum c}{1,1d}$$

$\sum c$: sum of characteristic colonies counted of 2 retained dishes

d : dilution rate corresponding to the 1st dilution

Expression of results:

- round off the number N to the 2 largest digits
 - express to the tenth power
- ex: 1.6 10³ / g or ml

12.5.2 Estimation of small numbers

If the dish inoculated with 1 ml of the 1st dilution retained for analysis contains less than 15 characteristic colonies, the result will be expressed as follows:

$$N = c \frac{1}{d}$$

c : sum of characteristic colonies counted

d : rate of dilution

If the dish inoculated with 1ml of the 1st dilution retained for analysis contains no colonies then the result will be expressed as follows:

$$N = < 1 \frac{1}{d} \text{ micro-organisms per g or ml}$$

d : rate of dilution.

ANNEX 1

REVIEW OF METHODS OF COLIFORM RESEARCH
Escherichia coli and *Staphylococcus***SELECTIVE-DIFFERENTIAL MEDIUM FOR COLIFORMS. DESOXYCOLATE AGAR****Ingredients/l**

Peptone	10.0 g	
Lactose	10.0 g	
Sodium desoxycolate	1.0 g	(Inhibition of the flora accompanying coliforms)
Sodium chloride	5.0 g	
Dipotassium phosphate	2.0 g	
Ferric ammonium citrate	1.0 g	
Sodium citrate	1.0 g	
Bacteriological agar	15.0 g	
Neutral red	0.03 g	

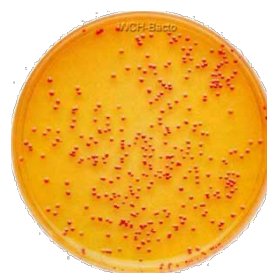
**SELECTIVE-DIFFERENTIAL MEDIUM FOR *Escherichia coli*. MET**

Sodium laurilsulphate and sodium desoxycolate are used as selective factors, in accordance with their properties to inhibit the development of Gram-positive cocci and sporulated bacteria. The differential nature of the method is provided by the chromogen 5-bromo, 6-chloro-indolyl- β -D-glucuronide.

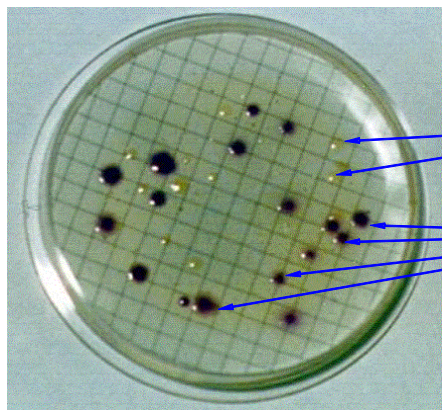

Other coliforms

Yellow

Escherichia coli

Magenta

SELECTIVE-DIFFERENTIAL MEDIAS FOR *Staphylococcus***Giolitti and Cantoni medium**

Composition (g) for 1 litre of medium:

Tryptone:	10,0
Meat extract:	5,0
Autolytic yeast extract:	5,0
Glycine :	1,2
Mannitol :	20,0
Sodium piruvate:	3,0
Sodium chloride:	5,0
Lithium chloride:	5,0
Tween 80 :	1,0
pH medium:	6,9 ± 0,2

Baird Parker solid medium

Composition (g/l)

Tryptone :	10,0
Meat extract:	5,0
Autolytic yeast extract:	1,0
Sodium pyruvate :	10,0
Glycine :	12,0
Lithium chloride:	5,0
Bacteriological agar:	20
Egg yolk emulsion:	47 ml
Potassium tellurite at 3,5 %:	3 ml
Sulfamehazine:	0,05 g/l (if necessary inhibit <i>Proteus</i>)
pH medium:	7,2 ± 0,2

**AROMATIC POLYCYCLIC HYDROCARBONS
DETERMINATION OF BENZO[a]PYRENE IN OENOLOGICAL
CHARBONS BY HPLC
OENO 18/2003**

1. PRINCIPLE

Polycyclic aromatic hydrocarbons including benzo[a]pyrene are extracted by hexane; the solvent is evaporated and the residue is taken up by the methanol-tetrahydrofuran for analysis by HPLC.

2. APPARATUS AND REAGENTS**2.1 Reagents and calibrations**

Acetonitrile for HPLC
Hexane for pesticide residues
Tetrahydrofuran for HPLC (THF)
Deionised and microfiltered water
Benzo[a]pyrene for HPLC.

2.2 Apparatus and chromatographic conditions

octadecyl type HPLC column
fluorimetric detector adjusted to the following detection conditions:

excitation wave length: 300 nm,
emission wave length: 416 nm.

Mobile phase:

solvent A: Deionised and microfiltered water
solvent B: acetonitrile

variations in the composition of the solvent

TIME in min	% solvent A	% solvent B
0	50	50
15	20	80
40	0	100
45	50	50

Flow 1.0 ml/mn

2.3 Preparation of reference solutions

Benzo[a]pyrene reference solution at about 100 mg/l in a methanol/THF mixture (50/50) stored for 3 years maximum in cold conditions.

Daughter solution at about 20 µg/l, prepared extemporaneous (0.5 ml of reference solution in 50 ml of methanol/THF then 1 ml of this intermediate solution in 50 ml de methanol/THF).

2.4 Preparation of samples

2 g of oenological charbon are mixed in a 50 ml volumetric flask with 30 ml of hexane.

The polycyclic aromatic hydrocarbons are extracted for 5 min using a magnetic stirrer. The organic phase recovered by filtration is gathered in a evaporating flask and evaporated. The extract is taken up by 2 ml of a methanol/THF mixture (1/1, v/v) and injected.

3. RESULTS

The benzo[a]pyrene content must not be higher than 1 µg/kg.

REMARK: It is also possible to determine benzo[a]pyrene by chromatography in gaseous phase by an apolar capillary column with detection by mass spectrometry.

**QUALITATIVE METHOD FOR DETECTION OF BIOGENIC AMINES
PRODUCED BY LACTIC ACID BACTERIA BY THIN-LAYER
CHROMATOGRAPHY (TLC)**

OIV/OENO 348/2010

1. PRINCIPLE

This method determines the ability to produce biogenic amines (BA) by bacteria in liquid culture media containing the corresponding amino-acid precursor. The method permits the separation and identification of the amines histamine (HIS), tyramine (TYR), putrescine (PUT), cadaverine (CAD) and phenylethylamine (PEA) using thin layer chromatography (TLC).

2. REAGENTS

2.1 Amino acids: L-histidine monohydrochloride, L-tyrosine di-sodium salt, L-ornithine hydrochloride, L-lysine monohydrate and L-phenylalanine;

2.2 Amines: histamine dihydrochloride, tyramine hydrochloride, 1,4-diaminobutane dihydrochloride, 1,5-diaminopentane dihydrochloride, β -phenylethylamine hydrochloride;

2.3 Dansyl chloride

2.4 Acetone

2.5 Chloroform

2.6 Triethylamine

2.7 Isopropanol

2.8 Triethanolamine

2.9 Thin-layer chromatography (TLC) plates (10 x 20 precoated plates with 0.20 mm silica gel 60 F₂₅₄)

3. STANDARD SOLUTIONS.

A stock of standard solutions is prepared by dissolving 0.2 g of each amine (HIS, TYR, PUT, CAD and PEA) in 10mL of 40% ethanol. The working standard solution is prepared by mixing 1 ml of each of these solutions and bringing it to a final volume of 10 mL with water.

Amines are converted to their fluorescent dansyl derivatives as follows: one volume of 250 mM Na₂HPO₄, 0.1 volume of 4N NaOH and 2 volumes of dansyl chloride solution (5 mg/mL dansyl chloride in acetone) are

added to one volume of the sample. The mixture is homogenized with a Vortex mixer and incubated at 55° C for 1 hour in the dark.

4. MICROORGANISMS AND GROWTH CONDITIONS.

O. oeni strains are cultured in pH 4.8 MRS broth (Merck), supplemented with 10% tomato juice. Strains of the genera *Lactobacillus* and *Pediococcus* are cultured in pH 6.3 MRS broth. All the bacteria are incubated at 30° C.

The broths are supplemented with biogenic-amine precursor amino acids such as histidine (5 mg/mL), tyrosine (5 mg/mL), ornithine (5 mg/mL), lysine (5 mg/mL), and phenylalanine (5 mg/mL). Samples are analysed after 9-12 days of growth.

5. TLC CONDITIONS.

The amines are fractionated on silica gel plates (silica gel 60 F254s). Amine-derivative extracts (10 µl) are applied 2 cm from the base of the plates with capillary pipettes. The dansylated compounds are separated by ascending development for 17 cm in chloroform:triethylamine (4:1). The spots are visualized under UV by using a transilluminator with a system for image acquisition. If a similar instrument is not available, the plate can be sprayed with isopropanol:triethanolamine (8:2) to enhance the fluorescence and visualized under a classical UV source.

The detection limit for the amines TYR, PUT, CAD and PEA is 0.01 mg/ml and the detection limit for HIS is 1 mg/mL. The method showed less sensitivity to HIS, however this detection level in the TLC method described is also adequate to detect HIS production when the bacteria is growing in a culture media supplemented with 5 mg/mL of histidine, as previously described.

6. ANALYSIS OF BIOGENIC AMINES FROM BACTERIAL CULTURES.

Bacterial strains are grown as described in section 4. After incubation, the broth media are centrifuged and the supernatants are analysed for BA content. Analysis of amines produced by bacterial strains is performed directly on bacterial supernatants as described above.

The separation order of the resulting amine spots from the top to the bottom of the plate are: PEA, TYR, HIS, CAD, PUT.

7. BIBLIOGRAPHY

1. Costantini A., Cersosimo M., Del Prete V., Garcia-Moruno E. (2006). Production of biogenic amines by lactic acid bacteria: screening by PCR, TLC and HPLC of strains isolated from wine and must. *Journal of food protection*, 69 (2): 391-396.
2. Garcia-Moruno E., Carrascosa A.V., Muñoz R. (2005). A rapid and inexpensive method for the determination of biogenic amines from bacterial cultures by thin-layer chromatography. *Journal of food protection*, 68 (3): 625-629.
3. Garcia-Moruno E. A method for the determination of biogenic amines from bacterial cultures by thin-layer chromatography (TLC), 2007 OIV FV 1243

BROMINE INDEX

OENO 18/2003

The bromine index is the quantity of bromine expressed in grammes, that 100 g of the substance can set.

1. APPARATUS

A graduated flask of 300 to 400 ml with an interior tube welded at the bottom, an emery stopper and a tube with a handle, compliant with the following diagram

**Bromination flask 300 ml in borosilicate glass.
Stopper with ground-glass joints
standardised 24/40.**

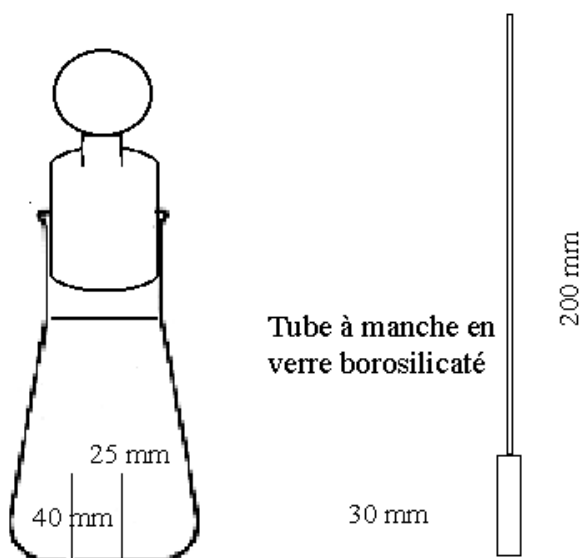

2. SOLUTIONS

2.1 Potassium bromate solution 0.016 M

This solution contains for 1000 ml:

Potassium bromate KBrO_3	2.783 g
-----------------------------------	---------

Weigh exactly 2.783 g of potassium bromate and introduce into a 1000 ml graduated flask containing about 500 ml of distilled water; shake in order to dissolve and complete to 20°C with distilled water the volume of 1000 ml of solution. Mix and store in a flask with a glass stopper.

2.2 Iodine solution 0.05 M

Iodine I	12.69 g
Potassium iodide de KI	18 g
Water q.s.p.	1000 ml

Weigh exactly 12.69 g of iodine, then 18 g of potassium iodide and introduce into a 1000 ml graduated flask with about 200 ml of distilled water. Allow the dissolution to operate in cold conditions with the flask being sealed. Add about 500 ml of distilled water, then shake to absorb the iodine in a vapour state and complete to 20°C with distilled water, the volume to 1000 ml of solution. Mix and store in a coloured glass flask with a glass stopper.

2.3 Sodium thiosulphate solution 0.1 M

The 0.1 M sodium thiosulphate solution contains for 1000 ml:

Sodium thiosulphate $\text{Na}_2\text{S}_2\text{O}_3 \cdot 5\text{H}_2\text{O}$	24.82 g
---	---------

Weigh exactly 24.82 g of sodium thiosulphate and introduce into a 1000 ml graduated flask containing about 600 ml of boiled distilled water. Shake to dissolve and complete to 20°C with boiled distilled water, the volume to 1000 ml of solution. Mix. Store away from light. Control the titre of this solution using the 0.05 M iodine solution.

3. TECHNIQUE

Using a tube with a handle, put about 0.50 g of potassium iodide in the recipient inside the flask; (it is convenient to make a circular mark on the tube corresponding to the salt's weight so as not to have to weigh each dosage). Caution has to be taken so as not to introduce iodide on the external part of the flask. Then introduce the measured

volume of the solution of the product to be measured, dissolved in neutral or alkaline water, in the external part of the flask, then 25 ml of potassium bromate solution 0.016 M measured with a pipette, and 2 g of pure potassium bromide. Rinse the sides with water to come to a total volume of about 100 ml, then add 5 ml of concentrated hydrochloric acid (R); quickly close the flask with the stopper, the joint being humid with distilled water; by a circular movement homogenise the content and allow to stand the prescribed time. Shake the flask *vigorously* so as to put the potassium iodide in contact with the liquid so as to enable the vapour bromine to react; open the flask while rinsing the joint and the stopper with a spray of distilled water, and determine iodine using 25 ml of sodium thiosulphate solution 0.1 M; titrate the excess of sodium thiosulphate with the iodine solution 0.05 M in the presence of starch paste;

Let n be the volume used:

Quantity of bromine (in mg) set by the substance to be dosed = $n \times 0.008$

DETERMINATION OF CADMIUM BY ATOMIC ABSORPTION SPECTROMETRY

OENO 18/2003

1. PRINCIPLE

The cadmium is determined in solid oenological products after mineralisation by wet process or directly for liquid oenological products or put in a solution.

The determinations are performed by atomic absorption without a flame (electro-thermal atomisation in a graphite oven).

2. APPARATUS

2.1 Instrumental parameters (given as an example)

Spectrophotometer equipped with an atomiser with a graphite tube.

wave length: 228.8 nm
hollow-cathode lamp (cadmium)
width of slit: 1 nm
intensity of the lamp: 3 mA
correction of continuum by the Zeeman effect
graphite oven with a tantalised platform
(tantalisation procedure of the platform described above)
adjusting the oven for an analysis:

step	temperature (°C)	time (s)	gas flow rate (/ mn	type of gas	reading of signal
1	100	35	3.0	argon	no
2	500	10	3.0	argon	no
3	500	45	1.5	argon	no
4	500	1	0.0	argon	no
5	2250	1	0.0	argon	yes
6	2250	1	0.0	argon	yes
7	2500	2	1.5	argon	no
8	1250	10	3.0	argon	no
9	75	10	3.0	argon	no

2.2 Adjustments of the automatic sampler (given as an example)

	volumes injected in μl		
	solution of Cd at 8 $\mu\text{g/l}$	blank	matrix modifier
blank	0	10	2
calibration N° 1 at 8 $\mu\text{g} / \text{l}$	1	9	2
calibration N° 2 at 16 $\mu\text{g} / \text{l}$	2	8	2
calibration N° 3 at 24 $\mu\text{g} / \text{l}$	3	7	2
calibration N° 4 at 32 $\mu\text{g} / \text{l}$	4	6	2
Sample to be dosed	5	5	2

3. REAGENTS

Demineralised water

Pure nitric acid for analysis at 65%

Anhydrous palladous chloride (59% in Pd)

Magnesium nitrate with 6 water molecules (ultra pure)

Ammonium dihydrogenophosphate

Matrix modifier: palladous chloride and magnesium nitrate mixture (dissolve 0.25 g of PdCl_2 and 0.1 g of $\text{Mg}(\text{NO}_3)_2 \cdot 6\text{H}_2\text{O}$ in 50 ml of demineralised water) or ammonium dihydrogenophosphate at 6% (dissolve 3 g of $\text{NH}_4\text{H}_2\text{PO}_4$ in 50 ml of demineralised water).

Cadmium reference solution at 1 g/l, commercial or prepared as follows: dissolve 2.7444 g $\text{Cd}(\text{NO}_3)_2 \cdot 4\text{H}_2\text{O}$ in a solution of HNO_3 0.5 M, adjust to 1 l with HNO_3 0.5 M.

Cadmium solution at 10 mg/l: place 1 ml of the reference solution in a 100 ml graduated flask, add 5 ml of pure nitric acid and complete to volume with demineralised water.

Cadmium solution at 0.8 g/l: place 4 ml of the diluted solution in a 50 ml graduated flask, add 2.5 ml of pure nitric acid and complete to volume with demineralised water.

Calibration range at 0, 8, 16, 24 and 32 $\mu\text{g/l}$ of cadmium.

4. PREPARATION OF SAMPLES

No preparation is necessary for liquid oenological products or in solution form; solid products are mineralised by wet process.

The blank solution is made up of a pure nitric acid solution for analysis at 1%.

5. PROCEDURE

Each calibration solution is passed right after the blank solution. Perform 2 successive absorbance readings and establish the calibration curve.

Calculate the cadmium content of the samples while taking into account the test sample of different dilutions.

**DETERMINATION OF CALCIUM BY
ATOMIC ABSORPTION SPECTROMETRY**

OENO 18/2003

1. PRINCIPLE

The calcium is directly determined in the liquid oenological product (or in the mineralisation solution) suitably diluted by atomic absorption spectrometry by air-acetylene flame after the addition of spectral buffer.

2. APPARATUS

Instrumental parameters (given as an example)

Atomic absorption spectrophotometer

Reducing air-acetylene flame

Hollow-cathode lamp (calcium)

wave length: 422.7 nm

width of slit: 0.2 nm

intensity of the lamp: 5 mA

No correction of non specific absorption.

3. REAGENTS**3.1 demineralised water**

3.2 calcium reference solution at 1 g/l, commercial or prepared as follows: dissolve 5.8919 g of $\text{Ca}(\text{NO}_3)_2 \cdot 4\text{H}_2\text{O}$ in a solution of HNO_3 0.5 M, adjust at 1 l with HNO_3 0.5 M.

3.3 calcium solution at 100 mg/l:

place 10 ml of the reference solution in a 100 ml graduated flask and 1 ml of pure nitric acid.

complete to volume with demineralised water

3.4 concentrated hydrochloric acid (R): 35% minimum**3.5 lanthanum solution at 25 g/l:**

weigh 65.9 g lanthanum chloride ($\text{LaCl}_3 \cdot 6\text{H}_2\text{O}$) in a 250 ml cylindrical vase, transfer to a 1000 ml graduated flask with demineralised water; add to the test tube 50 ml of concentrated hydrochloric acid (R); after solubilisation, allow to cool, complete to volume with demineralised water.

3.6 set of calibration solutions: 0, 2, 4, 6, 8 mg/l of calcium

place successively 0, 1,0, 2,0, 3,0 and 4.0 ml of the solution at 100 mg/l of calcium in 5, 50 ml graduated flasks, add 10 ml of lanthanum solution at 25 g/l, complete to volume with demineralised water.

4. PREPARATION OF SAMPLES

4.1 Case of liquid or solution oenological products

In a 50 ml graduated flask place 10 ml of the lanthanum solution and a volume of sample as after having being completed to volume with demineralised water; the concentration is below 8 mg/l.

4.2 Case of solid oenological products

Proceed with mineralisation by dry process;

Put in each solution of the set the same quantity of acid used for putting cinders in solution or mineralisation (see chapter "Mineralisation").

Take up cinders and 2 ml of concentrated hydrochloric acid (35% minimum) in a 100 ml flask; add 20 ml of lanthanum solution at 25 g/l and complete to volume with demineralised water.

Perform a blank test in the same conditions.

5. PROCEDURE

Pass each solution of the set in ascending order of the concentration of calcium.

For each solution, perform 2 absorbance readings when they are perfectly stabilised (integration time of signal: 10 seconds).

Pass each sample twice and calculate the calcium content.

SEARCH FOR CHLORIDES

OENO 18/2003

In a 160 × 16 mm test tube, place the volume prescribed of the solution obtained by the means indicated in each monography; add 5 ml of diluted nitric acid (R); complete to 20 ml and add 0.5 ml of silver nitrate solution at 5% (R).

Compare the opalescence or any cloudiness to the control sample prepared with 0.5 ml of hydrochloric acid at 0.10 g per litre (0.05 mg of HCl) with 5 ml of diluted nitric acid (R), and adjust to 20 ml with distilled water. Add 0.5 ml of silver nitrate solution at 5% (R). This tube contains 50 µg of HCl.

**DETERMINATION OF CHROME BY
ATOMIC ABSORPTION SPECTROMETRY**

OENO 18/2003

1. PRINCIPLE

The chrome is determined by atomic absorption spectrophotometer without flame.

2. APPARATUS**2.1 Experimental parameters** (given as an example)

Atomic absorption spectrophotometer

wave length: 357.9 nm

hollow-cathode lamp (Chrome)

width of slit: 0.2 nm

intensity of the lamp: 7 mA

correction of continuum by the Zeeman effect

introduction in hot conditions of the samples in the

graphite oven

measurement of the signal: peak height

time of measurement: 1 second

number of measurements per sample: 2

pyrolytic graphite tube:

pyrolytic graphite oven containing a platform L'Vov

tantalised

tantalisation of platform (see above)

inert gas: argon - hydrogen mixture (95%; 5%)

parameters for oven:

step	temperature (°C)	time (s)	gas rate flow (l / mn)	type of gas	reading of signal
1	85	5	3.0	argon + hydrogen	no
2	95	40	3.0	argon + hydrogen	no
3	120	10	3.0	argon + hydrogen	no
4	1000	5	3.0	argon + hydrogen	no
5	1000	1	3.0	argon + hydrogen	no
6	1000	2	0.0	argon + hydrogen	no
7	2600	1.2	0.0	argon + hydrogen	yes
8	2600	2	0.0	argon + hydrogen	yes
9	2600	2	3.0	argon + hydrogen	no
10	75	11	3.0	argon + hydrogen	no

2.2 Adjustments of the automatic sampler (given as an example)

	volumes injected in μl		
	chrome solution at 50 $\mu\text{g/l}$	blank	matrix modifier
blank	0	17	3
calibration N° 1 at 50 $\mu\text{g/l}$	5	12	3
calibration N° 2 at 100 $\mu\text{g/l}$	10	7	3
calibration N° 3 at 150 $\mu\text{g/l}$	15	2	3
sample to be measured	5	12	3

3. REAGENTS

3.1 pure demineralised water for analysis

3.2 pure nitric acid for analysis at 65%

3.3 anhydrous palladous chloride (59% in Pd)

3.4 pure hexahydrated magnesium nitrate for analysis

3.5 ammonium dihydrogenophosphate

3.6 matrix modifier: mixture of palladium chloride and magnesium nitrate (dissolve 0.25 g of PdCl_2 and 0.1 g of $\text{Mg}(\text{NO}_3)_2 \cdot 6\text{H}_2\text{O}$ in 50 ml of demineralised water) ammonium dihydrogenophosphate at 6% (dissolve 3 g of $\text{NH}_4\text{H}_2\text{PO}_4$ in 50 ml of demineralised water).

3.7 reducing agent: L-ascorbic acid in solution at 1% m/v.

3.8 chrome reference solution at 1 g/l, commercial or prepared as follows: dissolve 7.6952 g of $\text{Cr}(\text{NO}_3)_3 \cdot 9\text{H}_2\text{O}$ in a solution of HNO_3 0.5 M, adjust at 1 l with HNO_3 0.5 M

3.9 chrome solution at 10 mg/l: place 1 ml of the reference solution in a 100 ml graduated flask, add 5 ml of nitric acid at 65% and complete to volume with demineralised water.

3.10 set of calibration solutions: 0, 50, 100 and 150 $\mu\text{g/l}$ of chrome (see table: adjustments of the automatic sampler).

4. PREPARATION OF SAMPLES

4.1 Case of liquid or solution oenological products

The preparations are performed manually or automatically by the diluter by following the data from the table "adjustments of the automatic sampler".

4.2 Case of solid oenological products

Proceed with mineralisation by wet process. Do a blank test.

5. PROCEDURE

Pass each solution of the set in ascending order of the concentration of chrome;

Pass each sample twice and calculate the chrome content while taking into account the test sample.

SULPHURIC CINDERS

OENO 18/2003

The sulphuric cinders result from the calcination after being in contact with air after being attacked by sulphuric acid.

Heat a silica or platinum crucible of low form for 30 min until red; allow to cool in a vacuum desiccator and tare the crucible. Place the exactly weighed test sample in the crucible and wet it with a sufficient quantity of concentrated sulphuric acid (R) diluted beforehand by an equal volume of water. Heat until dry evaporation, then in a muffle oven, first carefully until red without exceeding the temperature of $600^{\circ}\text{C} \pm 25^{\circ}\text{C}$. Maintain calcination until the black particles disappear, allow to cool, add 5 drops of sulphuric acid diluted to half to the residue, then evaporate and calcinate as previously until constant weight; weigh after cooling in the desiccator.

Calculate the rate of sulphuric cinders referring to 100 g of substance.

TOTAL CINDERS

The total cinders result from the calcination of the product after contact with air.

Heat a silica or platinum crucible of low form for 30 min until red. Allow to cool in a vacuum desiccator and tare the crucible. Dispose homogeneously the exactly weighed test sample in the crucible. Desiccate for an hour in the incubator at 100°C - 105°C . Incinerate in the muffle oven, first carefully to avoid that the sample catches fire, then until red at a temperature of $600^{\circ}\text{C} \pm 25^{\circ}\text{C}$. Maintain the calcination until the black particles disappear. For 30 min allow to cool in a vacuum desiccator. Weigh. Continue the calcination until constant mass.

If the black particles persist, take up the cinders in hot distilled water. Filter these cinders on an ashless filter paper (porosity $10\ \mu\text{m}$). Incinerate the filter and residue until constant mass. Group the new cinders with the filtrate. Evaporate the water. Incinerate the residue until constant mass.

Calculate the rate of total cinders by referring to 100 g of substance.

**DETERMINATION OF COPPER BY
ATOMIC ABSORPTION SPECTROMETRY**

OENO 18/2003

1. PRINCIPLE

The copper is determined by atomic absorption spectrometry by flame by using the method of measured additions.

2. APPARATUS**Instrumental parameters:** (given as an example)

Atomic absorption spectrophotometer

flame: oxidant air-acetylene

wave length: 324.7 nm

hollow-cathode lamp (copper)

width of slit: 0.5 nm

intensity of the lamp: 3.5 mA

no correction of non specific absorption.

3. REAGENTS**3.1 pure demineralised water for analysis****3.2 pure nitric acid for analysis at 65%**

3.3 reference solution copper at 1 g/l, commercial or prepared as follows: dissolve 3.8023 g of $\text{Cu}(\text{NO}_3)_2 \cdot 3\text{H}_2\text{O}$ in a solution of HNO_3 0.5M, adjust at 1 l with HNO_3 0.5M.

3.4 copper solution at 10 mg/l: place 2 ml of the reference copper solution in a 200 ml graduated flask, add 2 ml of nitric acid at 65% and complete to volume with demineralised water.

Adjust apparatus using a calibration solution at 0.4 mg/l (2 ml of the copper solution at 10 mg/l in a 50 ml graduated flask, complete to volume with pure demineralised water for analysis).

4. PREPARATION OF SAMPLES (METHOD OF MEASURED ADDITIONS)

- Addition of 0.2 mg/l of copper:
place 5 ml of liquid oenological product or mineralisate of oenological product obtained by dry process in a flask and add 100 µl of the copper solution at 10 mg/l
- Addition of 0.4 mg/l of copper:
place 5 ml of liquid oenological product or mineralisate in a flask and add 200 µl of the copper solution at 10 mg/l
- dilution of the sample
Dilution of the sample: the dilution is only necessary if the copper content is more than 0.5 mg/l of copper.

5. PROCEDURE

- For each sample, pass in order:
- blank solution (demineralised water)
 - sample with 0.2 mg/l of copper
 - sample with 0.4 mg/l of copper
 - sample without addition
- the results are obtained automatically or by manual graph.

**ANALYSES OF GAS CONTROL BY
GASEOUS CHROMATOGRAPHY**
OENO 18/2003

1. PRINCIPLE

The gases are controlled by chromatography in gaseous phase using a "molecular sieve" type column and detection by catharometer or flame ionisation.

2. SAMPLING

Either use

- a stainless steel flask for sampling gas
- a Teflon sampling bag for gas.

3. INJECTION METHOD

Use of a unheated gas valve with a 250 µl ring.

4. SEPARATION OF LIGHT GASES, H₂, O₂, N₂, CO, CH₄.

4.1 Column (for example)

Phase: Molecular sieve Chromosorb 101, Porapak Q
diameter of particles 5µm
granulometry: 80 to 100 mesh
Dimensions: length: 2 m, internal diameter: 2 mm.

4.2 Vector Gas

Helium (He), flow: 3 ml/mn

4.3 Oven temperature: 40°C isotherm

4.4 Detector: Catharometer, Intensity 190 µA

5. SEPARATION OF LIGHT HYDROCARBONS

5.1 Column (for example)

Wide bore

Phase: apolar, diameter of particles: 5 µm
Length: 30 m, internal diameter: 0.53 mm

5.2 Vector gas

Nature: Helium, Flow: 3 ml/mn

Oven temperature 35°C to 200°C rise: 10°C/mn

5.3 Detector: Flame ionisation, temperature 220°C.

SEARCH FOR HEAVY METALS

OENO 36/2000;

OENO 18/2003

1. Principle of the method

Heavy metals react with the thiol function to form sulphurs. The coloration that results is compared to a standard.

2. Reagents**2.1 Ammonium acetate,****2.2 Lead nitrate (II),****2.3 Glycerol,****2.4 Methanol,****2.5 Sodium hydroxide, solution at 1 mole NaOH /l,****2.6 Hydrochloric acid at 37%,****2.7 Thioacetamide reagent (R):****2.8 Standard lead solution:**

2.8.1 Lead solution at 1000 µg/ml: dissolve 1.598 g of lead nitrate(II) in water and complete to 1000 ml.

2.8.2 Lead solution at 10 µg/ml. Add 10 ml of the solution 2.8.1 and complete to 1000 ml. To be prepared just before use.

2.9 Buffer solution, pH = 3.5: dissolve 6.25 g of ammonium acetate in 6 ml of water, add 6.4 ml of hydrochloric acid (2.6) and dilute with water until 25 ml.

3. Procedure

3.1 Test solution: pour 5 ml of buffer solution (2.9), 25.0 g of sample and about 15 ml of water into a 50 ml graduated flask. Complete with water up to the reference mark.

3.2 Coloured solutions:

3.2.1. Sample solution: mix 12.0 ml of test solution (3.1) and 2.0 ml of buffer solution (2.9) in a test tube.

3.2.2. Comparative solution: mix 2.0 ml of test solution (3.1), 2.0 ml of buffer solution (2.9), 0.5 ml of standard lead solution

(2.8.2), 4.5 ml of water and 5.0 ml of methanol in a test tube.

3.2.3. Control solution: mix 12.0 ml of test solution (3.1), 2.0 ml of buffer solution (2.9) and 0.5 ml of standard lead solution (2.8.2) in a test tube.

3.2.4 Comparison of colorations:
add 1.2 ml of thioacetamide reagent (2.7) in the 3 test tubes (3.2.1 to 3), mix and wait 2 minutes. Compare the coloration vertically in the light of day.

- the sample solution must not be darker than the comparative solution.
- the control solution must not be lighter than the comparative solution.

4. Results:

The conditions described in 3.2.4 are obtained if the heavy metal content is less than 10 mg/l expressed in lead and with a precision of 1 mg/l.

**DETERMINATION OF IRON BY
ATOMIC ABSORPTION SPECTROMETRY**OENO 36/2000;
OENO 18/2003**1. PRINCIPLE**

The iron is determined by atomic absorption spectrophotometry by flame.

2. APPARATUS**2.1 Instrumental parameters:** (given as an example)

atomic absorption spectrophotometry
flame: oxidant air-acetylene
hollow-cathode lamp (iron)
wave length: 248.3 nm
width of slit: 0.2 nm
intensity of the lamp: 5 mA
no correction of non specific absorption.

3. REAGENTS**3.1 pure demineralised water for analysis**

3.2 iron solution at 1 g/l, commercial or prepared as follows:
dissolve 7.2336 g of $\text{Fe}(\text{NO}_3)_2 \cdot 9\text{H}_2\text{O}$ in a solution HNO_3 0.5 M adjust at 1 l avec HNO_3 0.5 M.

3.3 iron solution at 100 mg/l

place 10 ml of the reference iron solution in a 100 ml graduated flask, complete with demineralised water pure for analysis

3.4 set of calibration solution: 2, 4, 6, 8 mg/l of iron

place successively 1.0, 2.0, 3.0 and 4.0 ml of the solution at 100 mg/l of iron in 4, 50 ml graduated flasks; complete to volume with pure demineralised water for analysis

Perform a blank without iron in the same conditions.

4. PREPARATION OF SAMPLES**4.1 Case of liquid or solution oenological products**

Each sample is diluted with demineralised water in order to have a concentration of iron between 0 and 8 mg/l.

4.2 Case of solid oenological products

Proceed with mineralisation by dry process.

Put in each solution of the set of calibration the same quantity of acid used for putting of cinders in solution; each sample is diluted with demineralised water in order to have a concentration of iron between 0 and 8 mg/l.

5. PROCEDURE

Pass successively the calibration solutions and the blank which will be demineralised water or a water-acid solution with concentrations used for samples of solid oenological products mineralised by dry process and perhaps diluted.

**DETERMINATION OF LEAD BY
ATOMIC ABSORPTION SPECTROMETRY**

OENO 18/2003

1. PRINCIPLE

After mineralisation of the sample in an acid medium, the lead is determined by spectrometry without flame (electro-thermal atomisation).

2. APPARATUS**2.1 Instrumental parameters:** (given as an example)

Atomic absorption spectrophotometer equipped with an

atomiser with a graphite tube

wave length: 283.3 nm

hollow-cathode lamp (lead)

width of slit: 0.5 nm

intensity of the lamp: 5 mA

correction of continuum: by Zeeman effect

introduction in hot conditions of the samples in the

graphite oven by an automatic distributor (rinsing water

contains 2 drops of Triton per litre)

measurement of signal: peak height

time of measurement: 1 second

number of measurements per sample: 2

pyrolytic graphite tube

pyrolytic graphite oven containing a platform of L'Vov

tantalised

(tantalisation of a platform: see above).

parameters for oven

temperature (°C)	time (s)	gas flow rate (l / min)	type of gas	Reading of signal
150	20.0	3.0	argon	no
150	35.0	3.0	argon	no
800	15.0	3.0	argon	no
800	30.0	3.0	argon	no
800	2.0	0.0	argon	no
2250	0.8	0.0	argon	yes
2250	1.0	0.0	argon	yes
2500	1.0	1.5	argon	no
1200	9.0	3.0	argon	no

75	10.0	3.0	argon	no
----	------	-----	-------	----

2.2 Adjustments of the automatic sampler (given as an example)

	volumes injected in μl		
	lead solution at 50 $\mu\text{g} / \text{l}$	blank	matrix modifier
blank	0	10	2
calibration N° 1	1	9	2
calibration N° 2	2	8	2
calibration N° 3	3	7	2
calibration N° 4	4	6	2
calibration N° 5	6	4	2
Sample to be measured	10	0	2

3. REAGENTS

3.1 Pure demineralised water for analysis

3.2 Pure nitric acid for analysis at 65%

3.3 Ammonium dihydrogenophosphate

3.4 Matrix modifier: ammonium dihydrogenophosphate at 6%.

Introduce 3 g of ammonium dihydrogenophosphate in a 50 ml graduated flask, dissolve and complete to volume with demineralised water.

Lead reference solution at 1 g/l commercial or prepared as follows: dissolve 1.5985 g of pure $\text{Pb}(\text{NO}_3)_2$ for analysis in a solution of HNO_3 0.5 M, adjust at 1 l avec HNO_3 0.5 M.

Lead solution at 10 mg / l: place 1 ml of the reference lead solution at 1 g/l in a 100 ml graduated flask; add 1 ml of nitric acid at 65% complete to volume with pure demineralised water for analysis.

Lead solution at 0.1 mg/l: place 1 ml of the lead solution at 10 mg/l in a 100 ml graduated flask, add 1 ml of nitric acid at 65%; complete to volume with pure demineralised water for analysis.

Set of calibration solutions: 0, 50, 100, 150, 200, 300 $\mu\text{g}/\text{l}$ of lead.

The automatic distributor cycle allows to directly inject these quantities of lead on the platform from the lead solution at 0.050 mg/l.

4. PREPARATION OF SAMPLES

The liquid or solution samples must have concentrations between 0 and 300 µg/l of lead.

The solid samples will be mineralised by wet process (attack by nitric acid).

The blank is made up of pure water for analysis containing 1% of nitric acid at 65%.

5. PROCEDURE

The calibration curve represents the variations of absorbencies depending on the concentrations enabling to calculate the lead content of the samples.

**DETERMINATION OF MERCURY BY THE GENERATION OF VAPOUR
AND ATOMIC FLUORESCENCE SPECTROMETRY**

OENO 18/2003

1 – FIELD OF APPLICATION

This method is applied to the analysis of mercury in oenological products in the concentration range of 0 to 10 µg/l.

2 – DESCRIPTION OF THE TECHNIQUE

2.1. Principle of the method

2.1.1. Mineralisation by the wet process of the oenological product to be analysed.

2.1.2. Reduction of the permanganate not consumed by hydroxylamine hydrochloride.

2.1.3. Reduction of mercury(II) into metal mercury by tin chloride (II).

2.1.4. Entrainment of mercury by a current of argon at room temperature.

Detreming mercury in the state of monoatomic vapour by atomic fluorescence spectrometry, with the wave length at 254 nm: the mercury atoms are excited by a mercury vapour lamp; the atoms thus excited reemit fluorescent radiation that enables to quantify the mercury present using a photonic detector placed at 90° in relation to excitation beam; detection by atomic fluorescence enables to obtain good linearity and eliminates memory effects.

2.2. Principle of the analysis (figure n°1)

The peristaltic pump draws up the tin chloride (II) solution, the blank (demineralised water containing 1% nitric acid) and the mineralised sample or calibration.

The metal mercury is entrained in the gas-liquid separator by a current of argon.

After going through the membrane of a dessicator, the mercury is detected by fluorescence.

Then the gaseous current goes through a potassium permanganate solution in order to trap the mercury.

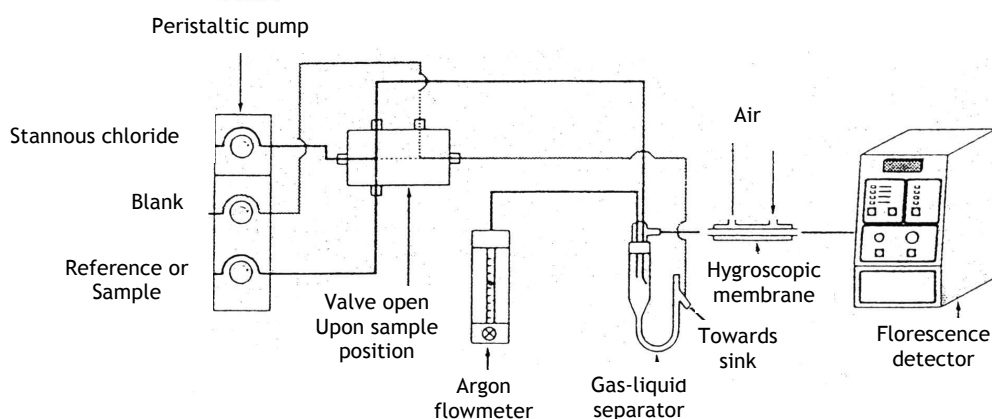

Figure n°1. Analytic Chain for dosage of mercury

3 – REAGENTS AND PREPARATION OF REAGENT SOLUTIONS

3.1. Ultra-pure demineralised water

3.2. Ultra-pure nitric acid at 65%

3.3. Blank: demineralised water (3.1.) containing 1% nitric acid (3.2.)

3.4. Nitric acid solution 5.6 M: introduce 400 ml of nitric acid (3.2.) into a 1000 ml flask; complete to volume with demineralised water (3.1.).

3.5. Sulphuric acid (d = 1.84)

3.6. Sulphuric acid solution 9 M: introduce 200 ml of demineralised water (3.1.) in a 1000 ml flask, then 500 ml of sulphuric acid (3.5.); after cooling, complete to volume with demineralised water (3.1.).

3.7. Potassium permanganate KMnO_4

3.8. Potassium permanganate solution at 5%: dissolve with demineralised water (3.1.), 50 g of potassium permanganate (3.7.) in a 1000 ml flask; complete to volume with demineralised water (3.1.).

3.9. Hydroxylamine hydrochloride $\text{NH}_2\text{OH}, \text{HCl}$

3.10. Reducing solution: weigh 12 g of hydroxylamine hydrochloride (3.9.) and dissolve in 100 ml of demineralised water (3.1.).

3.11. Tin chloride II ($\text{SnCl}_2, 2 \text{H}_2\text{O}$)

3.12. Concentrated hydrochloric acid

3.13. Tin (II) chloride solution: weigh 40 g of tin chloride (3.11.) and dissolve in 50 ml of hydrochloric acid (3.12.); complete to 200 ml with demineralised water (3.1.).

3.14 Mercury reference solution at 1 g/l prepared by dissolution of 1.708 g of $\text{Hg}(\text{NO}_3)_2 \cdot \text{H}_2\text{O}$, in 1 l of HNO_3 solution at 12% (m/n).

3.15. Mercury calibration solution at 10 mg/l, containing 5 % of nitric acid and prepared from the reference solution at 1 g/l (3.14).

3.16. Mercury solution at 50 µg/l: place 1 ml of the solution at 10 mg/l (3.14.) in a 200 ml flask; add 2 ml of nitric acid (3.2.); complete to volume with demineralised water (3.1.).

4 – APPARATUS

4.1. Glassware:

4.1.1. graduated flasks 100, 200 and 1000 ml (class A)

4.1.2. graduated pipettes 0.5; 1.0; 2.0; 5; 10 and 20 ml (class A)

4.1.3. precautions: before use, the glassware must be washed with nitric acid at 10%, left in contact for 24 hours, then rinsed with demineralised water.

4.2. **Mineralisation apparatus** (see Compendium of international methods of analysis of wines and musts)

4.3. Thermostatic **heating mantle**

4.4. **Peristaltic pump**

4.5. **Cold vapour generator**

4.5.1. gas-liquid separator

4.6. **Dessicator** (hygroscopic membrane) covered by an air current (supplied by a compressor) and placed before the detector

4.7. **Spectrofluorimeter:**

4.7.1. mercury vapour lamp, adjusted to the wave length of 254 nm

4.7.2. specific atomic fluorescence detector

4.8. **PC:**

4.8.1. software that adjusts the parameters of the vapour generator and atomic fluorescence detector and allows calibration and the analysis of results.

4.8.2. printer that archives results

4.9. **Bottle of neutral gas** (argon)

5. PREPARATION OF THE SET OF CALIBRATION SOLUTIONS AND SAMPLES

5.1. Set of calibration solutions: 0; 0.25; 0.5 and 1.0 µg/l

Introduce 0; 0.5; 1.0; 2.0 ml of the mercury solution at 50 µg/l (3.15.) in 4 100 ml flasks; add 1% nitric acid (3.2.); complete to volume with demineralised water (3.1.).

5.2. Samples

Mineralise the samples by wet process The test sample is introduced into the round-bottomed flask in borosilicate glass placed on a disc with a hole. The neck is inclined.

Add 5 ml of concentrated sulphuric acid (R) and 10 ml of concentrated nitric acid (R) and gently heat. When the mixture starts to turn brown, add a small quantity of nitric acid while continuing to heat and so forth until the liquid remains colourless and that the atmosphere of the flask fills with white smoke of SO₃. Allow to cool, take 10 ml of distilled water and heat again to allow the nitrous fumes to escape until the release of the white smoke. This operation is repeated; after a third time, boil an instant, cool, stabilise with several drops (about 10) of potassium permanganate (aqueous sol.) at 5% (m/m) and add water to the liquid to reach 40 ml.

Filter on filters without cinders. Introduce 10 ml of filtrate into a 50 ml flask. Add potassium permanganate (3.8.) until persistence of coloration. Solubilise the precipitate (MnO₂) with the reducing solution (3.10.). Complete to volume with demineralised water (3.1.).

Do a blank test with demineralised water.

6 – PROCEDURE

6.1. Analytical determination

Turn on the fluorimeter; the apparatus is stabilised after 15 minutes.

The peristaltic pump draws up the blank solution (3.3.), the tin chloride (II) solution (3.13.) and the calibrations or samples (5.1.) or (5.2.).

Check if there is a bubbling in the gas-liquid separator.

Present successively the calibration solutions (5.1.); start the programming of the vapour generator. The computer software sets up the calibration curve (percentage of fluorescence depending on the concentration of mercury in µg/l).

Then present the samples (5.2.).

6.2. Self-check

Every five determinations, an analytical blank solution and a calibration are analysed in order to correct a possible drift of the spectrofluorimeter.

7 – EXPRESSION OF RESULTS

The results are given by the computer software and are expressed in p.p.b. (or µg/l).

The concentration of mercury in oenological products is calculated according to the test sample and the dilution of the mineralisate. It is expressed in µg/kg.

8 – CONTROL OF RESULTS

The quality control is performed by placing, after the set of calibration solutions and all five samples, a reference material whose mercury content is known with certainty.

A control card is set up for each reference material used. The control limits are set at: $\pm 2S_R$ intra (S_R intra: standard deviation for reproducibility).

10 – BIBLIOGRAPHY

10.1. CAYROL M., BRUN S., 1975. Dosage du mercure dans les vins. Feuillet Vert de l'O.I.V. n°371.

10.2. REVUELTA D., GOMEZ R., BARDON A., 1976. Dosage du mercure dans le vin par la méthode des vapeurs froides et spectrométrie d'absorption atomique. Feuillet Vert de l'O.I.V. n°494.

10.3. CACHO J., CASTELLS J.E., 1989. Determination of mercury in wine by flameless atomic absorption spectrophotometry. Atomic Spectroscopy, vol. 10, n°3.

10.4. STOCKWELL P.B., CORNS W.T., 1993. The role of atomic fluorescence spectrometry in the automatic environmental monitoring of trace element analysis. Journal of Automatic Chemistry, vol. 15, n°3, p 79-84.

10.5. SANJUAN J., COSSA D., 1993. Dosage automatique du mercure total dans les organismes marins par fluorescence atomique. IFREMER, Rapport d'activité.

10.6. AFNOR, 1997. Dosage du mercure total dans les eaux par spectrométrie de fluorescence atomique. XPT 90-113-2.

10.7. GAYE J., MEDINA B., 1998. Dosage du mercure dans le vin par analyse en flux continu et spectrofluorimétrie. Feuillet Vert de l'O.I.V. n°1070.

**MINERALISATION METHODS OF SAMPLES BEFORE
DETERMINATION BY ATOMIC ABSORPTION SPECTROMETRY**

OENO 18/2003

1. MINERALISATION BY DRY PROCESS

Method applicable for determining the following elements: calcium, magnesium, sodium, iron, copper, zinc.

1.1 Obtaining cinders

Weigh with precision 5 g of oenological product (or 1 g in the case of products rich in mineral matters), in a platinum or silice capsule cleaned and tared beforehand.

Gently burn the sample with the flame of a Bunsen burner under a hood.

Put the capsule in a muffle oven at $525^{\circ}\text{C} \pm 25^{\circ}\text{C}$ for 12 hours.

Take up the residue with a few ml of demineralised water.

Evaporate water over a water bath at 100°C .

Replace the capsule containing the sample in the oven.

The mineralisation is over when the cinders are white.

1.2 Putting the cinders in a solution

The cinders are solubilised with 2 ml of concentrated hydrochloric acid (R), bring to volume at 100 ml with demineralised water

Complementary dilutions:

Re-dilute the cinders solution in hydrochloric acid in order to be compatible with the sensitivity of the apparatus; see separately the method of each cation.

For the determination of calcium and magnesium, add lanthanum chloride during this dilution.

Do a blank test.

2. MINERALISATION BY WET PROCESS

Method applicable for determining the following elements: arsenic, cadmium, lead in oenological products containing water.

2.1 Case of aqueous products

Weigh with precision in a 50 ml polypropylene tube 3 grammes of pulverised oenological product, add 5 ml of nitric acid at 65%; close with a screw cap; leave 12 hours at room temperature then after

unscrewing the cap place the tube in a water bath at 90°C for 3 hours under a hood; allow to cool; adjust the volume to 20 ml with demineralised water; shake; filter on an ashless filter paper (if necessary).

Do a blank test in the same conditions.

2.2 Case of dry products

The mineralisation is similar as for aqueous products but by using a test sample of 0.5 gramme of oenological product.

**DETERMINATION OF NICKEL BY
ATOMIC ABSORPTION SPECTROMETRY**

OENO 18/2003

1. PRINCIPLE

The nickel is directly determined by atomic absorption spectrometry without flame (electro-thermal atomisation).

2. APPARATUS

2.1 Instrumental parameters: (given as an example)

Atomic absorption spectrophotometer equipped with an atomiser with a graphite tube.

wave length: 232.0 nm

hollow-cathode lamp (nickel)

width of the slit: 0.2 nm

intensity of the lamp: 4 mA

correction of continuum by the Zeeman effect

introduction in hot conditions of the samples in the graphite oven with an automatic distributor

rinsing water contains 2 drops of Triton per litre.

measurement of signal: peak height.

Time of measurement: 1 second.

pyrolytic graphite tube:

pyrolytic graphite oven containing a platform of

L'Vov tantalised.

tantalisation of a platform: see above.

inert gases: argon and argon + hydrogen mixture (95%: 5%).

parameters for oven:

Parameters for oven for determining nickel

step n°	temperature (°C)	time (s)	gas flow rate (l/min)	type of gas	reading of signal
1	85	5.0	3.0	argon	no
2	95	40.0	3.0	argon	no
3	120	10.0	3.0	argon	no
4	800	5.0	3.0	argon	no
5	800	1.0	3.0	argon	no
6	800	2.0	0	argon	no
7	2 400	1.1	0	argon + hydrogen	yes
8	2 400	2.0	0	argon + hydrogen	yes
9	2 400	2.0	3.0	argon	no
10	75	11.0	3.0	argon	no

2.2 Adjustment of automatic sampler (given as an example)

- Parameters of automatic sampler

	volume injected in µl		
	solution of Ni at 50 µg/l	blank	matrix modifier
blank		17	3
calibration 1	5	12	3
calibration 2	10	7	3
calibration 3	15	2	3
sample	5	12	3

3. REAGENTS

3.1 Pure demineralised water for analysis

3.2 Pure nitric acid for analysis at 65%

3.3 Anhydrous palladium chloride (59% in Pd)

3.4 Pure hexahydrated magnesium nitrate for analysis

3.5 Ammonium dihydrogenophosphate

3.6 Matrix modifier: mixture of palladium chloride and magnesium nitrate (dissolve 0.25 g of PdCl₂ and 0.1 g of Mg(NO₃)₂.6H₂O (3.4) in 50 ml of demineralised water) ammonium dihydrogenophosphate at 6% (dissolve 3 g de NH₄H₂PO₄ in 50 ml of demineralised water), (3.1).

3.7 L-ascorbic acid

3.8 Analytical blank solution: L-ascorbic acid solution at 1% (m/v).

3.9 Nickel reference solution at 1 g/l (1000 µg/ml) off the shelf or prepared as follows: dissolve 4.9533 of Ni(NO₃)₂·6H₂O in a solution of HNO₃ 0.5 M, adjust at 1 l with HNO₃ 0.5 M.

4. PROCEDURE

Nickel solution at 10 mg/l: place 1 ml of the reference solution (3.8) in a 100 ml graduated flask, add 5 ml of nitric acid (3.2); complete to volume with demineralised water.

Nickel solution at 50 µg/l: place 1 ml of the nickel solution at 10 mg/l in a 200 ml graduated flask, 10 ml of nitric acid (3.2) and complete with demineralised water.

Set of calibration solution: 0, 50, 100 and 150 µg/l of nickel.

The automatic distributor cycle enables to perform this calibration on the platform from a nickel solution at 50 µg/l.

5. PREPARATION OF SAMPLES**5.1 Case of liquid or solution samples**

No preparation or sample dilution is necessary; the samples are placed directly in the cups of the automatic injector.

5.2 Case of solid samples

The solid samples are mineralised by dry process.

6. DETERMINATIONS

The calibration graph (absorbance depending on the concentration of nickel) gives the concentration of nickel in the samples.

**DETERMINATION OF POTASSIUM
BY ATOMIC ABSORPTION SPECTROMETRY**
OENO 18/2003

1. PRINCIPLE

The potassium is determined by mineralisation by dry process by atomic absorption spectrometry.

The addition of a spectral buffer (cesium chloride) to avoid the ionisation of the potassium is necessary.

2. APPARATUS

2.1 Glassware

100 and 200 ml graduated flasks (class A)
1, 2, 4 and 10 ml graduated pipettes (class A)
100 ml cylindrical vase

2.2 Instrumental parameters (given as an example)

atomic absorption spectrophotometer
oxidant air-acetylene flame (flow rate-air: 3 l/min, flow rate-acetylene: 1.8 l/min.)
Hollow-cathode lamp (potassium)
wave length: 769.9 nm
width of the slit: 0.5 nm
intensity of the lamp: 7 mA
no correction of non specific absorption.

3. REAGENTS

3.1 Pure demineralised water for analysis

3.2 Cesium chloride (CsCl)

3.3 Cesium chloride solution at 5% in cesium: Dissolve 6.330 g of cesium chloride in 100 ml of demineralised water.

3.4 Potassium reference solution at 1 g/l commercial or prepared as follows: dissolve 2.5856 g KNO₃ in water, adjust to 1 l.

3.5 Diluted potassium solution at 100 mg/l: Place 10 ml of the potassium reference solution at 1 g/l in a 100 ml graduated flask and 1 ml of pure nitric acid; complete to volume with pure demineralised water for analysis.

3.6 Set of calibration solution at 0, 2, 4, 6 and 8 mg of potassium per litre:

In a series of 100 ml graduated flasks, introduce 0; 2.0; 4.0; 6.0; 8.0 ml of the potassium solution at 100 mg/l ; add 2 ml of the cesium chloride solution to all the graduated flasks; adjust the volume to 100 ml with pure demineralised water for analysis.

The calibration solutions prepared contain 1 g of cesium per litre.

PREPARATION OF SAMPLES

4.1. Liquid or solution oenological products

In a 50 ml graduated flask, place 1 ml of the cesium chloride solution at 5% and a volume of a sample as is after having completed to volume with demineralised water; the concentration of potassium to be measured is below 8 mg/l.

4.2. Solid oenological products

Proceed with mineralisation by dry process (take cinders in 2 ml of hydrochloric acid in a 100 ml flask, add 2 ml of cesium chloride at 5% and complete to volume with demineralised water).

Perform a blank test with demineralised water.

5. DETERMINATIONS

Present successively the calibration solutions.

Perform an absorbance reading for 10 seconds; perform two measurements.

Set up the calibration curve (absorbance depending on the concentration in mg/l of potassium).

Then present the samples, perform an absorbance reading for 10 seconds; perform two measurements.

Calculate the concentration of potassium in the oenological products in mg/kg.

**DETERMINATION OF THE ABILITY OF AN ENZYMATIC
PREPARATION TO INTERRUPT PECTIC CHAINS BY MEASURING
VISCOSITY**

OIV/OENO 351/2009

1. PRINCIPLE

Here, it is proposed to measure the quantity of enzyme needed to halve the viscosity of a standard solution with a given pH, temperature and time.

This is a purely technological measurement designed to test the true clarifying efficiency of the enzyme. It essentially measures the pectinase activity, which cannot be directly deduced from the release of galacturonic acid in the medium.

Comment

To measure the enzyme's activity, there are two possible approaches:

- Either the time it takes a given concentration of the enzyme to halve the viscosity of the pectin solution,
- Or, the concentration of enzyme needed in order for the pectin solution's viscosity to be halved in a given period of time.

Tests show that, as long as the substrate is not limiting:

- In the first case, the viscosity logarithm (flow time) is inversely proportional to the reaction time and,
- In the second case, the viscosity logarithm is inversely proportional to the quantity of enzyme in the medium.

In either case, it is easy to find either the time or the quantity of enzyme needed to halve the viscosity on the basis of a judiciously chosen spectrum.

2. REAGENT CONDITIONS

70 mmol/l phosphate buffer medium 70 mmol/l and 30 mmol/l citrate
Substrate: 70-75 % esterified apple pectin (e.g. Sigma P 8471), diluted to 10 g/l in the buffer solution.

pH = 3.5

Temperature: 30 °C

Reaction time: 15 minutes.

Pectinase: spectrum of concentrations covering approximately 10 mg/l of enzyme dry weight in the sample; i.e., for example, 0.5 mg in 50 ml of substrate, which corresponds to the quantity of enzyme that is liable to halve the substrate's viscosity in 15 minutes in the conditions described above.

3. APPARATUS

- 3.1 Bath or water circulation thermostat (30 °C ± 1 °C)
- 3.2 Capillary flow viscometer (A.3.1: Fig. 2) with a water value (the time for water to flow between the two marks) of approximately 18 to 20 seconds (i.e. a capillary tube roughly 0.5 to 0.6 mm in diameter)
- 3.3 Timer
- 3.4 Analytical balance (sensitivity 0,001 g)
- 3.5 pH meter
- 3.6 Magnetic stirrer, conventional laboratory glassware
- 3.7 Rapid paper filters
- 3.8 Micro-pipettes or micro-syringes for dispensing volumes from 5 to 500 µl

4. PURE PRODUCTS

- 4.1 Pure citric acid (99,5 %)
- 4.2 Pure disodium hydrogenophosphate (Na₂ HPO₄·2H₂O) (99,0 %)
- 4.3 70-75 % esterified apple pectin with more than 90 % purity (e.g. Sigma P 8471)
- 4.4 Distilled or deionized water
- 4.5 Pure sodium hydroxide (98 %)
- 4.6 Pure hydrochloric acid (11.5 M) (33,5 %)
- 4.7 Pectinase the activity of which is to be measured.

5. SOLUTIONS

Each solution should be homogenised before using

- 5.1 2 M sodium hydroxide

Weigh out 80 g pure sodium hydroxide (4.5) in a 100-ml volumetric flask and dissolve in deionized water (4.4). Top up to the filler mark after complete dissolution and cooling.

5.2 2M hydrochloric acid

In a 100-ml volumetric flask half-filled with deionized water, place enough pure hydrochloric acid (4.6) to obtain a 2 M solution, (after having topped up to the filler mark).

5.3 47 mmol/l phosphate buffer, 53 mmol/l citrate, pH 3.5

5.3.1 Put 800 ml deionized water (4.4) in a 1,000-ml volumetric flask

5.3.2 Weigh out 11.22 g citric acid (4.1)

5.3.3 Weigh out 8.30 g pure disodium hydrogenophosphate ($\text{Na}_2 \text{HPO}_4 \cdot 2\text{H}_2\text{O}$) (4.2)

5.3.4 Transfer the quantitatively-weighed chemical products to the 1,000 ml volumetric flask, stirring all the time

5.3.5 Mix until completely dissolved

5.3.6 Adjust the pH to 3.50 ± 0.05 , at ambient temperature, with 2 M sodium hydroxide (5.1) or 2M hydrochloric acid (5.2), depending on the initial pH

5.3.7 Top up to the filler mark with deionized water (4.4). Mix

Stability: 8 days at ambient temperature.

5.4. Substrate: Apple pectin (4.3),

5.4.1 Put a 400-ml cylindrical container into a bath of water with a temperature of $40^\circ \text{C} \pm 3^\circ$ on a rotating stirrer

5.4.2 Add 250 ml of buffer with a pH of 3.5 (5.3), measured exactly, to the cylindrical container

5.4.3 Keep stirring gently at 40°C

5.4.4 Weigh out $2,500 \text{ g} \pm 0,01 \text{ g}$ of pectin (4.3)

5.4.5 Slowly add the pectin whilst stirring vigorously

5.4.6 Then stir slowly for 60 minutes, maintaining the temperature at 40°C

5.4.7 Stop stirring and cool to $30^\circ \text{C} \pm 3^\circ \text{C}$

5.4.8 Filter with rapid filter paper (3.8) if necessary (if lumpy)

Stability: 24 hours at ambient temperature.

5.5 100 g/l dry weight pectinase solution (4.7)

5.5.1 Weigh out $2.50 \text{ g} \pm 0.01 \text{ g}$ of powdered or granulated pectinase

5.5.2 Transfer to a 25-ml volumetric flask

5.5.3 Top up to the filler mark with buffer solution at pH 3.5 (5.3)

- 5.5.4 Dissolve by stirring for 20 minutes using a magnetic stirrer.
Filter through rapid filter paper if the enzyme is immobilised on an insoluble substance using a rapid filter (3.7)
- 5.5.5 In the case of a liquid enzymatic preparation, use it directly.

Stability: 4 hours at ambient temperature.

6. MEASUREMENTS

- 6.1 Put the viscometer in the bath of water at 30 °C or use any device that makes it possible to measure the viscosity at 30 °C.
- 6.2 Measure the viscosity (the flow time between the two marks on the viscometer) of the buffer solution at pH 3.5; that is, t_0 . This time should be approximately 20 seconds for a capillary tube 0.5 to 0.6 mm in diameter.
- 6.3 Measure the flow time of the 10 g/l pectin solution, that is, T_p . This time should be approximately 200 seconds or more.
- 6.4 Prepare a series of 4 volumetric flasks containing 50 ml of 10 g/l pectin and put them in the bath of water at 30 °C.
- 6.5 Add 5 μ l of the 100 g/l enzyme solution to the first flask and homogenize.
Then, approximately every 15 minutes, successively add to the other flasks:
15 μ l, 35 μ l and 100 μ l of the 100 g/l enzyme solution and homogenize.
- 6.6 Measure the time taken by the various solutions to flow between the two marks on the viscometer exactly 15 minutes after adding the enzyme.

7. GRAPHIC REPRESENTATION OF THE MEASURED VALUES

Deduct the t_0 value corresponding to the buffer at pH 3.5 alone from the flow time.
Produce a graph to represent the flow time logarithm as a function of enzyme concentration.
There must be at least three points in a line corresponding to the strongest dilutions. If this is not the case, use a more diluted enzyme solution - 50 g/l or even 10 g/l, for example.

8. INTERPRETATION OF THE RESULTS

Find the regression line equation passing through the three aligned points:

$$T = ax + b$$

Deduct from this the necessary concentration of enzyme C to halve the pectin solution's viscosity $(T_p - t_0)/2$; that is, $T_{0,5}$.

9. EXAMPLES

9.1 Determination of the necessary enzyme concentration to halve the viscosity of the pectin solution. (Table 1)

Flow time of the buffer alone $t_0 = 19.3$ s

Table 1:

Vol (μ l) of 100 g/l enzyme /50 ml of pectin	Concentration (g/l)	Flow time(s)	Corrected time(s)	Corrected time log.
0	0	230 (T_p)	210.7 ($T_p - t_0$)	2.32
5	0.01	190	170.7	2.23
25	0.05	107	87.7	1.94
100	0.2	32.8	13.5	1.13
500	1	23.8	4.5	0.65*

Corrected time = flow time – flow time of buffer with a pH of 3.5

* value not taken into consideration regression line equation (Fig.1)

$$y = -5.8366x + 2.2844$$

$$(T_p - t_0) / 2 = 105 \text{ s.}$$

$$\text{Log } 105 = 2.02 \rightarrow C = (2.28 - 2.02) / 5.84 = 0.044$$

Therefore, 0.044 g/l of enzyme are needed to halve the viscosity of a 10 g/l apple pectin solution at 30 °C during 15 minutes.

It has been shown that 1 g/l of enzyme was sufficient to almost totally reduce the viscosity of the pectin solution in 15 minutes.

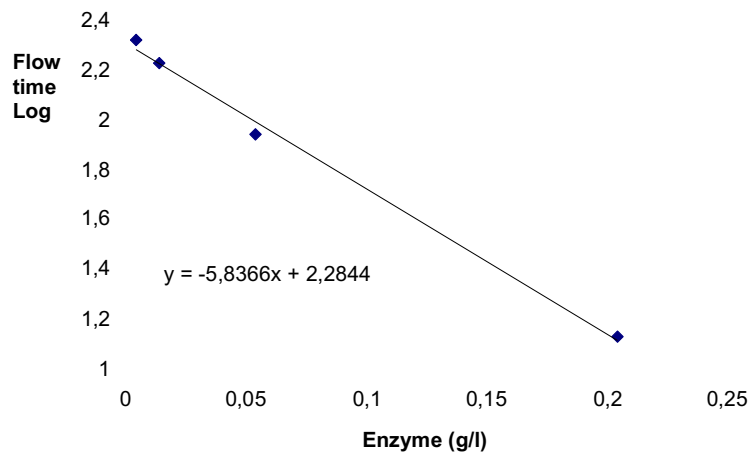

Fig.1 Reduction in the viscosity of a pectin solution as a function of enzyme concentration.

9.2 Reduction in the viscosity of a 10 g/l pectin solution as a function of the reaction time at 30 °C of an enzyme with a concentration of 0.1 g/l. (Fig. 2) – *For information only*

The buffer flow time was 19.6 seconds.

Table 2:

Reaction time (mn)	Flow time(s)	Corrected flow time(s)*	Flow time log.
0	170 (T _p)	150.7 (T _p - t ₀)	2.18
11.5	101.4	82.1	1.91
15.6	86	66.7	1.82
21.08	72.8	53.5	1.73
29	59.83	40.53	1.61
40.31	48.79	29.49	1.47
57	40.08	20.78	1.32
90	32.25**	12.95	1.11
167	26.25**	6.95	0.84

* Corrected flow time

**Values not taken into consideration since the remaining quantity of pectin limits the reaction.

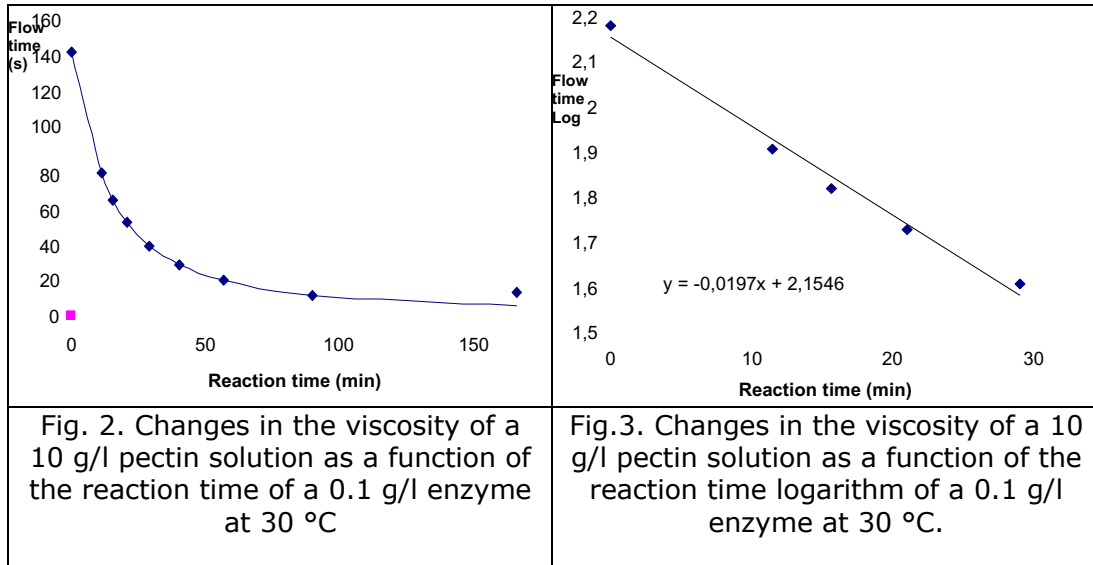

Interpretation of the results

The values in table 4 show that a $T/2$ reaction time of 13.3 minutes is needed to halve the viscosity of the 10 g/l pectin solution at 30 °C.

For the calculation, on the basis of the regression line in Fig. 3:

$$\text{Log}75.35 = 1.877$$

$$\text{Hence, } T_{0/2} = (2.1545 - 1.877)/0.0197 = 14.1 \text{ minutes.}$$

10. BIBLIOGRAPHY

Bertrand A. détermination de la capacité d'une préparation enzymatique de type polygalacturonase à couper les chaînes pectiques par la mesure de la viscosité OIV FV 1260

GRAPE SUGAR:

DETERMINATION OF SACCHAROSE BY HPLC

OENO 18/2003

1. PRINCIPLE

The samples diluted or put in solution are analysed by high performance liquid chromatography: Separation on column of grafted silica NH₂ and detection using a differential refractometer.

2. APPARATUS AND ANALYTICAL CONDITIONS (for example)

2.1 Chromatograph

- Grafted silica column NH₂ (length 20 cm, internal diameter 4 mm granulometry 5 µm)
- A pumping system
- An auto-sampler (maybe)
- Microfiltres with porosity 0.45 µm
- Differential refractometry detector

2.2 Chromatographic conditions (given as an example)

The water used is deionised and microfiltered.

The acetonitrile is of HPLC quality

The composition of the mobile phase is the following:

- If the column is new: acetonitrile/water (75/25)
- When the fructose - glucose resolution starts to deteriorate, the mobile phase is then a acetonitrile/water 80/20 mixture.

The flow is 1 ml/min.

3. REAGENTS AND CALIBRATION SOLUTIONS

3.1 Preparation of the reference solution

The chemicals used for the reference solution preparation are of "pure for analysis" quality.

The composition of this solution is about 10 g/l for each sugar (fructose, glucose and saccharose).

The reference solution is prepared every two weeks (maximum) and stored in the refrigerator in the 100 ml graduated flask used for the preparation.

**DETERMINATION OF SELENIUM BY
ATOMIC ABSORPTION SPECTROMETRY**

OENO 18/2003

1. PRINCIPLE

After mineralisation of the sample by wet process, the selenium is determined by atomic absorption spectrometry without flame (electro-thermal atomisation in the graphite oven).

2. APPARATUS**2.1 Glassware**

Graduated flasks 50, 100 ml (class A)
Graduated pipettes 1, 5 and 10 ml (class A)
Polypropylene tubes 50 ml with screw top.

2.2 Instrumental parameters: (given as an example)

Atomiser
Atomic absorption spectrophotometer equipped with an

atomiser
with a graphite tube.

wave length: 196.0 nm

hollow-cathode lamp (selenium)

width of slit: 1.0 nm.

intensity of the lamp: 10 mA

correction of continuum by the Zeeman effect

introduction in hot conditions of the samples in the
graphite oven with an automatic distributor (rinsing water
contains 2 drops of Triton per litre).

measurement of signal: peak height

time of measurement: 1 second

number of measurements per sample: 2

Pyrolytic graphite tube:

Pyrolytic graphite oven containing a platform of L'Vov
tantalised.

tantalisation of a platform: see given procedure
beforehand.

inert gas: argon.

parameters for oven: table I

Table I - Parameters for oven for determining selenium

step	temperature (°C)	time (s)	gas flow rate (l/min)	type of gas	reading of signal
1	85	5	3.0	argon	no
2	95	40	3.0	argon	no
3	120	10	3.0	argon	no
4	1 000	5	3.0	argon	no
5	1 000	1	3.0	argon	no
6	1 000	2	0	argon	no
7	2 600	0.8	0	argon	yes
8	2 600	2	0	argon	yes
9	2 600	2	3.0	argon	no

2.3 Automatic sampler parameters (table II)
(given as an example)

Table II - Parameters de automatic sampler.

	volumes injected in µl		
	solution	blank	matrix modifier
blank		17	3
calibration n°1 50 µg/l	5	12	3
calibration n°2 100 µg/l	10	7	3
calibration n°3 150 µg/l	15	2	3
sample	15	2	3

3. REAGENTS

3.1 Pure demineralised water for analysis

3.2 Pure nitric acid for analysis at 65%

3.3 Anhydrous palladium chloride (59% in Pd)

3.4 Pure hexahydrated magnesium nitrate for analysis

3.5 Ammonium dihydrogenophosphate

3.6 Matrix modifier: mixture of palladium chloride and magnesium nitrate (dissolve 0.25 g of PdCl₂ and 0.1 g of Mg(NO₃)₂·6H₂O in 50 ml of demineralised water) ammonium dihydrogenophosphate at 6% (dissolve 3 g de NH₄H₂PO₄ in 50 ml of demineralised water).

3.7 Selenium reference solution at 1 g/l, off the shelf or prepared as follows: dissolve 1.4052 g SeO₂ in a solution of HNO₃ 0.5 M, adjust at 1 l avec HNO₃ 0.5 M.

3.8 Selenium solution at 10 mg/l: place 1 ml of the reference solution at 1 g/l in a 100 ml graduated flask; add 5 ml of nitric acid at 65%; complete to volume with pure demineralised water for analysis

3.9 Selenium solution at 50 µg/l: place 0.5 ml of the selenium solution at 10 mg/l, 5 ml of nitric acid at 65% in a 100 ml graduated flask; complete to volume with pure demineralised water for analysis.

3.10 Set of calibration solutions: 0, 50, 100 and 150 µg/l of selenium.

The automatic distributor cycle enables to perform this calibration on the platform from the selenium solution at 50 µg/l.

4. PREPARATION OF SAMPLES

Weigh with precision a test sample of 1 to 3 g in the graduated tube; add 5 ml of nitric acid at 65%; close with the screw cap; leave 12 hours at room temperature; place the tube in a water bath at 90°C for 3 hours (the caps are unscrewed during the heating); allow to cool; adjust the volume to 20 ml with pure demineralised water for analysis.

5. DETERMINATIONS

Set up the calibration graph (absorbance depending on the concentration in µg/l of selenium); determine the concentration of selenium in the samples.

Calculate the concentration of selenium in the mineralisate, then in the sample in µg/kg.

**DETERMINATION OF SODIUM BY
ABSORPTION ATOMIC SPECTROMETRY**

OENO 18/2003

1. PRINCIPLE

The sodium is determined after mineralisation by dry process by atomic absorption spectrometry.

The addition of a spectral buffer (cesium chloride) to avoid ionisation of sodium is necessary.

2. APPARATUS

2.1 Glassware

Graduated flasks 50 and 100 ml (class A)

Graduated pipettes 2.0; 5.0; 10.0 ml (class A)

Automatic pipette 1000 µl

Cylindrical vase 100 ml.

2.2 Instrumental parameters: (given as an example)

Atomic absorption spectrophotometer

oxidant air-acetylene flame (rate-air: 3.1 l/mn; rate-acetylene: 1.8 l/mn)

wave length: 589.0 nm

hollow-cathode lamp (sodium)

width of slit: 0.2 nm

intensity of the lamp: 5 mA

no correction of non specific absorption

3. REAGENTS

3.1 Pure demineralised water for analysis

3.2 Pure nitric acid for analysis at 65%

3.3 Cesium chloride solution at 5% in cesium:

Dissolve 6.330 g of cesium chloride in 100 ml of pure demineralised water for analysis.

3.4 Sodium reference solution at 1 g/l commercial or prepared as follows: dissolve 3.6968 g NaNO₃ in water, adjust at 1 l.

3.5 Diluted sodium solution at 10 mg/l:

Place 1 ml of the reference solution at 1 g/l in a 100 ml graduated flask, 1 ml of nitric acid at 65%, complete to volume with pure demineralised water for analysis.

3.6 Set of calibration solutions 0; 0.25; 0.50; 0.75; 1.00 mg of sodium per litre:

In a series of 100 ml graduated flasks, place 0; 2.5; 5.0; 7.5; 10 ml of the diluted sodium solution; in all the graduated flasks add 2 ml of the cesium chloride solution and adjust the volume at 100 ml with pure demineralised water for analysis.

The calibration solutions prepared contain 1 g of cesium per litre; they are stored in polyethylene flasks.

PREPARATION OF SAMPLES**4.1. Liquid or solution oenological products**

In a 50 ml graduated flask, place 1 ml of the cesium chloride solution at 5% and a volume of sample after having been completed to volume with demineralised water, the concentration of sodium to be measured is below at 1 mg/l.

4.2. Solid oenological products

Proceed with a mineralisation by dry process (take up the cinders in 2 ml of hydrochloric acid in a 100 ml flask, add 2 ml of cesium chloride at 5% and complete to volume with demineralised water).

Perform a blank test with demineralised water.

5. DETERMINATIONS

Present successively calibration solutions.

Perform an absorbance reading for 10 seconds; perform two measurements.

Set up the calibration curve (absorbance depending on the concentration in mg/l of sodium).

Then present the samples; determine the concentration of sodium of the diluted samples in mg/l.

Calculate the concentration of sodium in the oenological products in mg/kg.

The dosages of air-acetylene flame are performed manually.

SEARCH FOR SULPHATES

OENO 18/2003

In a 160 × 16 mm test tube, place the volume prescribed of the solution obtained by the means indicated in each monography; add 1 ml of diluted hydrochloric acid (R); adjust to 20 ml with water and add 2 ml of barium chloride solution at 10% (R).

Compare the opalescence or any cloudiness to the control sample prepared with 1 ml of solution at 0.100 g of sulphuric acid per litre (i.e. 0.10 mg of H₂SO₄,) with 1 ml of diluted hydrochloric acid (R) and water until volume of 20 ml and 2 ml of barium chloride solution (R). This tube contains 100 µg of H₂SO₄.

TANTALISATION OF PLATFORMS OF L'Vov IN GRAPHITE

OENO 18/2003

**PREPARATION OF TANTALUM SOLUTION AT 6% (m/v)
ACCORDING TO THE ZATKA PROCESS**

Three grammes of tantalum powder are put in a 100 ml Teflon ® cylindrical vase.

Add 10 ml of hydrofluoric acid diluted to a half, 3 g of dehydrated oxalic acid and 0.5 ml of hydrogen peroxide at 30 vol.

Heat carefully to dissolve the metal.

Add a few drops of hydrogen peroxide as soon as the reaction slows down; when the dissolution is complete, add 4 g of oxalic acid and 30 ml of water.

The acid is dissolved and the solution is brought to 50 ml with ultra pure demineralised water.

Store this solution in a plastic flask.

TREATMENT OF GRAPHITE PLATFORMS

The platform is placed inside the graphite tube or used pyrolytic graphite tube. It is set to the unit of atomisation of the spectrophotometer.

A volume of 10 µl of tantalum solution is injected on the platform using an automatic distributor of samples;

Put the tantalum solution in the blank's position on the sample holder.

The temperature cycle is set according to the following programme:

drying at 100°C for 40 seconds

mineralisation at 900°C for 60 seconds

atomisation at 2600°C for 2.5 seconds

argon is used as an inert gas.

REFERENCE:

Zatka, Anal. Chem., vol 50, n° 3, March 1978.

DETERMINATION OF TOTAL NITROGEN

OENO 18/2003

1. APPARATUS

1.1 The apparatus used for separating NH_3 is either a distillation apparatus with a rectifying column or a distillation apparatus under a current of steam (diagram) made up of:

A 1 l flask **A** of borosilicate glass used as a boiler with a stopcock funnel for filling. It can be heated by a gas or electric furnace.

An adapter **C** which gathers the spent liquid from the bubbler **B**.

A bubbler **B** of 500 ml with an inclined neck; the supply tube must reach the lowest part of the flask. The out-going tube has an anti-entrainment ball that makes up the top part of the bubbler. A stop-cock funnel **E** allows to introduce the liquid to be treated and alkaline lye.

A cooler 30 to 40 cm long, vertical, with a ball with fine dowel bush on the tip.

A 250 ml conical flask for the distillate.

1.2 Mineralisation flask, 300 ml ovoid-shaped flask with a long neck.

2. REAGENTS

Concentrated sulphuric acid (R).

Mineralisation catalyser (R).

Sodium hydroxide solution at 30% (m/m) (R).

Boric acid solution at 4% (R).

Hydrochloric acid solution 0.1 M.

Mixed-based indicator with methyl red (R) and methylene blue.

The boiler must contain acidulated water by 1 per 1 000 of sulphuric acid. It is advisable to boil this liquid before any operation, with the drain cock P open to let the CO_2 escape.

3. PROCEDURE

In the mineralisation flask, introduce the test sample containing 4 to 50 mg of nitrogen. Add 5 g of mineralisation catalyser (R) and 10 ml of concentrated sulphuric acid (R), if the quantity of dry organic matter to be mineralised is below 500 mg. Increase these quantities if a higher quantity of organic matter must be used.

Heat in an open flame under a hood. The neck of the flask is maintained inclined until the solution becomes colourless and the walls of the flask are clear of carbonised products.

After cooling, dilute with 50 ml of water and cool; introduce this liquid in the bubbler **B** with the funnel **E**, then add 40 to 50 ml of sodium hydroxide solution at 30% (R) in order to obtain frank alkalisation of the liquid. Entrain the ammoniac with the vapour by gathering the distillate in 5 ml of boric acid solution (R) placed beforehand in a receiving conical flask with 10 ml of water, with the tip of the ampoule plunged into the liquid. Add 1 or 2 drops of mixed-based indicator and gather 70 to 100 ml of distillate.

Titrate the distillate with the hydrochloric acid solution 0.1 M until the indicator turns pink violet.

1 ml of 0.1 M hydrochloric acid solution corresponds to 1.4 mg of nitrogen.

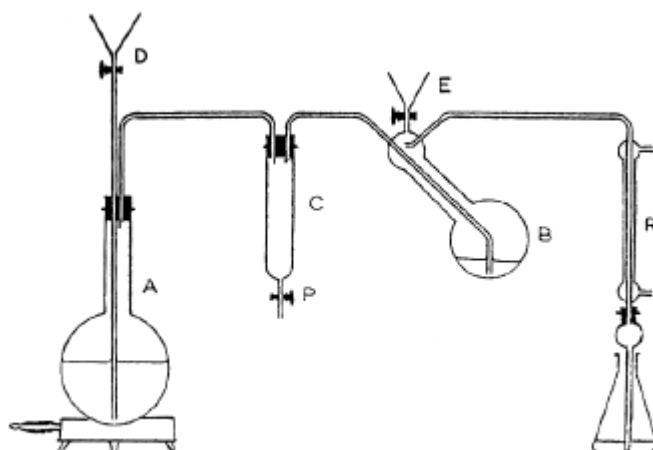

Apparatus for the distillation of ammoniac in a current of steam (PARNAS and WAGNER)

The cocks P and E can be replaced by a plastic pipe fitting with a Mohr pinch-clamp cock.

**DETERMINATION OF ZINC BY
ATOMIC ABSORPTION SPECTROMETRY**

OENO 18/2003

1 .PRINCIPLE

The zinc is determined directly by atomic absorption spectrometry by flame.

2. APPARATUS

Instrumental parameters: (given as an example)

atomic absorption spectrometer

oxidant air-acetylene flame

wave length: 213.9 nm

hollow-cathode lamp (zinc)

width of slit: 0.5 nm

intensity of the lamp: 3.5 mA

correction of the non specific absorption with a deuterium lamp.

3. REAGENTS**3.1 Pure demineralised water for analysis****3.2 Pure nitric acid for analysis at 65%**

3.3 Zinc reference solution at 1 g/l commercial or prepared as follows: dissolve 4.5497 g of $Zn(NO_3)_2 \cdot 6H_2O$ in a solution of HNO_3 0.5 M, adjust at 1 l with HNO_3 0.5 M.

3.4 Zinc solution at 10 mg/l:

place 1 ml of the zinc reference solution in a 100 ml graduated flask, 1 ml of nitric acid (3.2) and complete to volume with pure demineralised water for analysis.

3.5 Set of calibration solution: 0.2; 0.4; 0.6; 0.8; 1.0 mg/l: place successively 1, 2, 3, 4, 5 ml of the zinc solution at 10 mg/l in 5, 50 ml graduated flasks, complete to volume with pure demineralised water for analysis.

4. PREPARATION OF SAMPLES

The liquid or solution samples must have concentrations between 0 and 1 mg/l of zinc.

The solid samples are mineralised by dry process.

The blank solution is made up of pure water for analysis containing 1% of nitric acid at 65%.

5. PROCEDURE

Pass successively the blank, the calibration solutions and the samples of oenological products.

The absorbency readings are performed for 10 seconds and the measurements are duplicated.

The concentrations of zinc in the samples are obtained from absorbency values.

Chapter III
Reagents and
Titrated Solutions

List of reagents and titrated solutions¹Mention (R)²

OENO 19/2003

Acetic	crystallisable acid 98-100% diluted acid (10% m/m) neutral lead acetate (see Lead) potassium acetate (see Potassium) sodium acetate (see Sodium) uranyl and magnesium acetate
Starch	Paste (aqueous solution at 5 g/l)
Ammonium	concentrated hydroxide solution (20% NH ₃ , d(20/4)=0.92 diluted hydroxide solution (10 g concentrated solution/100 g) Aqueous hydroxide solution about 5 M chloride in solution at 20% (m/m) citrate in solution oxalate in solution at 4% (m/m) persulphate in solution at 15% (m/m)
Aniline	reagent
Silver	Nitrate (99.5%) nitrate solutions at 5% (m/m) (R1) Nitrate solution at 1% (m/m) (R2) ammonia nitrate solution
Barium	BaCl ₂ .2H ₂ O solution at 10% (m/m) chloride
Bore	boric acid, H ₃ BO ₃ 99% concentrated boric acid solution at 4% (m/v)
Bromine	Br ₂ (d(20/4)=3.12) bromine water

¹ this list does not contain the titrated acid solutions, sodium hydroxide, iodine, silver nitrate, etc.

² The composition of reagents "(R As)" is indicated for determining arsenic.

INTERNATIONAL OENOLOGICAL CODEX

Reagents and titrated solutions

COEI-3-REASOL: 2003

Bromophenol	tetrabromophenolsulfonephthaleine (blue) alcoholic solution (blue)
Bromothymol	dibromothymolsulfonephthaleine (blue) alcoholic solution (blue)
Bromocresol	tetrabromo-m-cresol-sulfonephthaleine (green) (green) alcoholic solution methyl red and (green) in solution (mixed indicator)
Calcium	acetate aqueous solution at 25% (m/v) chloride saturated solution chloride solution at 20% (m/v) hydroxide (milk of lime) saturated sulphate solution
Mineralisation catalyser	
Chloramine T	solution at 1% (m/v)
Chlorine	concentrated hydrochloric acid at 35% ($d(20/4)=1.19$) hydrochloric acid diluted at 30% (v/v) hydrochloric acid diluted at 10% (m/m) hydrochloric acid diluted at 10% (v/v) potassium dichromate (see Potassium)
Chrome	potassium dichromate (see Potassium)
Chromotropic acid	sodium salt sodium salt solution
Citric acid	Monohydrated 99% aqueous solution at 21% (m/m) aqueous solution at 20% (m/v) aqueous solution at 10% (m/v) aqueous solution at 5% (m/v) aqueous solution 0.003 M hydrochloric solution solution adjusted to pH 3

INTERNATIONAL OENOLOGICAL CODEX**Reagents and titrated solutions**

COEI-3-REASOL: 2003

Cobalt	chloride $\text{CoCl}_2 \cdot 6\text{H}_2\text{O}$ aqueous solution at 5% (m/m)
Copper	sulphate $\text{CuSO}_4 \cdot 5\text{H}_2\text{O}$ sulphate solution at 1 g of copper per litre sulphate solution at 0.01 g of copper per litre copper sulphate ammonia solution (II) alkaline copper reagent
Dichlorophenolindo phenol	sodium salt of 2,6-dichloro-N-(4- hydroxyphenyl)-1,4-benzoquinone monoimine dihydrate aqueous solution at 0.5 g per litre
Diphenylcarbazide	1,5-diphenylcarbonodihydrazide at 0.5 g per litre of alcoholic solution at 95% vol.
Dithizone	1,5-diphenylthiocarbazone solution at 0.5 g/l in chloroform extemporaneous preparation
Iron	iron sulphate (II) $\text{FeSO}_4 \cdot 7\text{H}_2\text{O}$ 99% iron sulphate (II) solution at 5% (m/m) iron sulphate (II) and ammonium $\text{Fe}(\text{NH}_4)_2(\text{SO}_4)_2 \cdot 6\text{H}_2\text{O}$ 98.5% iron sulphate (II) solution and ammonium at 10% (m/m) iron sulphate (III) $\text{Fe}_2(\text{SO}_4)_3 \cdot 7\text{H}_2\text{O}$ solution at 0.01 g of iron (III) per litre
Formaldehyde	aqueous solution at 35% (m/m)
Basic fuchsin	Mixture of rosaniline hydrochloride and pararosaniline hydrochloride Solution bleached by sulphur dioxide
Hydrazine	dihydrochloride aqueous solution
Hydrogen peroxide	concentrated solution at 30% (m/m) (=110 volumes) diluted solution 3% (m/m) (10 vol.)
Iodine	99.5%

INTERNATIONAL OENOLOGICAL CODEX**Reagents and titrated solutions**

COEI-3-REASOL: 2003

	iodine solution
Sodium indigo-sulphonate	(see sodium)
Mixed indicator	(see methyl red)
Magnesium	chloride $MgCl_2 \cdot 6H_2O$ 99% magnesian mixture
Mercury	mercury oxide (II), yellow mercuric oxide 99% mercury sulphate (II) solution
Metaphenylene-diamine	(see m-phenylenediamine)
Methyl (red)	(see red methyl)
Methyl orange	sodium 4(dimethylamino)azobenzene-4-sulfonate. Methyl orange alcoholic solution at 1% (m/v)
Molybdenum	reagent (see Nitric)
Naphthol	β -naphthol (2-naphtol) solution at 5% (m/m)
Nitric	concentrated acid 63% acid diluted at 10% (m/m) nitromolybdic reagent nitro-vanadomolybdic reagent lead nitrate (see Lead)
Eriochrome black T	Biting black 11 solution at 0.2% (m/v) in triethanolamine
Oxalic acid	acid $C_2O_4H_2 \cdot 2 H_2O$ 99% aqueous solution at 5% (m/m)
m-Phenylenediamine	dihydrochloride $C_6H_8N_2 \cdot 3 HCl$ 99%
Phenol (red)	(see phenol red)
Phenolphthalein	phenolphthalein solution at 1% in alcohol

	(m/v)
Phosphorus	<p>concentrated phosphoric acid (orthophosphoric acid) 85% d(20/4)=1.7 Diluted solution of phosphoric acid at 50% (m/m) Diluted solution of phosphoric acid at 25% (m/v) Dihydrogenophosphate (see Potassium)</p>
Lead	<p>neutral lead acetate $C_4H_6O_4Pb \cdot 3H_2O$ aqueous solution at 10% (m/m) (in water free from carbon dioxide) nitrate $Pb(NO_3)_2$ 99% lead nitrate aqueous solution at 1 g of lead per litre lead nitrate aqueous solution at 0.01 g of lead per litre</p>
Potassium	<p>acetate $C_2H_3KO_2$ 99% aqueous solution at 5% (m/m) anhydrosulphite $K_2S_2O_5$ (disulphite) 94% free from selenium potassium anhydrosulfite aqueous solution at 2% (m/m) cyanide KCN 98% aqueous solution at 10 g per 100 ml potassium cyanide aqueous solution at 1 mg of hydrocyanic acid per litre dichromate $K_2Cr_2O_7$ 99% aqueous solution at 10% (m/m) aqueous solution at 1 g of chromium per litre aqueous solution at 0.01 g of chromium per litre dihydrogenophosphate H_2KPO_4 99% aqueous solution at 0.05 g of phosphorous per litre hexacyanoferrate (II) $K_4Fe(CN)_6 \cdot 3 H_2O$ 98% aqueous solution at 5% (m/m) hydroxide KOH 85% aqueous solution at 40% (m/m); d(20/4) = 1.38 iodide KI 99% iodine potassium iodide solution</p>

INTERNATIONAL CENOLOGICAL CODEX

Reagents and titrated solutions

COEI-3-REASOL: 2003

	<p>permanganate KMnO_4 99% aqueous solution at 5% (m/m) aqueous solution at 3% (m/m) aqueous solution at 2% (m/m) aqueous solution at 1% (m/m) aqueous solution at 0.5% (m/m) aqueous solution at 0.2% (m/m) potassium permanganate phosphoric solution saturated aqueous solution thiocyanate KSCN 99% aqueous solution at 5% (m/m)</p>
Pyridine-pyrazolone	reagent
Quinine	<p>sulphate $\text{C}_{40}\text{H}_{48}\text{N}_4\text{O}_4 \cdot \text{H}_2\text{SO}_4 \cdot 2 \text{H}_2\text{O}$ 99% quinine sulphate sulphuric solution at 0.1 mg per litre of sulphuric acid 0.05 M</p>
Rosaniline	<p>hydrochloride (see fuchsine) aqueous solution at 0.1 g per 100 ml</p>
Methyl red	<p>acid 4-dimethylamino-2-phenylazobenzoic red methyl alcoholic solution methyl red mixed indicator</p>
Phenol red	<p>phenolsulfonephtaleine 98% phenol red solution</p>
Selenium	<p>dioxide SeO_2 99% aqueous solution at 100 mg of selenium per litre</p>
Sodium	<p>acetate $\text{C}_2\text{H}_3\text{NaO}_2 \cdot 3 \text{H}_2\text{O}$ aqueous solution at 10% (m/m) borate (tetraborate) $\text{Na}_2\text{B}_4\text{O}_7 \cdot 10 \text{H}_2\text{O}$ 99% saturated aqueous solution decahydrate carbonate $\text{Na}_2\text{CO}_3 \cdot 10 \text{H}_2\text{O}$ 99% aqueous solution at 25% (m/m) diethyldithiocarbamate $\text{C}_5\text{H}_{10}\text{NS}_2\text{Na} \cdot 3 \text{H}_2\text{O}$ 99% alcoholic solution at 1% (m/v) ethylenediaminetetracetate (disodic edetate) $\text{C}_{10}\text{H}_{14}\text{N}_2\text{O}_8\text{Na}_2 \cdot 2 \text{H}_2\text{O}$ 98.5% aqueous solution 0.01 M</p>

	fluoride NaF 98.5 % aqueous solution at 4% (m/m) concentrated hydroxide solution (caustic soda) at 30% (m/m); $d(20/4)=1.33$ diluted aqueous solution of sodium hydroxide at 10% (m/m) hydrogenophosphate (disodic dihydrate phosphate) $\text{HNa}_2\text{PO}_4 \cdot 2 \text{H}_2\text{O}$ 99.5% aqueous solution at 10% (m/m) pyrophosphate $\text{Na}_4\text{P}_2\text{O}_7 \cdot 10 \text{H}_2\text{O}$ (diphosphate decahydrate tetrasodium) 98% aqueous solution at 1% (m/m) thiosulphate $\text{Na}_2\text{S}_2\text{O}_3 \cdot 5 \text{H}_2\text{O}$ 99% aqueous solution at 25% (m/v) disodic indigo-sulphonate (see indigo carmine) indigo carmine solution
Hydrogen sulphide	saturated aqueous solution acid aqueous acid solution at 1 g of sulphur per litre aqueous acid solution at 0.01 g of sulphur per litre
Sulforesorcinic Sulphuric	reagent concentrated acid 95% $d(20/4)=1.83$ concentrated acid 97% (m/m) aqueous solution at 25% (m/m) aqueous solution diluted at 10% (m/m) aqueous solution diluted at 5% (m/m) acid free from nitrogen
Buffers	purified acetate (search for zinc) ammoniac pH 7.5
Tannin	definition aqueous solution at 2% (m/m) aqueous solution at 4% (m/v) aqueous solution at 10% (m/m)
Thioacetamide	reagent
Uranyl	nitrate $\text{UO}_2(\text{NO}_3)_2 \cdot 6 \text{H}_2\text{O}$ 99%

INTERNATIONAL OENOLOGICAL CODEX

Reagents and titrated solutions

COEI-3-REASOL: 2003

aqueous solution at 4% (m/m)
uranyl acetate $\text{UO}_2(\text{CH}_3\text{COO})_2 \cdot 2 \text{H}_2\text{O}$ 99%
magnesium and uranyl acetate and acetate
solution

Bromocresol green (see Bromocresol)

Bromocresol green and methyl red (see Bromocresol)

Zinc Solution 1 mg per litre

REAGENTS AND TITRATED SOLUTIONS**Crystallisable acetic (acid)**

ρ_{20} = 1.051; contains as a minimum 98.0% (m/m) of $C_2H_4O_2$.

Diluted acetic (acid)

Aqueous solution containing about 10 g of acetic acid in 100 g of reagent.

ρ_{20} = 1.0125 approximately.

Starch (paste) at 0.5% (m/v)

In a mortar, grind 2.5 g of soluble starch and 10 mg mercury iodide (II) with the necessary amount of water in order to obtain a fluid slurry. Introduce this in 500 ml of boiling water that is maintained 10 minutes. The liquid obtained is clear. Filter if necessary.

Concentrated ammonium hydroxide solution

ρ_{20} = 0.922.

Concentrated aqueous solution of ammonia gas containing about 20 g of ammonia (NH_3) in 100 g of reagent.

Diluted ammonium hydroxide solution

Aqueous solution of ammonia gas containing about 10 g of ammonia (NH_3) in 100 g of reagent.

ρ_{20} = 0.959 approximately.

Ammonium (chloride) in solution

Aqueous solution containing 20 g of ammonium chloride in 100 g of reagent.

Ammonium (citrate) in solution

Slowly pour 500 ml of concentrated ammonium hydroxide solution (R) in 400 g of citric acid in a 1000 ml graduated flask. The mass is heated and the dissolution is carried out. After cooling, complete the volume of 1000 ml with concentrated ammonium hydroxide (R).

Ammonium (hydroxide) in solution about 5 M

Dilute 460 ml of concentrated ammonium hydroxide (ρ_{20} = 0.922) with a sufficient amount of water to obtain 1 l.

Ammonium (oxalate) in solution at 4% (m/m)

Aqueous solution containing 4 g of diammonium oxalate in 100 g of solution.

Ammonium (persulphate) in solution at 15% (m/m)

Aqueous solution containing 15 g of ammonium persulphate for 100 g of solution.

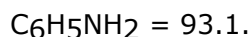
Aniline

The product used as a reagent must be clear and barely yellow.

$$\rho_{20} = 1.020 \text{ to } 1.023.$$

During distillation, 95% as a minimum must pass between 183°C and 185°C.

Silver (nitrate) in solution at 5% (m/m)

Aqueous solution containing 5 g of desiccated silver nitrate for 100 g of reagent.

Silver (nitrate) in solution at 1% (m/m)

Aqueous solution containing 1 g of desiccated silver nitrate for 100 g of reagent.

Silver (nitrate) in ammonia solution

Ammonia solution prepared with 10 g of desiccated silver nitrate for about 100 g of reagent.

In 30 g of distilled water, dissolve 5 g of desiccated silver nitrate. Pour into this solution, drop by drop with caution, the diluted ammonium hydroxide solution (R) until nearly total redissolution of the precipitated silver oxide. Complete to 50 ml, filter and store the reagent away from light in a flask with a glass stopper.

Barium (chloride) in solution at 10% (m/m)

Aqueous solution containing 10 g of $\text{BaCl}_2 \cdot 2\text{H}_2\text{O}$, for 100 g of reagent.

Concentrated boric (acid) in solution at 40 g per litre

This acid must be pure, entirely soluble in water (insoluble residue below 50 mg for 1 kg) and must not turn brown during incineration (absence of organic matters).

The aqueous solution at 40 g for 1 l of solution must be neutral to methyl orange. The orange coloration of this indicator must be obtained with less than 3 ml of hydrochloric acid solution 0.1 M for 1 l of this solution at 40 g per litre.

Boric acid that does not respond to these test trials can be purified by hot filtration of a boiling, saturated boric acid solution (at about 350 g per litre of water) and crystallisation by cooling.

Prepare a solution of 40 g of this concentrated acid for 1 l of solution.

Bromine (water)

Bromine saturated aqueous solution containing about 3.5 g of bromine for 100 ml at 20°C.

Bromophenol blue in solution

Alcohol solution at 95% vol. containing 0.04 g of bromophenol blue in 100 ml in total.

Bromothymol blue in solution

Alcohol solution at 95% vol. containing 0.04 g of bromothymol blue in 100 ml in total.

Calcium (acetate) at 25% (m/v)

Calcium acetate aqueous solution at 25 g for 100 ml.

Calcium (acetate) in solution pH 6

In a cylindrical vase place:

- calcium carbonate	10 g
- acetic acid	12 g
- water	100 ml

Heat until dissolution, adjust the pH to 6 and adjust to 1 l.

Calcium (chloride) in saturated solution

It contains about 80 g of $\text{CaCl}_2 \cdot 6\text{H}_2\text{O}$ for 100 g of solution.

Calcium (chloride) in solution at 20% (m/v)

Aqueous solution containing 20 g of crystallised calcium chloride $\text{CaCl}_2 \cdot 6\text{H}_2\text{O}$ in 100 ml of reagent.

Calcium hydroxide (milk of lime) at 10% (m/m)

The calcium hydroxide suspension (milk of lime) is obtained by treating 10 g of calcium oxide (quicklime) with 90 g approximately of boiling water.

Calcium (sulphate) in saturated solution

Saturated aqueous solution; it contains about 0.2 g of CaSO_4 for 100 g.

Mineralisation catalyser

Pulverise and mix:

- selenium	2.5 g
- copper sulphate (II)	5 g
- dipotassic sulphate	100 g

Chloramine T solution at 1% (m/v)

Aqueous solution containing 1 g of chloramine T (sodium salt of *p*-toluene N-chlorosulphanomide) for 100 ml of reagent.

Concentrated hydrochloric (acid)

Aqueous solution of hydrochloric acid (ρ_{20} = 1.18 to 1.19) containing 35.5 to 37.25 g of hydrochloric acid (HCl) in 100 g or 100 ml.

Hydrochloric (acid) diluted at 30% (v/v)

Dilute 300 ml of concentrated hydrochloric acid (ρ_{20} = 1.19) with a sufficient amount of water to obtain 1 l.

This solution contains about 13 g of HCl for 100 ml.

Hydrochloric (acid) diluted at 10% (m/m) (ρ_{20} = 1.0489)

Aqueous solution containing 10 g of hydrochloric gas (HCl) in 100 g.

Hydrochloric (acid) diluted at 10% (v/v)

Aqueous solution of hydrochloric acid containing about 10 ml of concentrated hydrochloric acid (R) in 100 ml, i.e. about 3.6 g HCl for 100 ml.

Chromotropic (acid)

1.8-dihydroxy-3.6-naphtalene-1.6-disulphonic acid
($C_{10}H_8O_8S_2 \cdot 2H_2O$ = 356.3).

White powder that turns brown in light, soluble in water. The disodium salt of this acid is generally used which is a yellow or light brown product and very soluble in water.

Chromotropic acid solution (sodium salt) at 0.05% (m/v)

Dissolve 60 mg of sodium salt of chromotropic acid in about 80 ml of water, complete to 100 ml with water. To be used within 24 hours.

Citric (acid) in solution at 21% (m/m)

Aqueous solution at 21 g for 100 g.

Citric (acid) in solution at 20% (m/v)

Aqueous solution of citric acid at 20 g for 100 ml.

Citric (acid) in solution at 10% (m/v)

Aqueous solution of citric acid at 10 g for 100 ml.

Citric (acid) in solution at 5% (m/v)

Aqueous solution of citric acid at 5 g for 100 ml.

Citric (acid) in solution 0.033 M

Solution containing exactly one tenth of the equivalent of a gramme of monohydrated citric acid per litre (i.e. 7.003 g per litre).

Citric (acid) in hydrochloric solution

Dissolve 150 g of concentrated monohydrated citric acid in 800 ml of water; add 100 ml of concentrated hydrochloric acid and add volume to 1 l.

Citric (acid) in solution to 5 g per litre adjusted to pH 3

Dissolve 5 g of citric acid in 900 ml of water. Add 8 ml of the sodium hydroxide solution 1 M and adjust to 1 l.

Cobalt (chloride) in solution at 5% (m/m)

Solution containing 5 g of cobalt chloride $\text{CoCl}_2 \cdot 6\text{H}_2\text{O}$ in 100 g of reagent.

Copper (II) (sulphate) solution at 1 g and 0.01 g per litre

The aqueous solution at 1 g of copper per litre contains 3.9295 g of copper sulphate ($\text{CuSO}_4 \cdot 5\text{H}_2\text{O}$) and 1 ml of concentrated sulphuric acid per litre. This solution is diluted to a hundredth to obtain the solution at 0.01 g of copper per litre.

Copper (sulphate) in ammonia solution

Copper sulphate $\text{Cu SO}_4 \cdot 5\text{H}_2\text{O}$	5 g
Water	500 ml
Concentrated ammonium hydroxide (R)	300 ml

Dissolve the copper sulphate in water. Add the ammonium hydroxide and homogenise.

Alkaline copper (reagent)

The titrated alkaline copper reagent contains for 1000 ml:

Copper, Cu	4.454 g
------------	---------

It is obtained by mixing the two solutions:

a) Copper solution (II), (C)

Weigh exactly 35 g of copper sulphate (R) and introduce into a 1000 ml graduated flask with about 500 ml of distilled water and 5 ml of concentrated sulphuric acid (R). Shake to dissolve and complete to 20°C with distilled water until the graduated line. Mix.

b) Alkaline tartaric solution, (T)

Weigh 150 g of sodium and potassium L-tartrate (R) and introduce in a 1000 ml graduated flask containing about 500 ml of hot distilled water. Shake to dissolve. Allow to cool and add 300 ml of concentrated sodium hydroxide solution (R) non carbonated.

Complete to 20°C with distilled water the volume of 1000 ml of solution. Mix.

10 ml of the solution C with 10 ml of solution T are brought to the boil with 0.05 g of inverted sugar, 0.048 g of pure glucose and 0.0695 g of anhydrous lactose or 0.073 g of hydrated lactose.

2.6-dichlorophenolindophenol in solution

Dissolve 0.50 g of 2.6-dichlorophenolindophenol in 200 ml of water heated at 90°C. Allow to cool and complete to 1000 ml with water. Filter.

Diphenylcarbazide in solution

Solution of 0.50 g of diphenylcarbazide in 1 l of alcohol at 95% vol.

Peroxide in diluted solution

See Hydrogen (peroxide).

Iron (II) (sulphate) in solution at 5% (m/m)

Solution prepared extemporaneously with boiled distilled water containing 5 g of iron sulphate (II) $\text{FeSO}_4 \cdot 7\text{H}_2\text{O}$ in 100 g of reagent (air oxidises it quickly).

Iron (III) (sulphate) in saturated solution

Prepare a saturated solution of iron sulphate (III) $\text{Fe}_2(\text{SO}_4)_3 \cdot 7\text{H}_2\text{O}$.

Iron (II) (and ammonium sulphate) in solution at 10% (m/m)

Aqueous solution containing 10 g of ammonium and iron sulphate (II) in 100 g of reagent.

Iron (III) (salt) in solution at 0.010 g of iron per litre

Dissolve 0.1 g of pure iron in 20 ml of water and 5 ml of concentrated H_2SO_4 (R). Heat, add 10 drops of concentrated HNO_3 (R) and bring to the boil for 10 minutes to peroxidise the iron. Adjust the volume to 1 l. Dilute 1/10.

Formaldehyde in solution

Aqueous solution with 35% (m/m) of formaldehyde.

Fuchsine bleached by sulphurous acid

8 g of potassium anhydrosulphite are dissolved in 150 ml of distilled water; add 30 ml of basic fuchsine solution at 1 per 1000 (m/v) in alcohol at 95% vol. and 55 ml of hydrochloric acid 3 M. Complete to 250 ml with distilled water. Store in a yellow flask with an emery stopper.

Hydrazine (dichlorhydrate) in solution

Hydrazine dichlorhydrate	500 mg
Water	q.s.f. 100 ml

Dissolve the hydrazine dichlorhydrate in about 80 ml of water, then adjust the volume to 100 ml.

Reagent to be prepared extemporaneously.

Hydrogen (peroxide) in solution to 3 volumes

This solution contains 9.1 g of H_2O_2 per litre; it liberates 3 times its volume of oxygen by catalytic decomposition by MnO_2 in an alkaline medium.

Iodine (solution)

Aqueous solution saturated with iodine.

Sodium indigo-sulphonate

Indigo-disulphonate sodium salt (improperly called indigo carmine): $\text{C}_{16}\text{H}_8\text{O}_8\text{S}_2\text{N}_2\text{Na}_2$

This product in solution at 10% (m/v) should turn yellow when oxidised by the potassium permanganate in a sulphuric environment; 50 ml of this solution requires 14 ml to 17 ml of potassium permanganate solution 0.02 M.

If, by permanganic oxidation, this solution does not turn yellow, it is advisable to purify the sodium indigo-sulphonate by the following process:

Put 10 g of sodium indigo-sulphonate in contact with 50 ml of concentrated sulphuric acid (R). After two days, add 100 ml of water;

filter the day after. Reject the rusty-coloured filtrate. Take up the residue with 100 ml of water, reject again the filtrate. Dissolve the residue with 800 to 1000 ml of acidulated water and 5 ml of concentrated sulphuric acid (R).

Indigo carmine solution: dissolve 0.2 of indigo carmine in a mixture of 10 ml of hydrochloric acid (R) and 990 ml of sulphuric acid solution free of nitrogen (R) to 200 g per litre.

Magnesium (chloride) in solution 0.01 M

Dissolve 0.45 g of pure magnesium oxide MgO in the necessary quantity of diluted hydrochloric acid (R). Bring to a litre. Titrate this solution using a sodium ethylenediaminetetraacetate solution 0.01 M in the presence of eriochrome black T.

Magnesian (mixture)

Dissolve 82 g of magnesium chloride ($MgCl_2 \cdot 6H_2O$) and 100 g of ammonium chloride in 800 ml of water. Add 400 ml concentrated ammonium hydroxide ($\rho_{20} = 0.92$) (R). Mix.

Mercury (II) (sulphate) in acid solution

Aqueous solution and mercury sulphate acid (II) $HgSO_4$. In a 200 ml graduated flask, introduce 10 g of yellow mercuric oxide, 120 ml of water and 75 g of concentrated sulphuric acid (R) (40 ml). After cooling, adjust the volume to 200 ml.

Metaphenylene-diamine (hydrochloride)

Grey-mauve amorphous powder: $C_6H_8N_2 \cdot 2 HCl$.

Methyl orange in solution

Solution prepared with alcohol at 90% vol. containing 1 g of methyl orange in 100 ml of reagent.

 β -naphthol in solution at 5% (m/m)

Dissolve 5 g of β -naphthol in 40 ml of concentrated ammonium hydroxide solution (R) and adjust the volume to 100 ml with distilled water. Prepare extemporaneously.

Concentrated nitric (acid)

$\rho_{20/4} = 1.39$

Concentrated nitric acid contains about 63% of nitric acid (HNO_3).

Diluted nitric (acid)

$\rho_{20/4} = 1.056$

Solution containing about 10 g of nitric acid (HNO_3) in 100 g of reagent prepared with 15.8 g of nitric acid (11.35 ml) ($\rho_{20} = 1.39$) at 63 g for 100 g and 84.2 g of water.

Nitromolybdic (reagent)

Dissolve 60 g of ammonium molybdate in 200 g of warm water. Filter if necessary. Slowly pour this solution in 720 g of diluted nitric acid while constantly shaking the latter. This diluted acid is obtained by mixing 370 g of concentrated nitric acid (R) with 350 g of water. Allow to stand 8 days. Adjust the volume to 1000 ml with distilled water. Filter or decanter.

This reagent, heated at 40°C, should not leave a deposit of precipitate.

Sensitivity: 25 μg of phosphorus for 5 ml.

Nitro-vanado-molybdic (reagent)

Prepare the following solutions

A) Solution of ammonium molybdate

Ammonium molybdate	100 g
Concentrated ammonium hydroxide (R)	10 ml
Distilled water	q.s.f.1000 ml

B) Solution of ammonium vanadate

Ammonium metavanadate	2.35 g
Distilled water	500 ml

Slightly heat to dissolve. After complete dissolution, cool and gradually add while shaking the following mixture:

Concentrated nitric acid (R)	7 ml
Distilled water	13 ml

Complete the volume to 1000 ml with distilled water. Mix.

To obtain the nitro-vanado-molybdic reagent, mix in a 500 ml graduated flask 67 ml of concentrated nitric acid (R), 100 ml of molybdic solution (A), 100 ml of nitro-vanadic solution (B) and adjust the volume to 500 ml. Mix.

Eriochrome black T in solution

Solution containing 0.2 g eriochrome black T in 100 ml of triethanolamine.

Oxalic (acid) in solution

Aqueous solution containing 5 g of crystallised acid oxalic $C_2O_4H_2 \cdot 2H_2O$ in 100 g of reagent.

Phenolphthalein in solution

Solution prepared with alcohol at 90% vol. containing 1 g de phenolphthalein in 100 ml of reagent.

Phosphoric (acid) solution at 85% (m/m)

Aqueous solution containing 85 g of orthophosphoric acid (H_3PO_4), $\rho_{20} = 1.70$, for 100 g.

Phosphoric (acid) solution at 25% (m/v)

Aqueous solution containing 25 g of phosphoric acid (H_3PO_4), $\rho_{20} = 1.70$, in 100 ml.

Phosphoric (acid) solution at 50% (m/m)

Aqueous solution containing 50 g of orthophosphoric acid (H_3PO_4), $\rho_{20} = 1.70$ in 100 g.

Phosphate (solution at 0.05 g of phosphorus per litre)**Potassium dihydrogenophosphate**

Dissolve 4.392 g of monopotassium phosphate (KH_2PO_4) in a sufficient quantity of water to obtain 1 l. This solution contains 1 g of phosphorus per litre. Dilute to the twentieth to obtain the solution at 0.05 g per litre.

Lead (nitrate) in solution at 1 g and 0.01 g of lead per litre

Dissolve 1.60 g of lead nitrate $\text{Pb}(\text{NO}_3)_2$ in a sufficient quantity of water to obtain 1 l of solution at 1 g of lead per litre. This solution is diluted to the hundredth to obtain the solution at 0.01 g of lead per litre.

Lead (neutral acetate) in solution at 10% (m/m)

Aqueous solution containing 10 g of lead acetate (II) $\text{Pb}(\text{C}_4\text{H}_6\text{O}_4) \cdot 3\text{H}_2\text{O}$ in 100 g of reagent.

Potassium sulfite**Potassium (acetate) in solution at 5% (m/m)**

Aqueous solution containing 5 g of crystallised potassium $\text{KC}_2\text{H}_3\text{O}$ acetate in 100 g of reagent $\text{CH}_3\text{CO}_2\text{K}$.

Potassium (anhydrosulphite) $\text{K}_2\text{S}_2\text{O}_5$ (formerly potassium disulphite) free from selenium.

To search for selenium in sulphur dioxide, potassium anhydrosulphite free from selenium should be used. To check the absence of selenium, proceed with the following test trial:

Weigh 2.55 g of the potassium anhydrosulphite sample, dissolve with heat in 7 ml of distilled water and 2 ml of concentrated hydrochloric acid (R). Allow to cool and add 3 ml of formaldehyde solute (R). Allow to stand 10 minutes. Place the tube in a water bath at 100°C and add 50 mg of the sample of pulverised potassium anhydrosulphite. The total sample is 2.60 g of potassium anhydrosulphite corresponding to 1.50 g of sulphur dioxide. A pink coloration should not develop.

Potassium (anhydrosulphite) in solution at 2% (m/m)

Aqueous solution containing 2 g of crystallised potassium anhydrosulphite in 100 g of reagent.

Potassium (cyanide) in solution at 1 mg of hydrocyanic acid per litre

Prepare an aqueous solution containing 2.44 g of KCN per litre, dilute to 1/100 to obtain the titrating solution of 1 mg of hydrocyanic acid per litre.

Potassium (dichromate) at 1 g and 0.01 g of chrome per litre

Dissolve 2.8283 g of potassium dichromate $K_2Cr_2O_7$ in a sufficient quantity of water to obtain 1 l of solution at 1 g of chrome per litre. This solution is diluted to the hundredth to obtain the solution at 0.01 g of chrome per litre.

Potassium (dichromate) in solution at 10% (m/m)

Aqueous solution containing 10 g of potassium dichromate in 100 g of reagent.

Potassium (hexacyanoferrate (II))/ potassium (ferrocyanide) in solution at 5% (m/m)

Aqueous solution containing 5 g of crystallised potassium $K_4Fe(CN)_6 \cdot 3H_2O$ hexacyanoferrate in 100 g of reagent.

Potassium (hydroxide) at 40%

Dissolve 40 g of potassium hydroxide (KOH) in a sufficient quantity of water to obtain 100 ml.

Potassium (iodide) in iodine solution

Iodine-iodide solution - aqueous iodine solution (I_2) in potassium iodide (KI).

In a tared flask with a glass stopper, introduce 2 g of iodine, 4 g of potassium iodide and about 10 g of water. Allow the dissolution to operate, then complete with water, the weight of 100 g.

Potassium (permanganate) in solution at 5% (m/m)

Aqueous solution containing 5 g of potassium permanganate (KMnO₄) in 100 g of reagent.

Potassium (permanganate) in solution at 3% (m/m)

Aqueous solution containing 3 g of potassium permanganate in 100 g of reagent.

Potassium (permanganate) in solution at 2% (m/m)

Aqueous solution containing 2 g of potassium permanganate in 100 g of reagent.

Potassium (permanganate) in solution at 1% (m/m)

Aqueous solution containing 1 g of potassium permanganate in 100 g of reagent.

Potassium (permanganate) in solution at 0.2% (m/m)

Aqueous solution containing 0.2 g of potassium permanganate in 100 g of reagent.

Potassium (permanganate) in saturated solution

Saturated aqueous solution containing about 6 g of potassium permanganate in 100 g of reagent.

Potassium (permanganate) at 5 per 1000 (m/m)

Aqueous solution containing 5 g of potassium permanganate in 1000 g of reagent.

Potassium (permanganate) phosphoric solution

Dissolve 3 g of potassium permanganate (R) in a mixture of 15 ml of phosphoric acid (R) and 70 ml of water; complete to 100 ml with water.

Potassium (thiocyanate) in solution at 5% (m/m)

Aqueous solution containing 5 g of potassium thiocyanate KSCN in 100 g of reagent.

Pyridine-pyrazolone (reagent)

Bis(1-phenyl-3-methyl-5-pyrazolone). (F. 320°C) - Dissolve 17.4 g of 1-phenyl-3-methyl-5-pyrazolone in 100 ml of alcohol at 95% vol., add 25 g of freshly distilled phenylhydrazine, bring to the boil under reflux for 4 hours. The mixture is filtered hot and the precipitate washed several times with alcohol at 95% vol.

The boiling under reflux could be prolonged beyond 4 hours if the occurrence of yellow crystals is not very abundant after this time.

Preparation of reagent pyridine-pyrazolone. – In a 100 ml graduated flask, introduce 0.150 g of 1-phenyl-3-methyl-5-pyrazolone and dissolve in 50 ml of alcohol at 95% vol. distilled on potassium hydroxide; complete to 100 ml with distilled water.

On the other hand, weigh 20 mg of bis(1-phenyl-3-methyl-5-pyrazolone), and dissolve by prolonged shaking in 20 ml of pyridine.

Mix the two resulting solutions by pouring them in a yellow glass flask wrapped in black paper. Store in the refrigerator.

Quinine (sulphate) in solution at 0.1 mg per litre of sulphuric acid 0.05 M

Dissolve 0.100 g of quinine sulphate in a sufficient quantity of sulphuric acid 0.05 M to obtain 1 l. Dilute three times 1/10 this solution with a sulphuric acid solution 0.05 M to obtain the solution at 0.1 mg of quinine sulphate per litre.

Rosaniline (hydrochloride) in solution discoloured by sulphurous acid

In a mortar, pulverise 30 mg of pure rosaniline hydrochloride, then add 30 ml of alcohol at 95% vol. The dissolution is rapid and complete. On the other hand, in a 250 ml graduated flask, dissolve 8 g of potassium anhydrosulphite in about 150 ml of distilled water. Add the alcoholic solution of hydrochloride rosaniline, then 55 ml of hydrochloric acid solution 3 M and bring to the graduation line with water. The reagent must be completely discoloured in less than an hour. It is stable for several months.

Methyl red in solution

Alcohol solution at 90% vol. containing 0.10 g of methyl red in 50 ml of reagent.

Methyl red mixed indicator:

Solution in alcohol at 90% vol. containing 0.10 g of red methyl and 0.05 g of blue methylene in 10 ml of reagent.

Phenol red in solution

Heat 0.05 g of phenol red with 2.85 ml of sodium hydroxide solution 0.05 M and 5 ml of alcohol at 90% vol. To the solution obtained, add a sufficient quantity of alcohol at 20% vol. to obtain 250 ml.

Selenium (dioxide) in solution at 100 mg of selenium per litre

Grind 2 g of pure selenium dioxide (SeO_2) and allow to stand for 24 hours in a desiccator for sulphuric acid. Weigh 1.4553 g of this dry dioxide and dissolve in a sufficient quantity of water to obtain 1 l of solution.

This solution contains 1 g of selenium per litre. Dilute 1/10 with distilled water to obtain the solution at 100 mg of selenium per litre.

Sodium (acetate) - $\text{NaC}_2\text{H}_3\text{O}_2 \cdot 3\text{H}_2\text{O}$ = 136.1.

The salt used as a reagent must be neutral.

Sodium (acetate) in solution at 10% (m/m)

Aqueous solution containing 10 g of sodium acetate $\text{NaC}_2\text{H}_3\text{O}_2 \cdot 3\text{H}_2\text{O}$ in 100 g of reagent.

Sodium (borate) in saturated solution

Saturated aqueous solution containing about 4 g of crystallised sodium borate for 100 g of solution. Sodium tetraborate $\text{Na}_2\text{B}_4\text{O}_7$.

Sodium (neutral carbonate) in solution at 25% (m/m)

Aqueous solution containing 25 g of crystallised disodic carbonate at 10 H_2O in 100 g of reagent $\text{Na}_2\text{CO}_3 \cdot 10\text{H}_2\text{O}$.

Sodium (diethyldithiocarbamate) in solution at 1% (m/v)

Dissolve 1 g of sodium diethyldithiocarbamate in a sufficient quantity of alcohol at 40% vol. to obtain 100 ml of solution $(\text{C}_2\text{H}_5)_2\text{NCS}_2\text{Na} \cdot 3\text{H}_2\text{O}$.

Sodium (ethylenediaminetetraacetate) in solution 0.01 M

Sodium ethylenediaminetetraacetate	4.0 g
Magnesium chloride, $\text{MgCl}_2 \cdot 6\text{H}_2\text{O}$	0.1 g
Water	q.s.f. 1000 ml

The titre of this solution must be checked and adjusted after titration by a calcium chloride solution 0.01 M obtained by dissolving 1 g of pure calcium carbonate in 25 g of concentrated hydrochloric acid (R) with 20 ml of water and by adjusting the volume to 1000 ml with distilled water.

Sodium (fluoride) in solution at 4% (m/m)

Aqueous solution containing 4 g of sodium fluoride (NaF) in 100 g of reagent. This solution is nearly saturated.

Sodium (hydroxide) in concentrated solution (caustic soda)

Aqueous solution with density 1.330 containing 30 g of sodium hydroxide (NaOH) in 100 g of solution.

Sodium (hydroxide) in diluted solution at 10% (m/m)

Aqueous solution containing 10 g of sodium hydroxide (NaOH) in 100 g of reagent.

Sodium (phosphate) in solution at 10% (m/m)

Aqueous solution containing 10 g of crystallised disodic phosphate in 100 g of reagent.

Sodium (pyrophosphate) at 1% (m/m)

Aqueous solution containing 1 g of crystallised tetrasodic pyrophosphate, $\text{Na}_4\text{P}_2\text{O}_7 \cdot 10\text{H}_2\text{O}$, in 100 g of reagent.

Sodium (thiosulphate) in solution at 25% (m/v)

Aqueous solution containing 25 g of sodium thiosulphate ($\text{Na}_2\text{S}_2\text{O}_3$) for 100 ml.

Hydrogen sulphide (acid) in saturated solution

Aqueous solution of saturated hydrogen sulphide acid. It contains about 3.8 g of H_2S per litre. It is alterable in air.

Hydrogen sulphide (acid) solution at 1 g of sulphur per litre and at 0.01 g per litre

Dissolve 7.5 g of $\text{Na}_2\text{S} \cdot 9\text{H}_2\text{O}$ in a sufficient quantity of water to obtain 1 l. This solution is diluted to a hundredth to obtain the solution at 0.01 g per litre (solutions rapidly oxidised by air).

Sulforesorcinic (reagent)

Dissolve 2 g of pure resorcinol in 100 ml of water and add 0.5 ml of concentrated sulphuric acid (R).

Sulphuric (acid) concentrated at 95% minimum

$\rho_{20/4} = 1.83$ to 1.84 . (H_2SO_4)

Sulphuric (acid) at 97% (m/m)

This absolutely colourless acid should not be able to be differentiated after heating at 120°C from an unheated control. It should be stored in flasks with emery stoppers. Its titre should be $97 \pm 1\%$.

Sulphuric (acid) at 25% (m/m)

$\rho_{20/4} = 1.1808$ approximately.

Aqueous solution of sulphuric acid containing about 25 g of acid H_2SO_4 in 100 g of reagent.

Sulphuric (acid) diluted at 10% (m/m)

$\rho_{20/4} = 1.0682$ approximately.

Aqueous solution of sulphuric acid containing about 10 g of acid H_2SO_4 in 100 g of reagent.

Sulphuric (acid) diluted at 5% (m/m)

Aqueous solution of sulphuric acid containing about 5 g of acid H_2SO_4 in 100 g of reagent.

Sulphuric (acid) free from nitrogen must satisfy the following test trial: nitrate. To 5 ml of water, carefully add 45 ml of sulphuric acid free from nitrogen, allow to cool to 40°C and add 8 mg of diphenylbenzidine. The solution is barely pink or pale blue.

Acetate buffer, purified, for search for zinc

Dissolve 136 g of sodium acetate in 440 ml of water, add 58 ml of concentrated acetic acid. Purify this solution by shaking with a dithizone solution at 125 mg per litre of chloroform.

Ammoniac buffer

Concentrated ammonium hydroxide	350 ml
Ammonium chloride	54 g
Distilled water	q.s.f. 1000 ml

Buffer pH 7.5

Monopotassium phosphate	94 g
Sodium hydroxide in molar solution	565 ml
Distilled water	q.s.f. 1 000 ml

Pure tannin

Tannin, called ether tannin or officinal tannin is extracted from the Aleppo gall.

It is in the form of a light mass, yellowish white, very soluble in water and alcohol at 90% vol. It is insoluble in ethylic ether. It must comply with the following test trials:

1. The aqueous tannin solution at 10% must be clear and have a very light yellow colour like white wine. The tannin solution at 10% in alcohol at 90% vol. must also be clear with hardly any colour.

A solution at 1 g of tannin in 5 g of water with its volume of alcohol at 90% vol. and half of its volume of ethylic ether, should give a clear solution (aqueous extract or alcoholic extract).

2. The officinal tannin must be combustible without leaving residue more than 0.05% (set mineral matters).

3. Desiccated at 100°C, the officinal tannin must not lose more than 12% in its weight (excess water). The anhydrous tannin content is calculated from this test trial. Its knowledge is necessary for the preparation of the solution at 4 per 1000.

Tannin in solution at 2% (m/m)

Aqueous solution containing 2 g of tannin in 100 g of reagent. It must be prepared extemporaneously.

Tannin in solution at 4% (m/v)

Dissolve a quantity of pure tannin containing 1 g of anhydrous tannin in a sufficient quantity of water to obtain 250 ml.

Tannin in solution at 10% (m/m)

Aqueous solution containing 10 g of tannin in 100 g of reagent.

Thioacetamide (reagent)

$F \cong 113^{\circ}\text{C}$

To 0.2 ml of aqueous thioacetamide solution at 40 g/l, add 1 ml of a mixture of 5 ml of water, 15 ml of sodium hydroxide 1 M and 20 ml of glycerol at 85% (m/m). Heat in a water bath at 100°C for 20 seconds. Prepare extemporaneously.

Uranyl (nitrate) in solution at 4% (m/m)

Solution containing 4 g of uranyl nitrate $\text{UO}_2(\text{NO}_3)_2 \cdot 6\text{H}_2\text{O}$ in 100 g of reagent.

Uranyl and magnesium (acetates) in hydro-alcoholic and acetic solution

Dissolve 32 g of crystallised uranyl acetate and 100 g of magnesium acetate in 300 ml of water, 20 ml of acetic acid and 500 ml of alcohol at 95% vol. by heating in a water bath at 100°C and by shaking; adjust the volume to 1 litre with water (distilled) and allow to stand 48 hours; decant or filter.

This reagent must be stored away from light. 2.5 ml of reagent must be used per milligramme of sodium to be precipitated and per millilitre of solution to be treated.

Phosphates, arseniates and fluorides must be absent from this solution. Heavy metals, iron (II) and alkaline-earth are not bothersome.

Bromocresol green in solution

Alcohol solution at 95% vol. containing 0.04 g of bromocresol green (3',3'',5',5''tetrabromo-*m*-cresolsulfonephtaleine) for 100 ml pf reagent.

Bromocresol green and methyl red in solution (mixed indicator)

Dissolve

Bromocresol green	0.04 g
Methyl red	0.06 g
in alcohol at 95% vol.	100 ml

Add 2.5 ml of sodium hydroxide solution 0.1 M.

This indicator from red (pH 4.6) turns blue-green with pH 4.9. It is violet with pH 4.75.

Zinc in solution at 1 mg per litre

Dissolve 1 g of pure zinc in the minimum concentrated hydrochloric acid (R) by gently heating. Dilute the solution to 500 ml and neutralise by adding sodium carbonate until a light precipitate appears which disappears when a few drops of hydrochloric acid are added.

Dilute successively three times 1/10 when using.

(All Rights Reserved) According to the law, the OIV declines all responsibility for involuntary errors or omissions that might occur, despite care taken in the editing. Reproduction of texts published in this work is forbidden. These texts are the property of OIV, which has the exclusive right to reproduce and translate these texts throughout the world. The law forbids copies and reproductions for group usage. Any representation or reproduction, whether complete or partial, by any means, without the accord of the OIV, is an unlawful act and constitutes an infringement of copyright.

© OIV – 2023

ISBN : 978-2-85038-063-1

INTERNATIONAL ORGANISATION OF VINE AND WINE

12, Parvis de l'UNESCO

21000 DIJON

Tél. (33) 01.44.94.80.80 - Tlc. (33) 01.42.66.90.63

E-mail: oiv@oiv.int - www.oiv.int